

---

# INSTRUCTION MANUAL

## Outdoor Patio Gazebo 8 ft x 8 ft

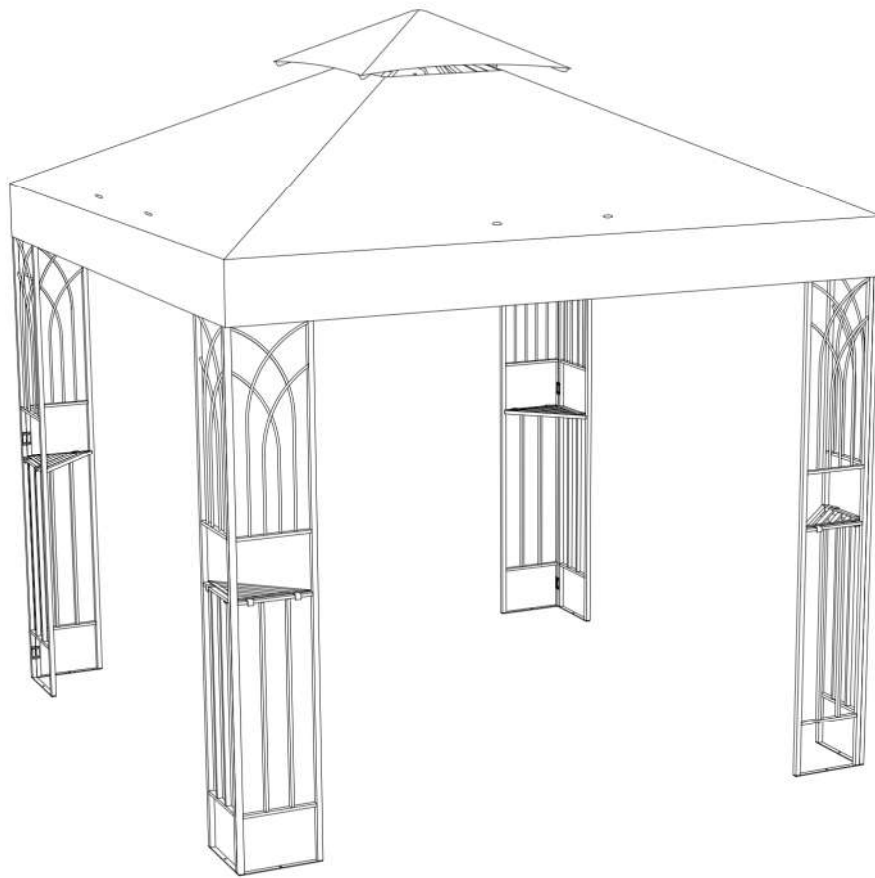



## LIMITED WARRANTY

We offer a limited warranty that this product is free from defects in materials and workmanship for a period of one (1) year from the original date of purchase. At its discretion, we may provide replacement parts for defective parts to original purchaser after its own review and examination. Original receipt or proof of purchase as well as proof of defect is required. We will not be responsible for shipping costs incurred outside the continental USA. Warranty is valid for the original purchaser for 1 year from the date of purchase and is not transferable. Regular maintenance of wood, aluminum, and steel components is required to assure the integrity of your product and is a requirement of the warranty. This warranty does not cover any inspection costs.

### **This Limited Warranty does not cover:**

- Labor for replacement of any defective item(s);
- Incidental or consequential damages;
- Cosmetic defects which do not affect performance or integrity;
- Vandalism; improper use or improper installation; acts of nature, including but not limited to wind, storms, hail, floods, excessive water exposure;
- Structural or component failure due to snow loading.
- Minor twisting, warping, checking, cracking, or any other natural occurring properties of wood that do not affect performance or integrity.

Our products have been designed for safety and quality. Any modifications made to the original product could damage the structural integrity of the product leading to failure and possible injury. We can not assume any responsibility for modified products. Furthermore, modification voids any and all warranties.

All replacement products or parts will assume the remaining warranty of the original product. This warranty gives you specific legal rights. You may also have other rights, which vary from state to state.

**This product is warranted for RESIDENTIAL USE ONLY. We disclaims all other representations and warranties of any kind, express or implied.**

**We do not warrant against and under no circumstances shall we be liable or responsible for any personal loss, injury, or direct or indirect incidental or consequential damages resulting from the use of this product**

*This Warranty gives you specific legal rights. You may have other rights as well which vary from state to state or province to province. This warranty excludes all consequential damages, do not allow the limitation or exclusion of consequential damages, and therefore this limitation may not apply to you, however, some states/provinces do not allow the limitation or exclusion of consequential damages, and therefore this limitation may not apply to you.*

**WARNING:**



**To reduce the risk of serious injury, read the following safety instructions thoroughly before assembling and using the gazebo.**

- Check with your local governing authority/local municipal codes regarding installation and permitting of such structures before assembly.
- Use of personal protective equipment including gloves, safety glasses, and closed toe footwear is recommended during assembly.
- Requires two or more people to assemble and install safely and correctly.
- The product is required to be installed on level solid surface and is not intended for unsecured use. The gazebo is to be anchored to the surface with appropriate bolts or anchors. These anchors need to be purchased separately for the specific installation surface. Do not assemble the gazebo on soil, earth, or bare ground.
- Ensure enough clearance around the product. Before assembling the product, find level ground no less than 6' (1.8 m) away from any structures or obstructions, such as fences, buildings, or overhead obstacles.
- Do not assemble or install the gazebo underneath electrical lines or above underground utilities.
- Check for underground utilities before digging or driving stakes into the ground.
- This gazebo is not to be regarded as part of a building/house structure.
- All assembly and maintenance of the product must be carried out by adults only.
- Use all power tools and hand tools in accordance with their respective safety manuals.
- Keep children and pets away while setting up the gazebo.
- Metal framed gazebos are NOT flame retardant and will burn. Grills, firepits, and chimneas create a fire hazard and should not be placed under or near your structure.
- Do not hang heavy weights from the roof frame.
- Do not climb onto the roof of the gazebo for any reason.
- Check all nuts and bolts monthly to ensure bolts/nuts are tightened.
- Check the metal hardware monthly to ensure there are no exposed sharp edges or rust. Sand sharp edges or rust with sandpaper and apply touch up paint. Always use lead free paint that conforms to 16 CRF Part 1303.

---

Needed for assembly: (The following tools are not included)











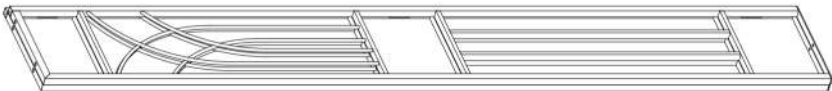

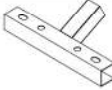
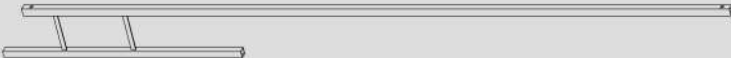

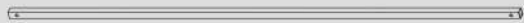
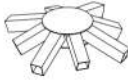
Ladder

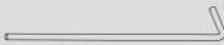

Two people

## Part List

Label	Description	Sketch	QTY
A	Screen Panel		4
B	Beam		8
C	Beam Connector		4
D	Corner Ceiling		4
E	Corner Bracket		4
F	Middle Ceiling		4
G1	Peak Connector		1
G	Hook		1
H	Corner Shelf		4
J	Small Top Cover		1
K	Big Top Cover		1
M	Stake		8
N	Bolt N	 M6*15	16
O	Bolt O	 M6*35	16
P	Allen Key		1

# Step 1

A\_Screen Panel\_4 pcs

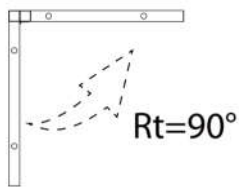
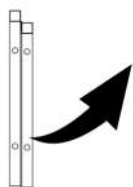
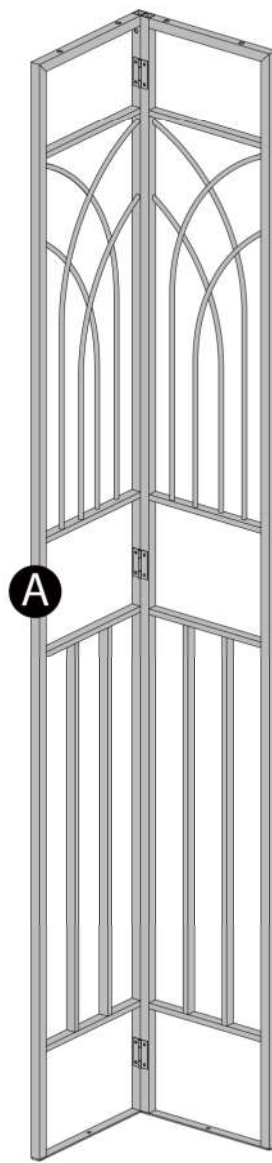
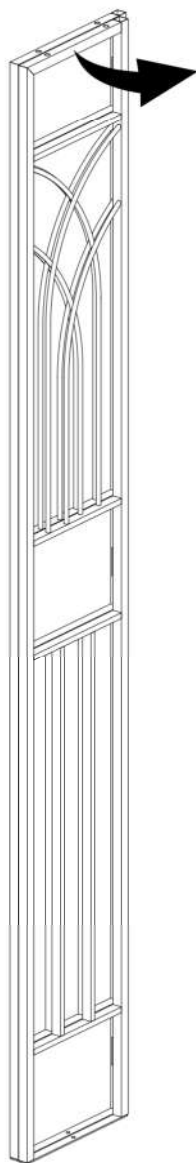
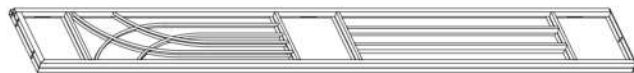

## Step 2

B\_Beam\_8 pcs



C\_Beam Connector\_2 pcs

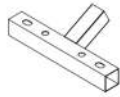

E\_Corner Connector\_4 pcs



N\_Bolt N\_8 pcs



M6\*15

O\_Bolt O\_16 pcs



M6\*35

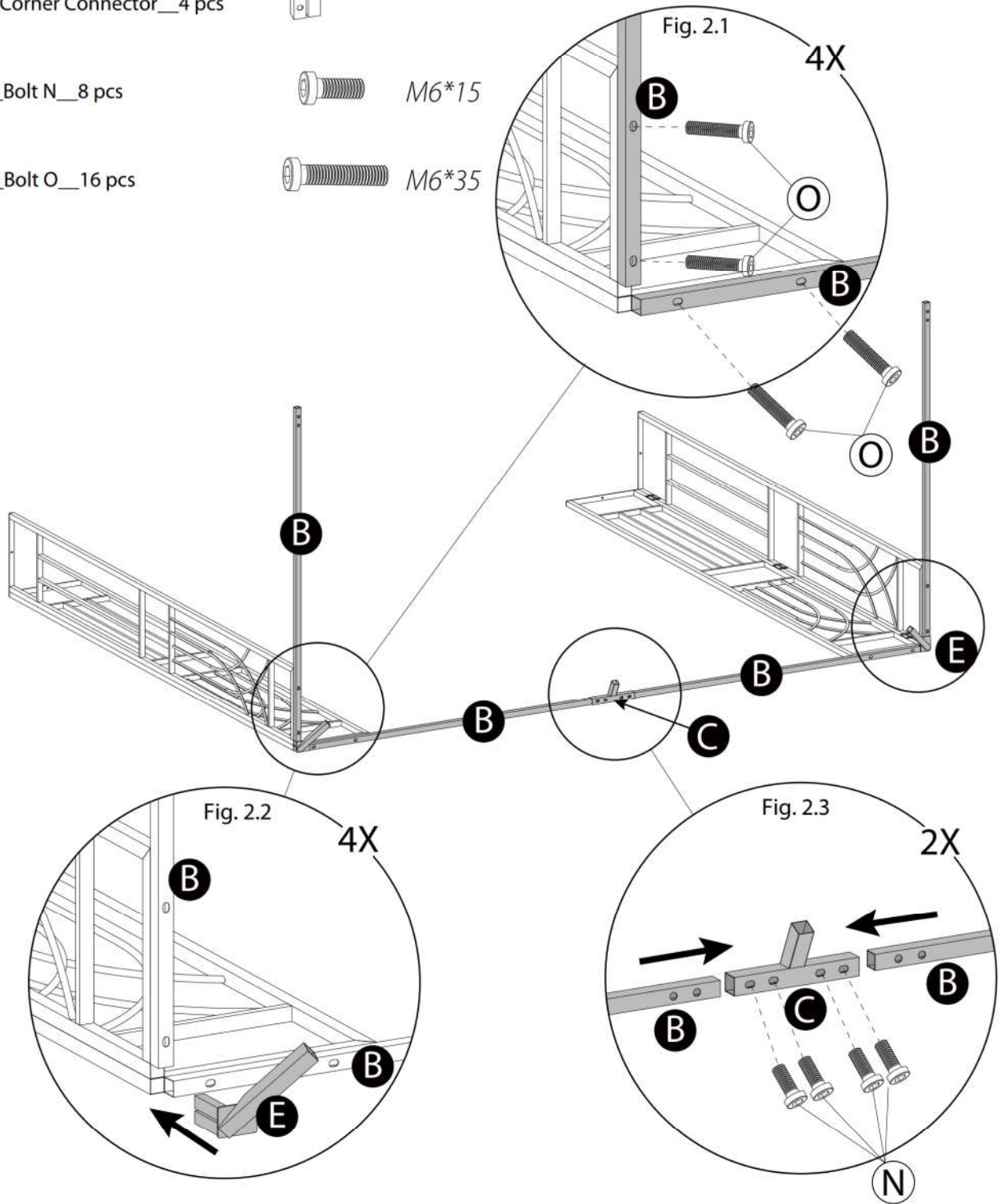

### Step 3

C\_Beam Connector\_\_2 pcs

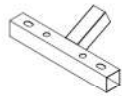

N\_Bolt N\_\_8 pcs



M6\*15

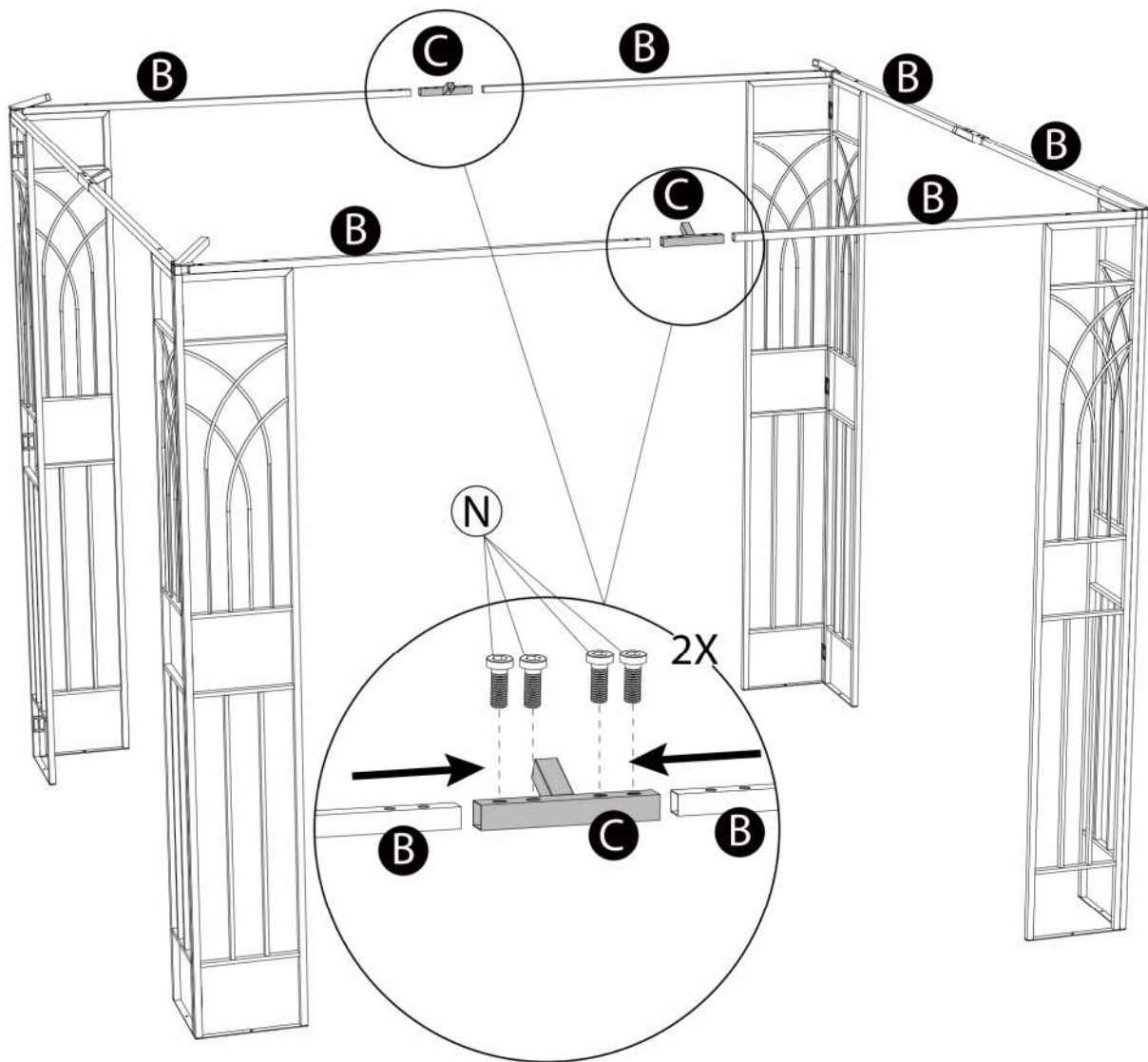

# Step 4

D\_Corner Ceiling\_4 pcs



G1\_Peak Connector\_1 pc

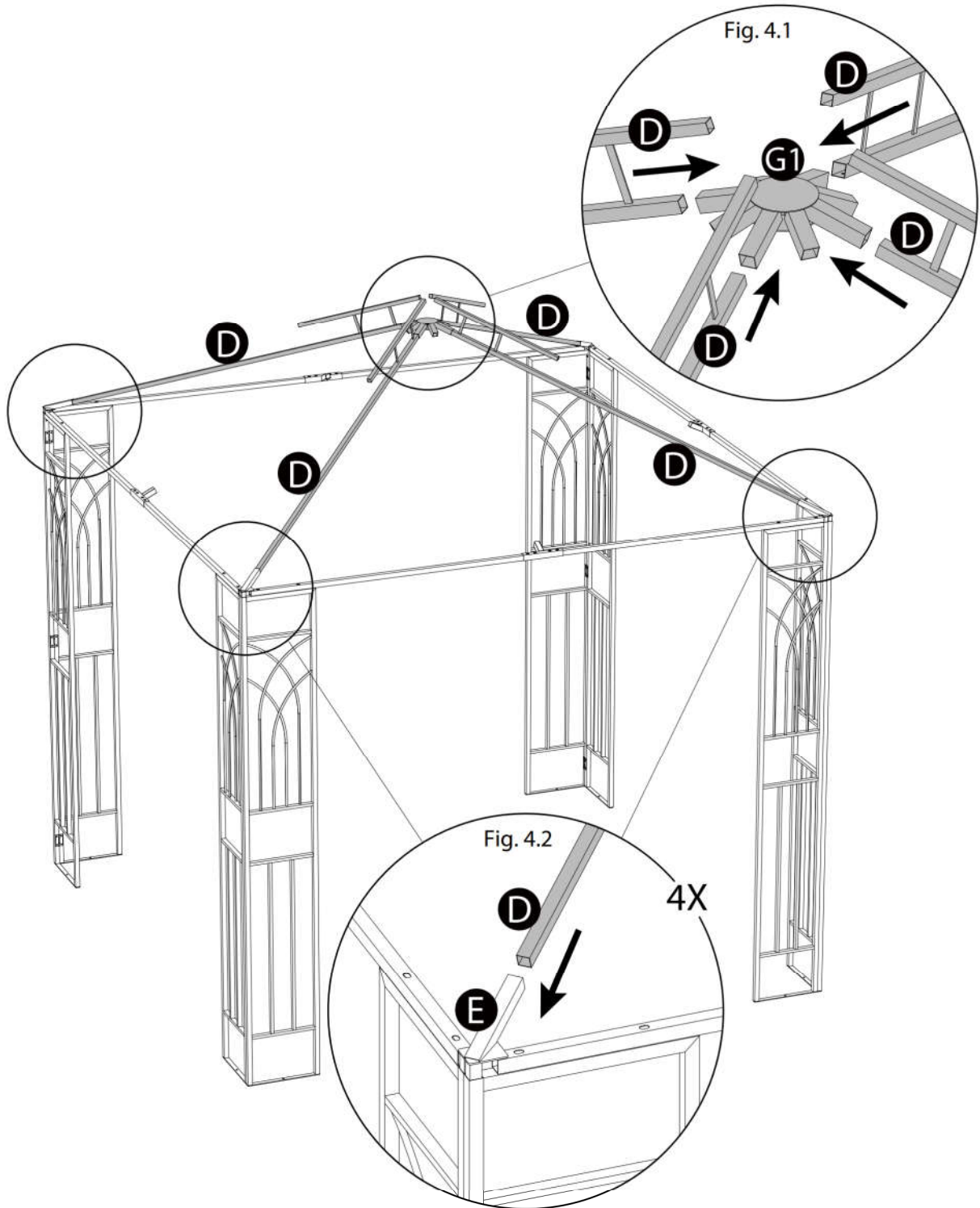
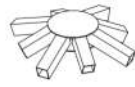

# Step 5

F\_Middle Ceiling\_4 pcs

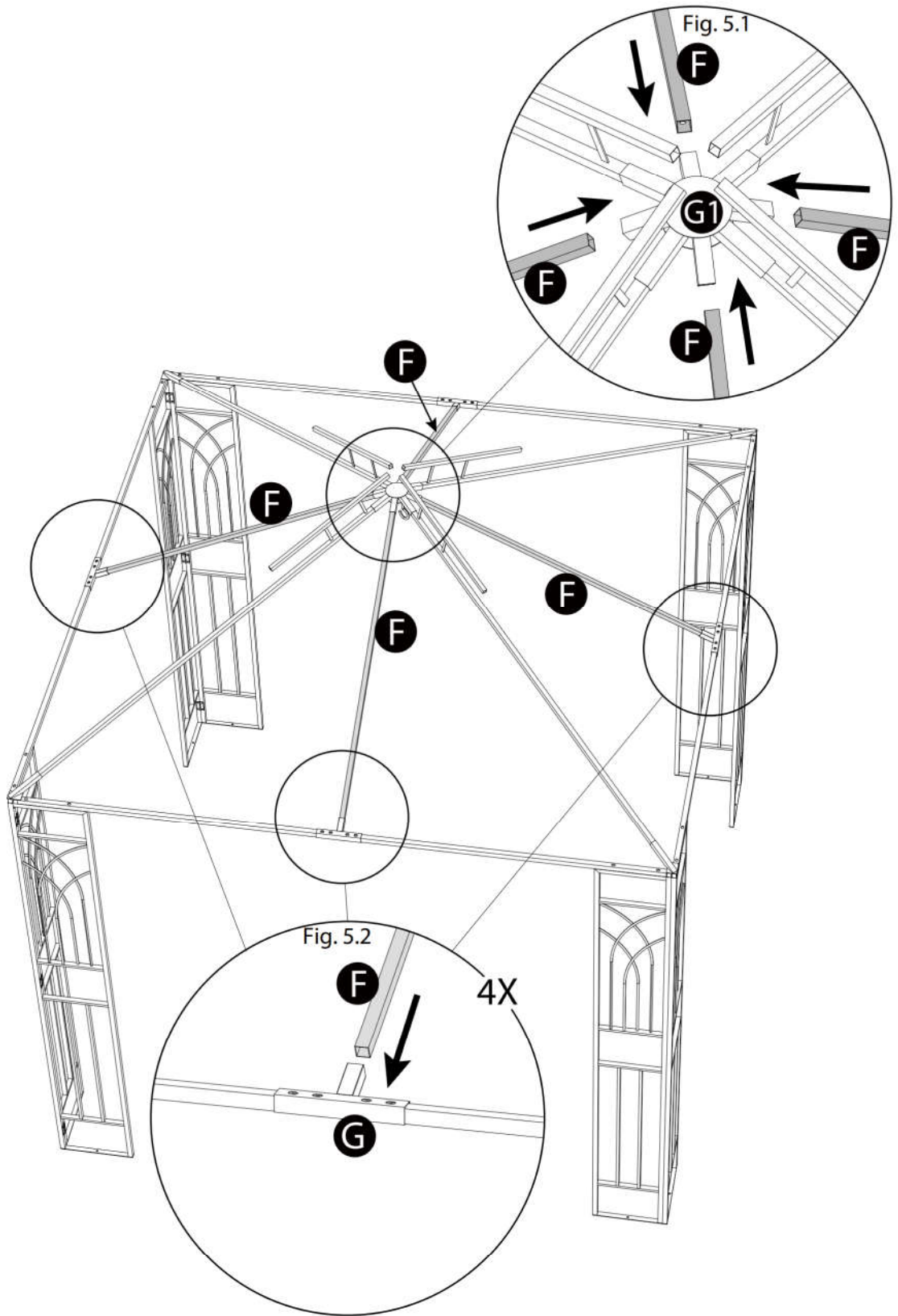

## Step 6

G\_Hook\_1 pc



H\_Corner Shelf\_4 pcs

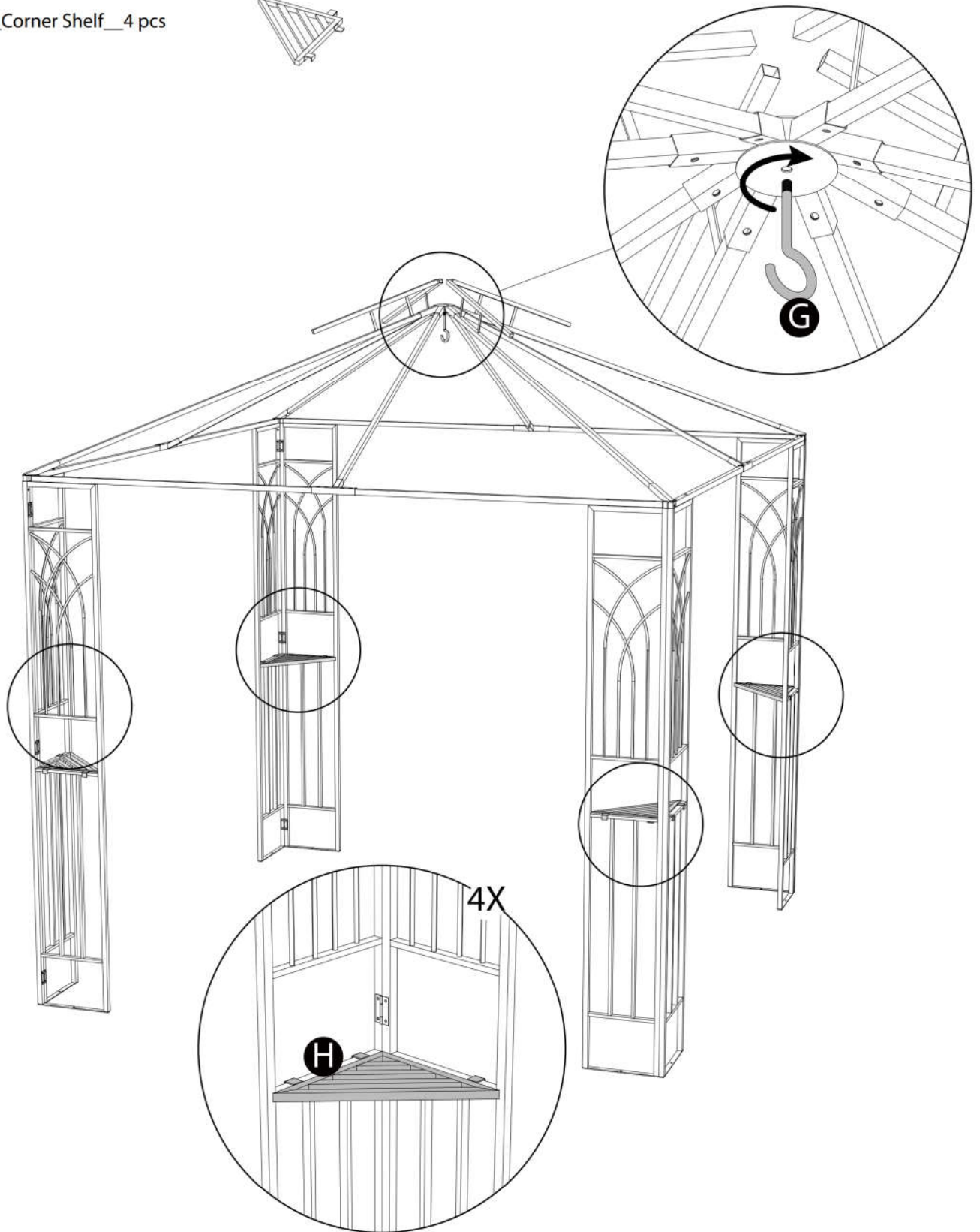

# Step 7

J\_Small Top Cover\_\_1 pc



K\_Big Top Cover\_\_1 pc

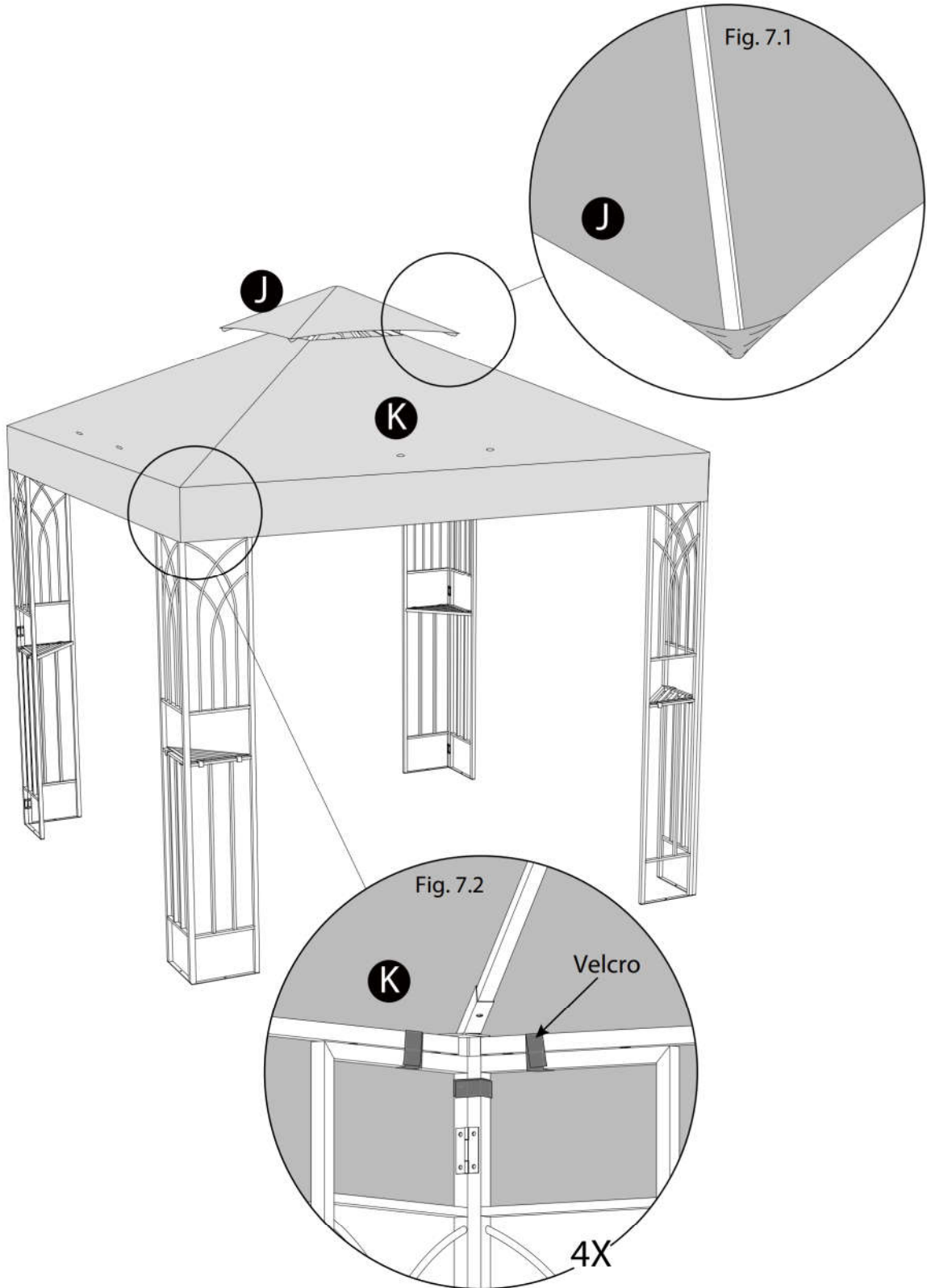

# Step 8

M\_Stake\_8 pcs

