

## WARNING

**\*\* WE RECOMMEND INSTALLATION OF THIS LIGHTING FIXTURE BE DONE BY A LICENSED ELECTRICIAN \*\***

- \* Switch off the main electrical supply from the main fuse box / circuit breaker before installation.
- \* Inspect item carefully before attempting to install.
- \* If there is any damages or obvious defects, do not install.
- \* Item may not be returned once it has been installed.























## CARE AND MAINTENANCE

- \* To clean the outside of the fixture, use a dry or slightly dampened clean cloth (use clean water, never a solvent) to wipe the surface of the fixture.
- \* To clean the inside of the fixture, first disconnect power to the fixture by turning off the circuit breaker or by removing the fuse at the fuse box. Next, use a dry or slightly dampened clean cloth (use clean water, never a solvent) to wipe the interior surface of the fixture.
- \* Do not use any cleaners with chemical, solvents or harsh abrasives. Use only a dry soft cloth to dust or wipe carefully.

## NOTICE& IMPORTANT SAFETY INSTRUCTIONS

- \* Please make sure that you have all parts indicated before you begin assembly of this item
- \* This item should be assembled on a soft surface to prevent scratching the finish during assembly
- \* To reduce the risk of fire, electrical shock or injury to persons or property, please follow the guideline below for safe use and installation
- \*The external flexible cable or cord of this lamp cannot be replaced  
If the cord is damaged, the lamp shall be destroyed

### Part List and Hardware List

PIECE	DESCRIPTION	PICTURE	QUANTITY	PIECE	DESCRIPTION	PICTURE	QUANTITY
A	Mounting Plate		1X	L	Swivel		2X
B	Green Ground screw		1X	M	6"Rod		4X
C	Outlet box screw		2X	N	12"Rod		4X
D	Anchor		4X	P	Fixture body		1X
E	Tapping screw		4X	Q	Light bulb		10X
F	Wire Nut		3X	R	Set screw		14X
G	Hex nut		2X	S	Banding metal Plate		14X
H	Teeth washer		2X	T	Crystal glass		14X
I	Metal Plate		1X	U	Spanner		1X
J	Canopy		1X	V	Spanner		1X
K	Canopy screw		4X	W	spare EVA Pad		5X

**Product Dimensions: 34.5"L X 14.5"W X 19"- 49"H**

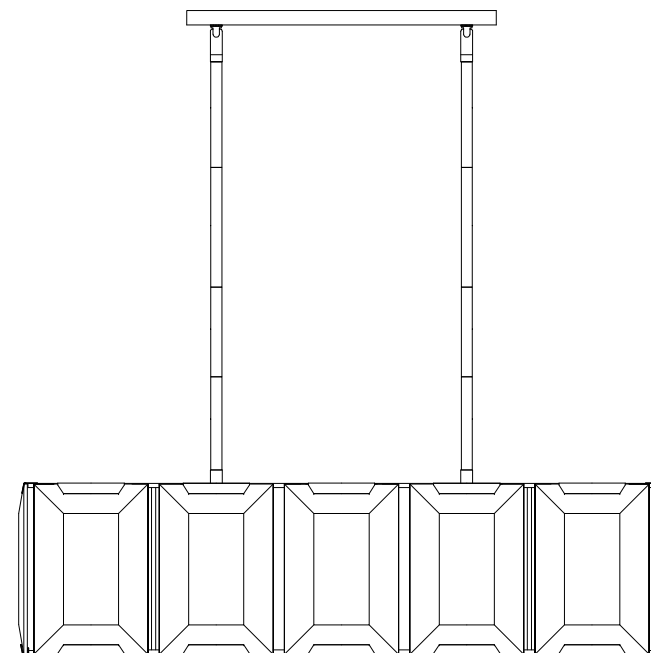

## PREPARATION

- \* Before beginning assembly of product, make sure all parts are present. Compare parts with package contents list and hardware contents list.
- \* If any part is missing or damaged, do not attempt to assemble the product.
- \* Estimated Assembly Time: 20 minutes.
- \* If you are having difficulty, our friendly Customer Care team is always here to help.

**NOTE:PLEASE USE TYPE"B" BULB MAX 25-WATT OR LED BULB MAX 5-WATT, THERE ARE 10PCS LED 4-WATT BULB IN THE BOX**

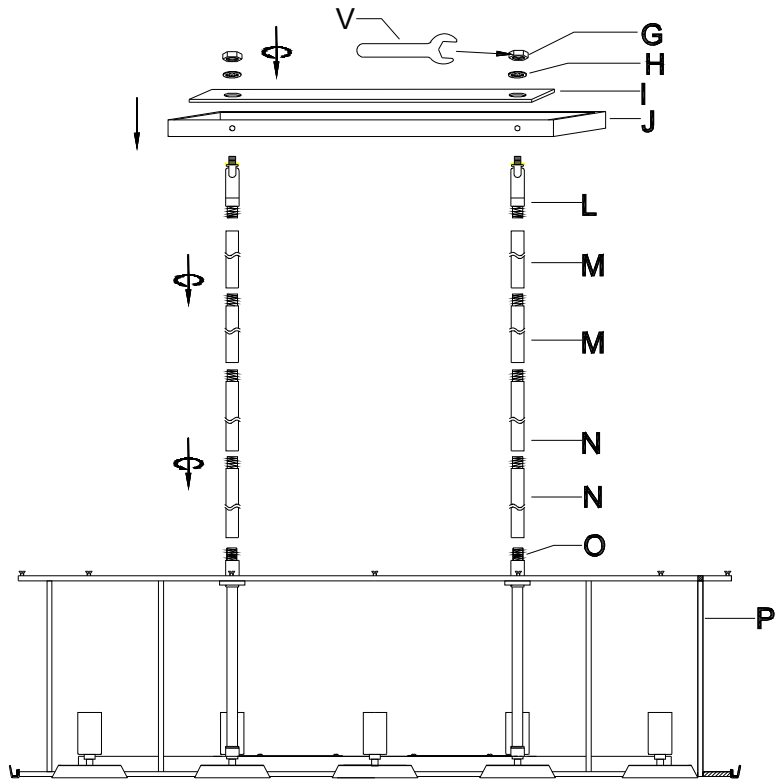

**Step 1:** Raise the 12" rod (N) and 6" rod (M) thread to the pipe thread (O), then attach the swivel (L) to the rod (M). Attach the canopy (J), metal plate (I) and teeth washer (H) to the swivel (L), secure with hex nut (G) by using the spanner (V).

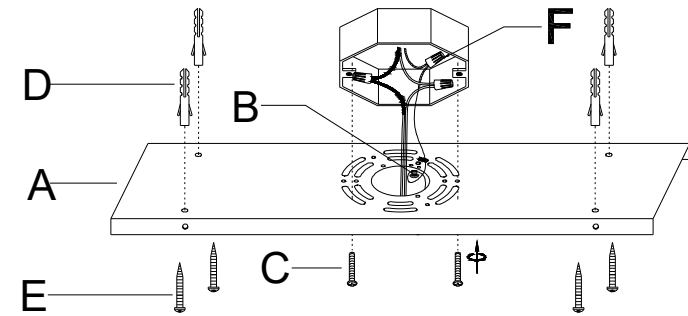

**Step 2:** Punching the hole and install the anchor (D) to the ceiling. Attach the mounting plate (A) to the junction box with outlet box screw (C), secure with tapping screw (E).

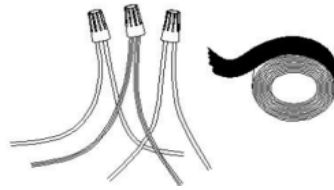
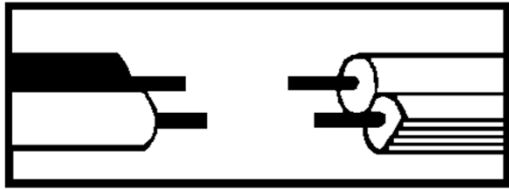

**Step 3: Wire connection**

Connect fixture neutral wire (ribbed) to the outlet box neutral wire (usually white) using a wire nut. Connect fixture hot wire (smooth with markings) to the outlet box hot wire (usually black) using a wire nut.

CAUTION: Do not reverse the hot and neutral connections

Grounding Instructions:

Wrap ground wire from outlet box around green ground screw(B) on mounting bracket, no less than 2" from wire end. Tighten ground screw. If fixture is supplied with a ground wire, connect to outlet ground wire with a wire connector.

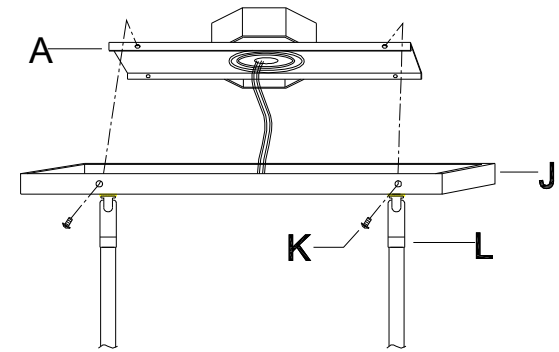

**Step 4:** Attach the canopy (J) to the mounting plate (A), secure with canopy screw (K).

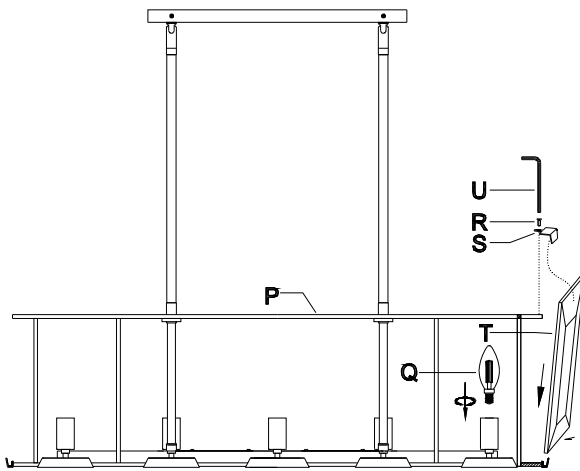

**W**

Tips: When assembling the crystal glass, you can attach the EVA pad (W) to the clips on the top and bottom to make the crystal glass more firm

**Step 5:** Install the crystal glass (T) to the groove or fixture body (P), fix with banding metal plate (S), finally secure with set screw (R).

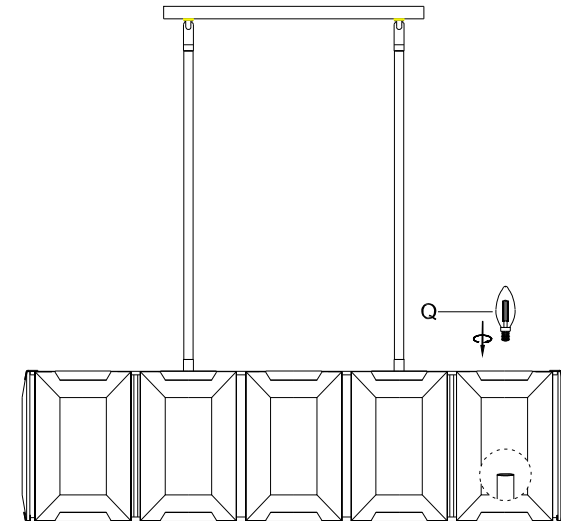

**Step 6:** Install the light bulb (Q) to the socket.