



ball end wrench making the assembly friendly

For any missing or damaging parts, hardware, or any other problems,
WELCOME to email us at:

SERVICE@RILYSON.COM









PRE-ASSEMBLY PREPARATION:





DO NOT LET CHILDREN PLAY IN OR AROUND THE UNIT DUE TO THE POSSIBLE RISK OF FINGER ENTRAPMENT.

- Please read through the instructions before beginning assembly.
- Clear out the space for assembly and lay out all of the parts based on the Parts List, extra room will allow you to easily determine if all the pieces are present.
- Save all packing materials until assembly is complete to avoid accidentally discarding smaller parts or hardware.
- Keep small parts and pieces away from children until fully assembled.
- Ensure that all bolts are securely tightened before use. It is recommended that you re-check all nuts and bolts
- Use on even surfaces only.
- Improper use of this product or failure to use as directed may result in injury.

PANEL AND FITTINGS IDENTIFICATION:

 <p>Left Arm (A1) Qty:1</p>	 <p>Right Arm (A2) Qty:1</p>	 <p>Chair Back (B) Qty:1</p>
 <p>Seat Panel (C) Qty:1</p>	 <p>U-shaped Fitting (D) Qty:1</p>	 <p>Chair Base (E) Qty:1</p>
 <p>Seat Cushion (M) Qty:1</p>	 <p>Back Cushion (N) Qty:1</p>	

HARDWARE LIST:

 <p>Spring Washer (F) Qty: 4</p>	 <p>Washer (G) Qty: 18</p>	 <p>Nut (H) Qty: 8</p>	 <p>Short bolt (I) Qty: 4</p>
			

Long Bot (J)
Qty: 14

Allen Wrench (K)
Qty: 1

Open End Wrench (L)
Qty: 1

STEP-BY-STEP ASSEMBLY:

1

Step 1: Secure chair back (B) to left arm (A1) with 2 bolts (I) and 2 washers (G) by using allen wrench (K). Do not tighten all bolts now



2

Step 2: Secure right arm (A2) to assembled chair back (B) with 2 bolts (I) and 2 washers (G) by using allen wrench (K). Do not tighten all bolts now.

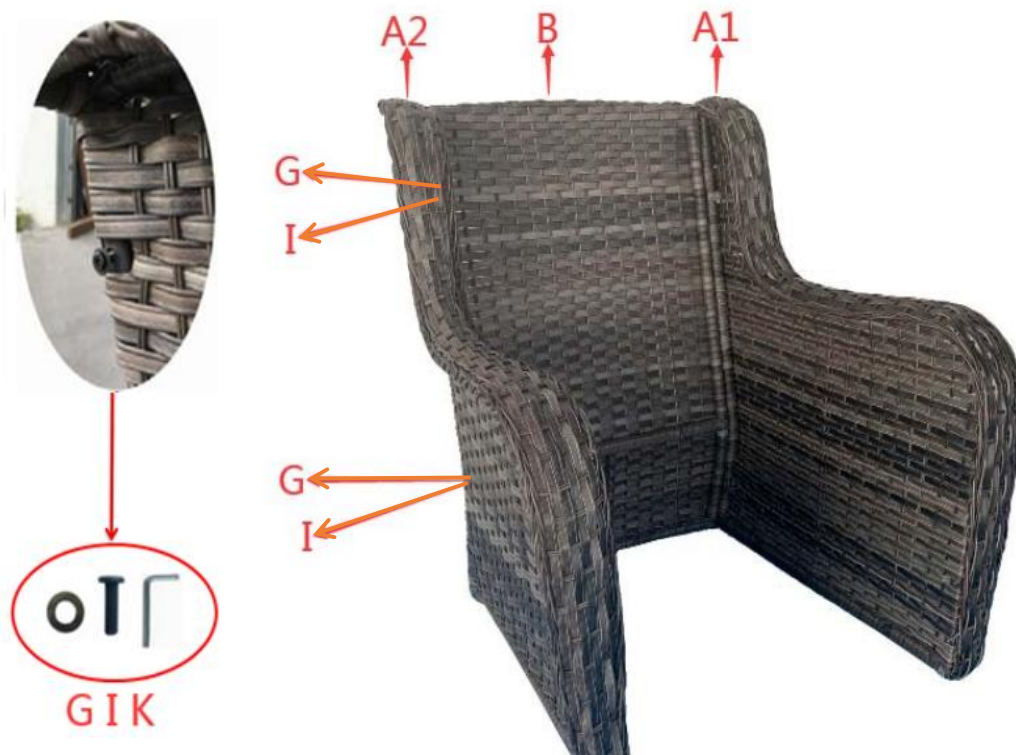



3

Step 3: Secure seat panel (C) to assembled left arm and right arm (A1.A2) with 4 bolts (J) and 4 washers (G) by using allen wrench (K). Do not fully tighten now.

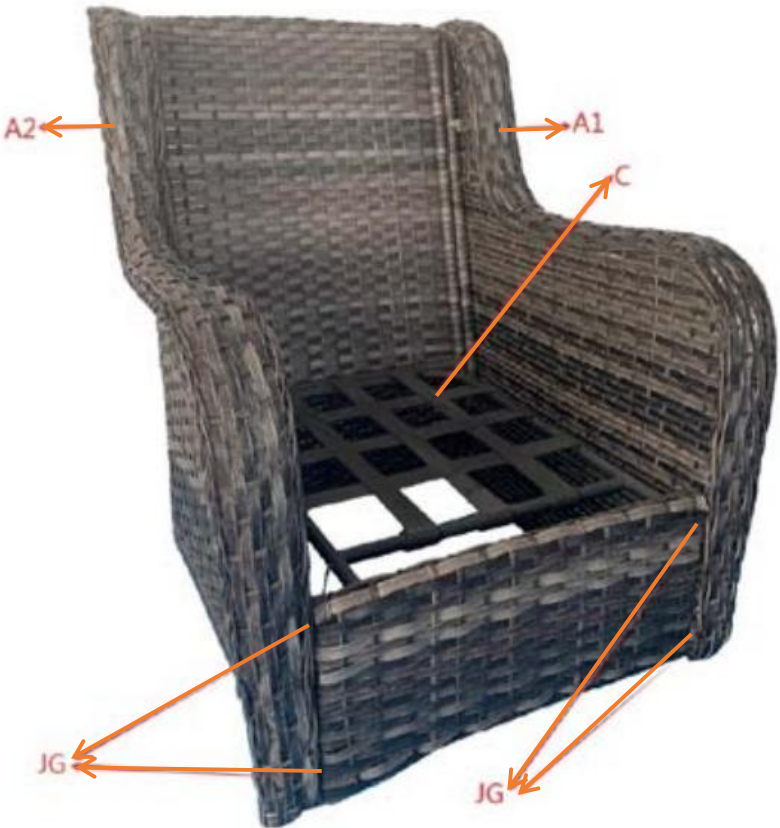

4

Step 4: Secure seat panel (C) to assembled chair back (B) with 2 bolts (J) and 2 washers (G) by using allen wrench (K), verify the alignment and adjust, fully tighten all the bolts now.

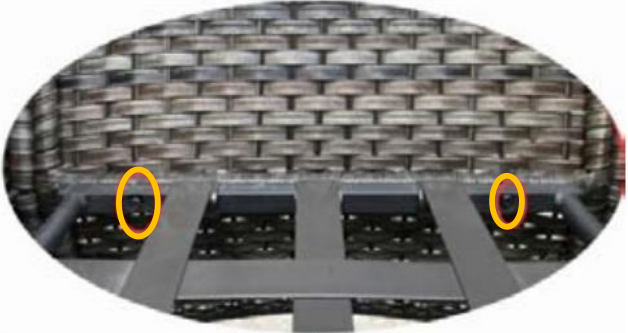

5

Step 5: Turn over the assembled chair bucket and secure the swing arms on U-shaped fitting (D) to the bottom tube of left arm (A1) and right arm (A2) with 4 bolts (J), and 4 nuts (H) with allen wrench (K) and wrench (L).

NOTE: PLEASE FIX TWO bolts IN DIAGONAL POSITION TO KEEP THE BALANCE THEN FIX THE OTHER TWO bolts.

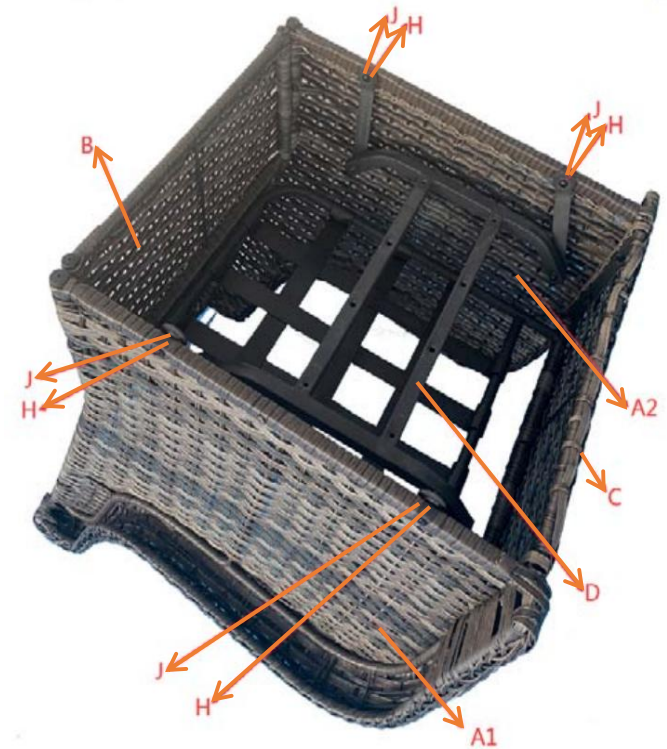

6

Push the top plate on the base (E) with different position to make the holes open for ready assembling. Connect the 4 bolts (J) through the holes of the plate on the base (E) and the holes on the tube of U-shaped fitting (D) with 8 washers (G), 4 spring washers (F) and 4 Nuts (H) by using allen wrench (K) and open end wrench (L). NOTE: THIS STEP IS VERY IMPORTANT. DO READ THE INSTRUCTION AND DIAGRAM CAREFULLY.

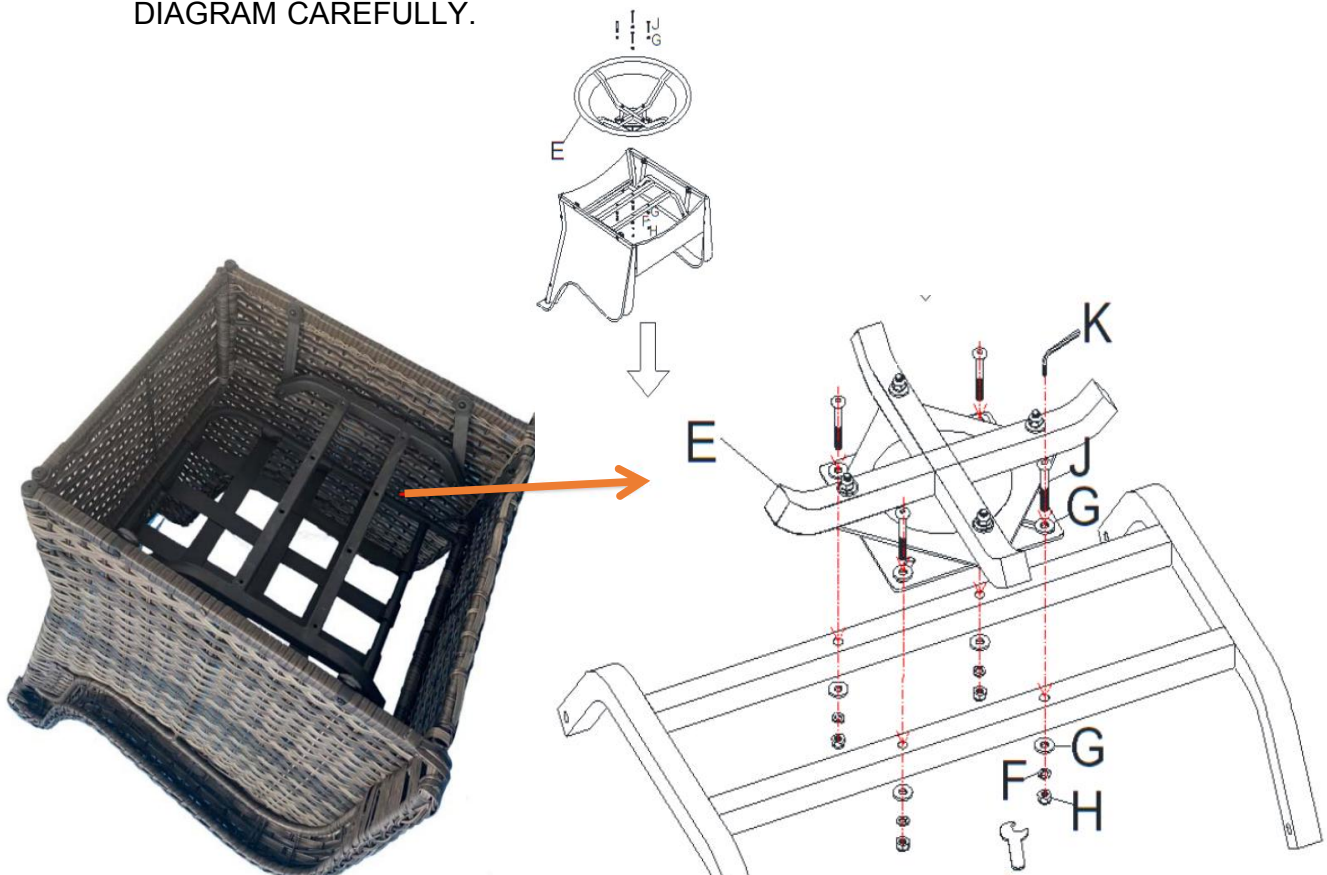

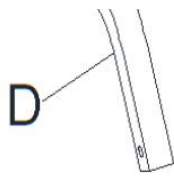

L

7

Step 7: Put seat cushion (M) and back cushion (N) on the chair. The chair is assembled.



SPECIAL WARNING:

THIS CHAIR IS NOT A TOY. DON'T OVER-SWING THE CHAIR. OVER-SWING THE CHAIR MAYBE MAKE THE CHAIR TIP OVER AND RESULT IN INJURY. DO NOT STAND ON THE CHAIR. Any improper use of this product may result in injury.



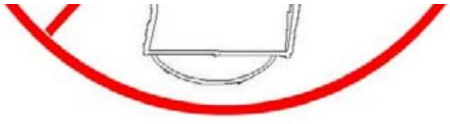

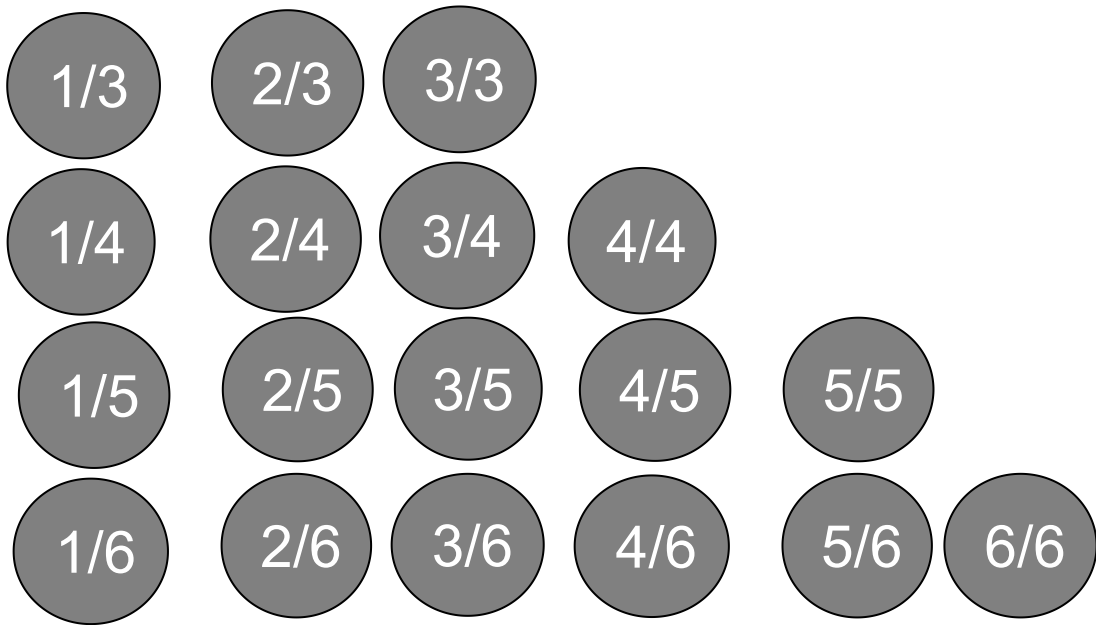

A B C D E F G
H I J K H M N
O P Q R S T



