

ASSEMBLY INSTRUCTIONS

TOOLS REQUIRED:

Allen key (supplied, part # E)

BEFORE YOU START:

1. Check the parts against the parts list to make sure all items are present.
2. Assemble your furniture on a soft, flat surface to avoid scratching the finish.
3. **CAUTION:** Do not over tighten screws, nuts or bolts during assembly.
4. Your furniture may require occasional tightening.

INSTRUCTIONS:

1. Attach the base to the post, using Bolt (B), Lock Washers (D) and Flat Washers (C). Tighten with Allen key (E). (See Figure 1).
2. Place the table surface upside down on a flat, soft surface. Attach the Mounting plate to the base, using Bolt (A), Lock Washers (D) and Flat Washers (C). Tighten with Allen key (E). (see Figure 2).

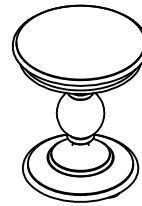

011-916

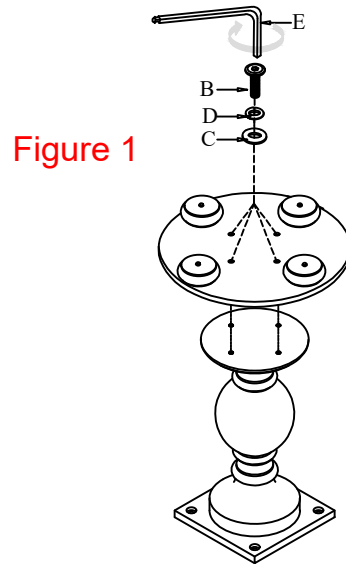

Figure 1

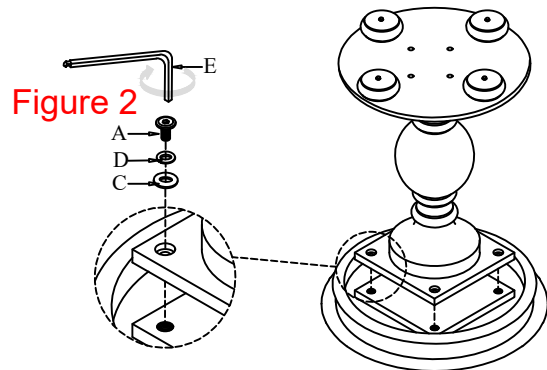
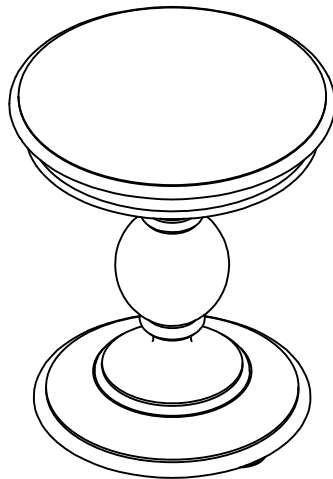





Figure 2

No.		Hardware List	Q'ty
A		Bolt Ø5/16" x L1-1/4"	4
B		Bolt Ø5/16" x L2"	4
C		Flat Washer Ø5/16"	8
D		Lock Washer Ø5/16"	8
E		Allen Key 4mm	1