

# Assembly Instructions

Caution : You must read this before you proceed

## CHAIR

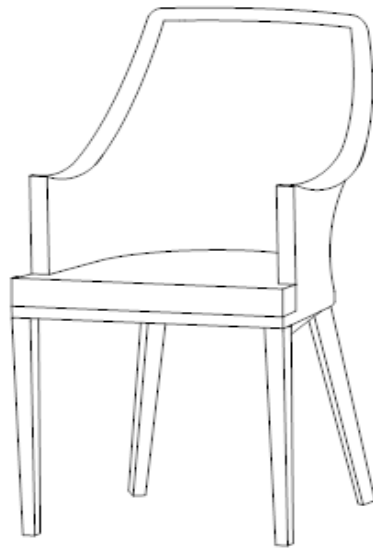



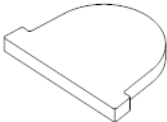

### Part List

Label	Picture	Description	QTY
A	A line drawing of the seat part of the chair, showing its curved shape and the attachment points for the legs.	Seat	1
B	A line drawing of the right leg part of the chair, showing its curved shape and the attachment points for the seat and the other leg.	Right Leg	1
C	A line drawing of the left leg part of the chair, showing its curved shape and the attachment points for the seat and the other leg.	Left Leg	1

D		Seat Cushion	1
---	---	--------------	---

## Hardware

Label	Picture	Description	QTY
①		Bolt (M6*30MM)	5
②		Bolt (M6*20MM)	5
③		Washer	10
④		Allen Key	1

## Assembly Preparation

Before Beginning Assembly:

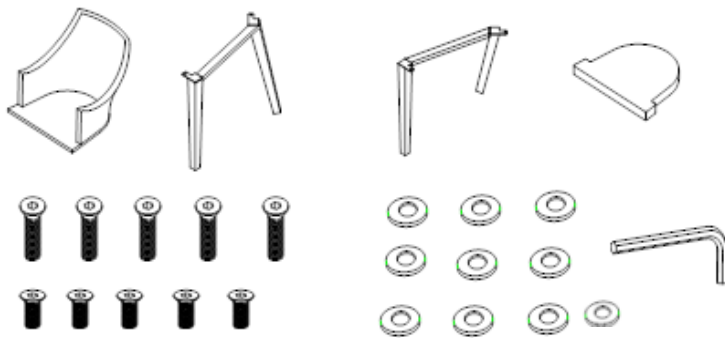

- Read instructions, cover to cover-



- Have 2 adults on hand for assembly-



- Do not assemble on flooring or carpet-



- Assemble on a clean non-marring surface (packing foam)-



- Save all packaging until finished-

# Assembly Steps

## Overview

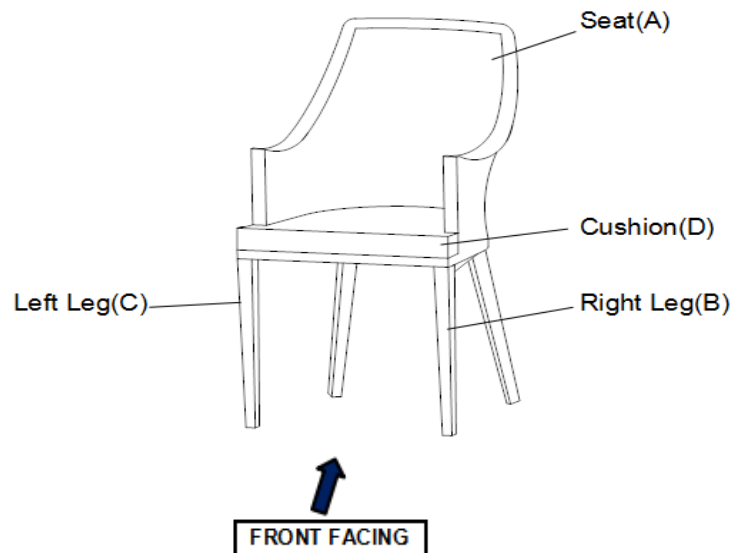

This Chair has multiple parts and may require up to **30** minutes to assemble. To give you an overview of the Chair parts, the above picture is to help you put the various parts into perspective. Please read through the instructions below to familiarise yourself with the parts and steps before assembly.

## Step 1

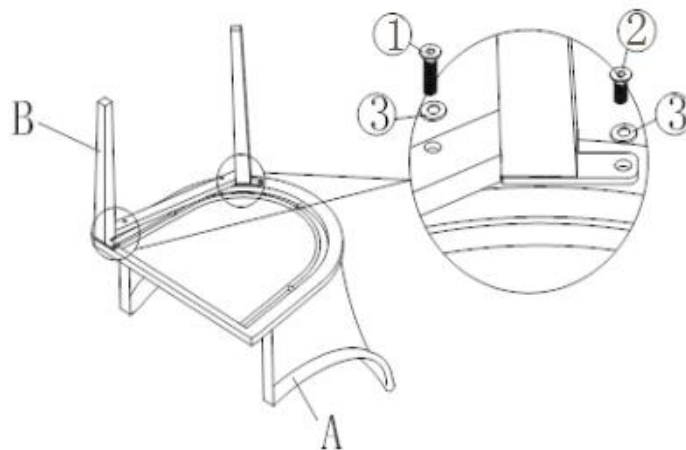

Open the carton and place all the parts onto a clean, non-marring surface.

Attach the Right Leg(B) to Seat(A) using Bolts(①) and Washers(③) with Allen Key(④) as shown above.

Attach the Right Leg(B) to Seat(A) using Bolts(②) and Washers(③) with Allen Key(④) as pictured.

**Do not fully tighten the Bolts.**

**Occasionally some of the PE Wicker shifts and covers the mounting positions preventing easy assembly. The PE Wicker should never be cut, but moved away from the mounting positions.**

## Step 2

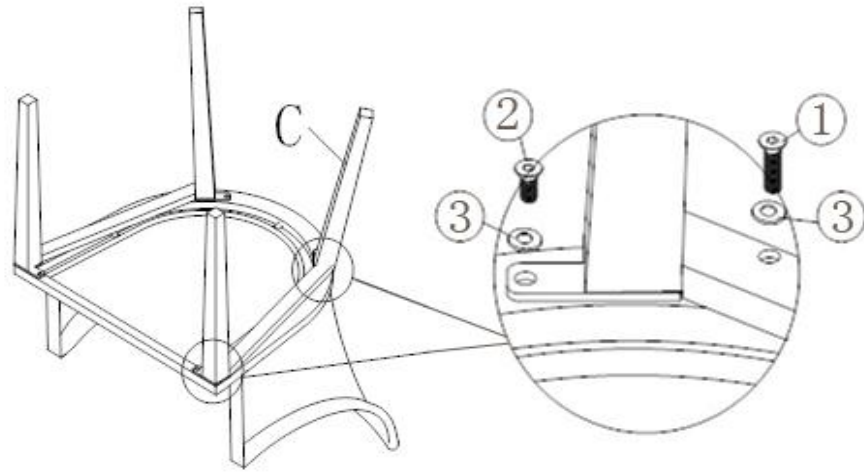

Attach the Left Leg(C) to Seat(A) using Bolts(①) and Washers(③) with Allen Key(④) as shown above.

Attach the Left Leg(C) to Seat(A) using Bolts(②) and Washers(③) with Allen Key(④) as pictured.

**Tighten all Bolts at all joints in a sequential manner.**

**Occasionally some of the PE Wicker shifts and covers the mounting positions preventing easy assembly. The PE Wicker should never be cut, but moved away from the mounting positions.**

## Step 3

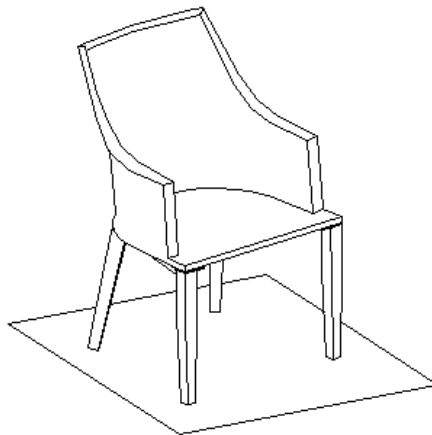

Stand the Chair up.

Place the Chair on a level surface to check for wobbles.

If the Chair wobbles, adjust the Levelers on the bottom of the Legs to make it level.



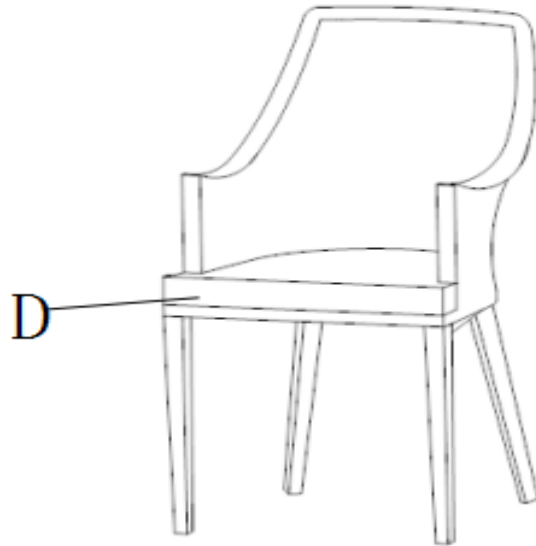

















## Step 4



Put the Seat Cushion(D) on the Chair.  
Your Chair is ready for use.

**This Chair can only be used on the flat and level surface.**

## Care & Maintenance

-   ● Do not put hot items directly on furniture surface
  -   ● Do not clean furniture with harsh cleansers or polish.
  -   ● To obtain the longest lifespan of your outdoor products, minimizing exposure to direct sunlight is recommended.
  -   ● Children should not climb or jump on the furniture.
  -   ● Do not write on furniture without a padded barrier to protect the surface.
  -   ● To obtain the longest lifespan of your outdoor products, avoid extended and lengthy exposure to rain, snow, and direct sunshine. Whenever possible cover the product and /or place under patio or awnings.
  -   ● Not for commercial use. For residential use only .
  -   ● Stains may be removed with mild soap solution and damp cloth.
  -   ● Keep away from sources of ignition.
- 
-   ● Dust and pick-up spills using a clean, non-colored, lint-free cloth.