

Thank you for Shopping with us!

We hope we were able to provide your home with the perfect vanity. This vanity has been constructed with design, quality and functionality in mind. We hope you enjoy this new addition!

Your feedback is invaluable to us and we would love to hear about your experience. Please take the time to leave us a review.

We encourage you to take a few minutes to go through this booklet. It contains important information on installation and care tips to keep your furniture looking as good as new.

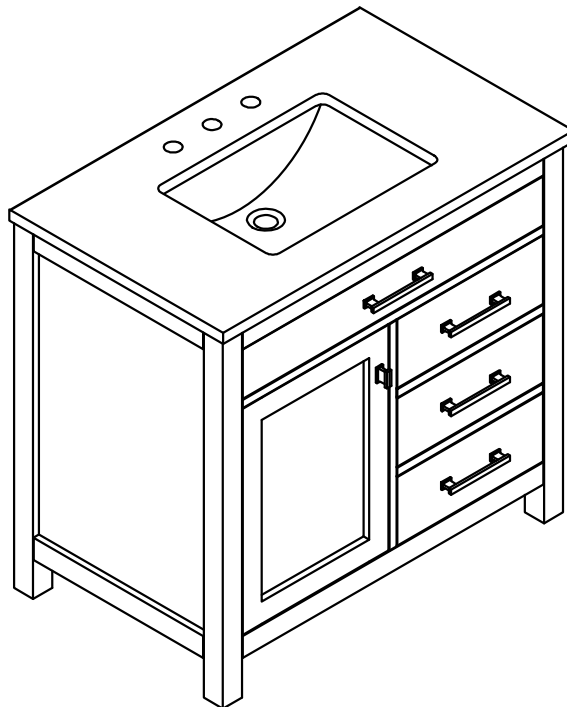

36" Bathroom Vanity

Before installation, please check and ensure you received the items in the below "Part List". Please report any missing items to your retailer immediately.

Part List

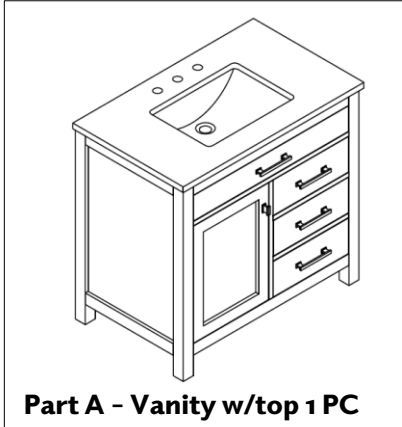

NOTES, ASSEMBLY AND INSTALLATION

- **Faucet, Drain, Silicone and all other plumbing components, tools & hardware are not included.**
- **Handling will require two people.**
- **Ensure the vanity is installed on a level floor. Unevenness can cause the vanity to become misaligned, resulting in twisting of the cabinet. Repair any uneven areas with adjustable foot levelers.**
- **Adjust shelves as needed to accommodate plumbing.**
- **Ensure all building & plumbing codes are respected. Professional installation recommended.**

STEP 1

- **Place the vanity in the desired location.**
- **Ensure the vanity is level by using the adjustable foot levelers.**
- **Install the faucet and all plumbing.**
- **Ensure there are no water leaks.**

36" Bathroom Vanity

Instructions for adjusting hinges

You may need to adjust the hinges to align the doors and obtain consistent spacing between the doors, as floors are not all level and hinges may shift during transport.

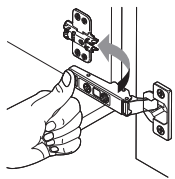

install

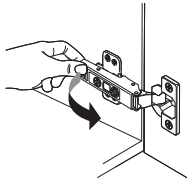

remove

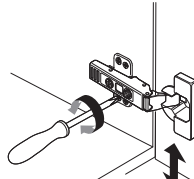

adjust height

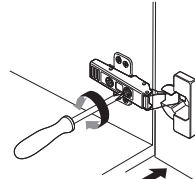

adjust laterally

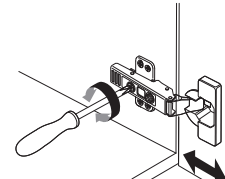

adjust depth

36" Bathroom Vanity

Instructions to remove the drawers

The drawer can be removed, if ever required. Locate the clips on both sides of the bottom of the drawer, press the clips and pull the drawer out. To reinsert, simply align the two sides of the drawer glides and slide it until inserted.

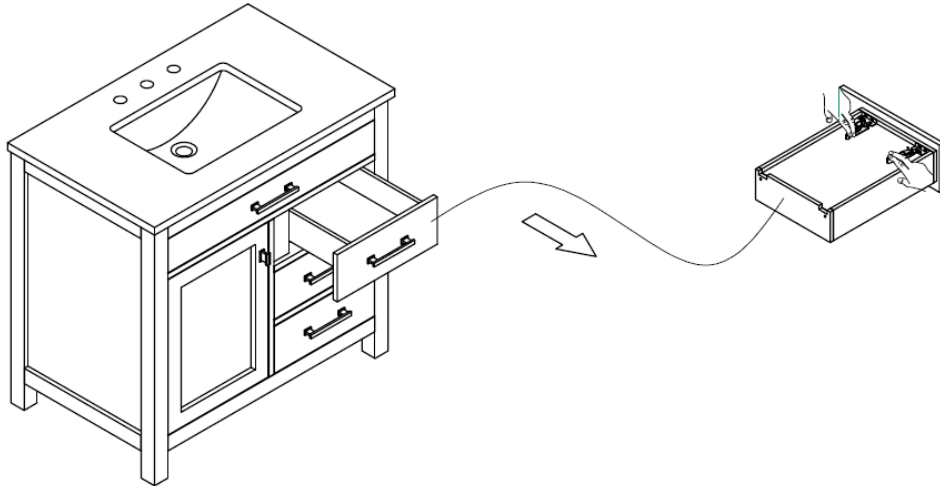

Once the drawer has been inserted, check to ensure that the drawer moves with ease. If it does not, this would most likely be due to an alignment issue, which can be easily resolved by leveling the drawers. Drawer can be leveled by sliding the small adjustment knob forward or backward. This can raise or lower the drawer.

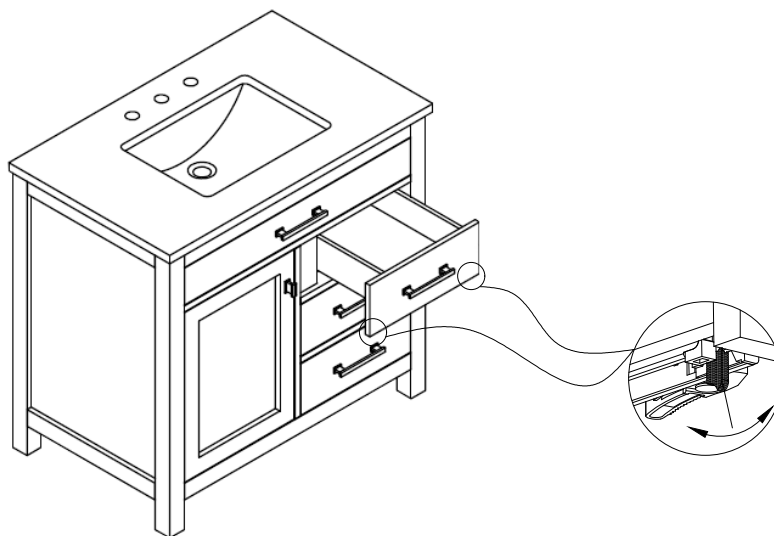

36" Bathroom Vanity

CARE, CLEANING AND MAINTENANCE

- **Dust regularly with a soft, dry cloth.**
- **Avoid the use of all chemicals, household cleaners and abrasives that may damage the finish.**
- **Excessive exposure to sunlight and extreme changes in temperature and moisture can damage wood furniture.**
- **Quartz is a durable non-porous material that resists stains, and with minimal maintenance can last a long time**
- **For daily cleaning, use warm water and a non-abrasive cloth or paper towel to wipe the surface, then dry it with a soft cloth. Or use a mild soap, but steer clear of cleaners with bleach or abrasives. After washing, rinse well and dry with a soft cloth.**
- **Avoid placing hot appliances, such as curling irons and hot hair dryers directly on the countertop.**
- **Avoid placing extremely heavy items on the quartz top to prevent chipping or cracking.**
- **Avoid spilling products onto the quartz surface that contain oils or are petroleum-based, or are acidic or caustic such as vinegar, citrus, sodas, chlorine or nail polish remover.**
- **All spills should be removed immediately to prevent staining. Prolonged exposure to certain substances can cause discoloration.**
- **We recommend sealing the countertop with a quality stone sealer each year to prevent discoloration and stains.**
- **Larger scratches, chips, and resilient stains may require professional help. Please contact your local stonemason for details.**

36" Bathroom Vanity

DIMENSIONS

TOP VIEW

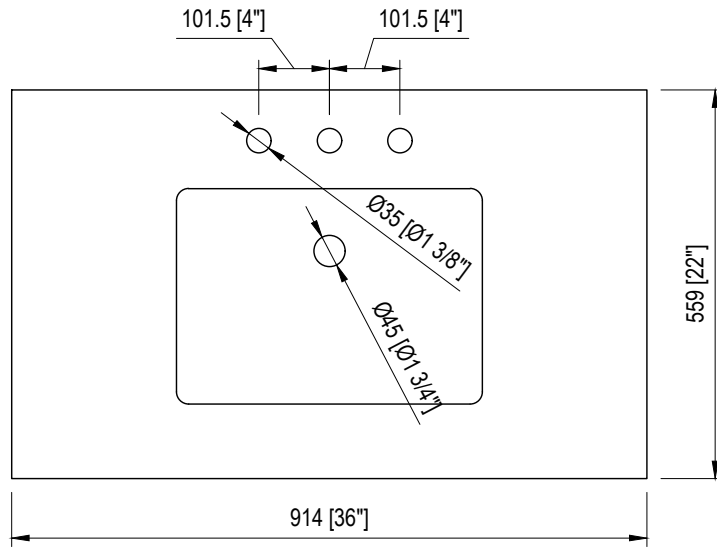

BACK VIEW

