ATTENTIONS

1. Use this product only for seating one person at a time
2. Do not stand on the chair use as a step stool or ladder
3. Do not use the chair unless all bolts, screws and knobs are tighten
4. Do not place the product near the fire or heat source !
5. Do not use corrosive cleaners for cleaning !
6. This product is not a climbing frame for children's play,which could result in injury.Please do not leave children unattended

OFFICE CHAIR ASSEMBLY INSTRUCTION



Hello Friend,
Thank you for choosing our office chair



We strive to ensure proper delivery and satisfaction.
If you need any assistance, please contact us to get promptly support.

Our chair comes with product warranty service.
If you have any issues, please contact our after-sales service team immediately, we will provide you with satisfactory assistance and solution within 24 hours.

Please feel free to contact us via the following path:
Contact us via Amazon

Login your Amazon Account
"Your Order" > find the order ID > click "Contact Seller"

We appreciate and love our customers, if you need us, we will always be here.
Thanks again for your support and understanding!

Damaged or Missing Component
Promptly re-send component from amazon

Quality Problem
1. Promptly re-send product from amazon
OR
2. Order Refund



! NOTE

Note: When lowering down the seat height, please make sure to fully sit on the seat (as the right figure shows below) in order to give it enough pressure.

UK	REP
----	-----

Name: Sea&Mew Accounting Ltd
Address: Electric Avenue Vision
25, London, Enfield EN3 7GD
Contact Person: BillyHan
E-mail: info@seamew.net
Tel: +44 7399648608



Filling material(s) and covering fabric(s) meet the requirements for resistance to cigarette and match ignition in the Furniture and Furnishings(Fire)(Safety) Regulations 1988

**CARELESSNESS
CAUSES FIRE**

Q&A

Q: Where can I get installation instructions or videos?

A: There are installation videos in our product page for your reference to assist you in completing the installation smoothly. You can also contact us if you need electronic instruction document or further assistance.

Q: Can I complete the installation independently?

A: If you need to install the chair independently, we recommend that you to put the seat cushion on a higher table or chair to assist your installation. please refer to our installation video

Q: How can I adjust the tightness of the armrest?

A: There is built-in screw in the armrest connection. If needed, you can control the tightness of the armrest by adjusting the screw before installation .

Q: If the screws are not aligned with the holes during installation, how can I adjust them?

A: You can put the screws into the corresponding holes first, tighten them halfway. And then fully tighten all the screws after all the screws are set.

Q: What should I do if the package lacks of some components?

A: Please feel free to contact us for promptly help if the package lacks of some components.

Q: What should I do if my package were damaged?

A: Long-distance transit may cause damage to the item under special circumstances, please feel free to contact us for promptly help.

Q: How to adjust the lumbar support?

A: The height of the lumbar support can be adjusted by pushing the plastic slider up and down. (Please keep your back away from the backrest for smooth adjusting of the slider.)

Q: How to adjust if the chair is tilted forward?

A: It may be due to the wrong orientation of the tray and the seat cushion, please keep the tray and the seat cushion in the same direction as indicated.

Thanks for your support!

If you need further assistance, please feel free to contact our customer service team for prompt help, we will do our best to help you.

IMPORTANT

Please follow the instruction manuals and use a pad to avoid damage during assembly.

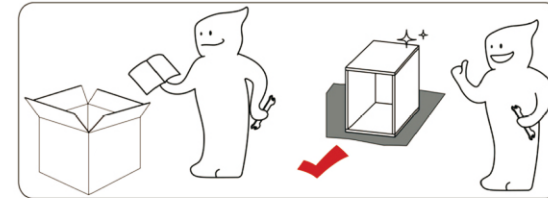
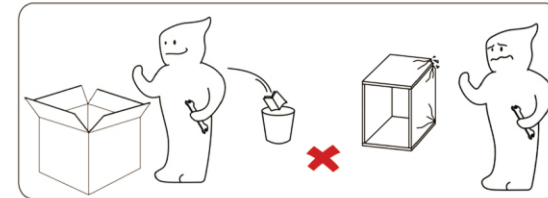

For easier and better assembly, **1** or more adults are required.



The expected assembly time for this product is **0.5 h**, depending on the individual's manipulative ability.



Not intended for use by children. Please keep your children closely supervised.



Keep away from fire or other heat sources.



Do not use harsh cleaner for cleaning!



We recommend wearing protective gloves for assembly.













Identify, sort and count the parts before assembly.

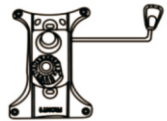
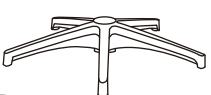
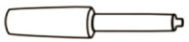

The warning, cautions and instructions listed in this manual may not cover all possible situations that may arise when using the product.

Please Make sure all parts are included

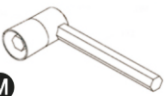
			
Backrest - 1pcs	Seat Cushion - 1pcs	Left Armrest - 1pcs	Right Armrest - 1pcs
			
Tray - 1pcs	Base - 1pcs	Gas Lift - 1pcs	Wheel - 5pcs
			
Wrench - 1pcs	Screw (M6*22) - 8pcs	Screw (M6*45) - 4pcs	Washer - 8pcs
			
Wrench for Armrest - 1pcs			



Notice: Before installation, please classify the screw, measure the screw length for easy assemble
(Each screw comes with 1 backup)

Setup Method

Tips 1: Height Adjustment

press the lever
to adjust the seat height
up and down

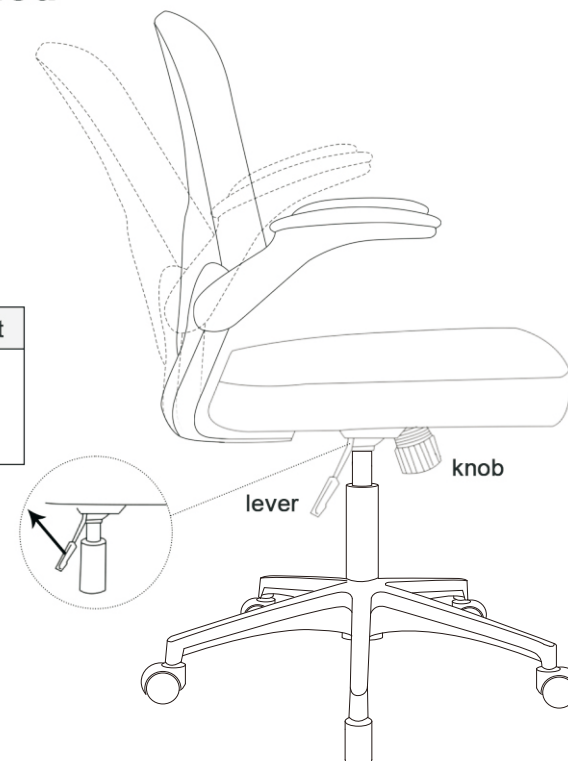

Tips 2: Tilt Tension Adjustment

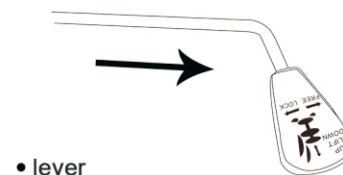

• lever

Step 1
pull out the lever to active
the rocking mode

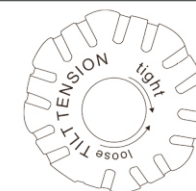

• knob

Step2
twist the knob to control
the tilt tension

STEP 7



For better using experience, After all the screws are set, please twist one more time to fully tighten them

Multiple Functions

Adjustable Lumbar

Pushing the slider to adjust the lumbar support (keep your back away from the backrest for smooth adjusting of the slider.)

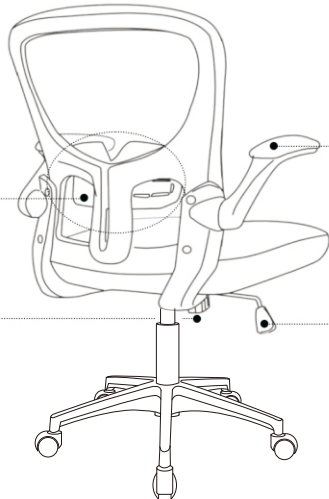

Flip-up Armrest

Armrest can be rotated up and down

Backrest Tilt

Backrest tilt tension adjustment
+Tighten-Loosen

Adjustable Height

Rotate the handle to adjust the height and the backrest tilt



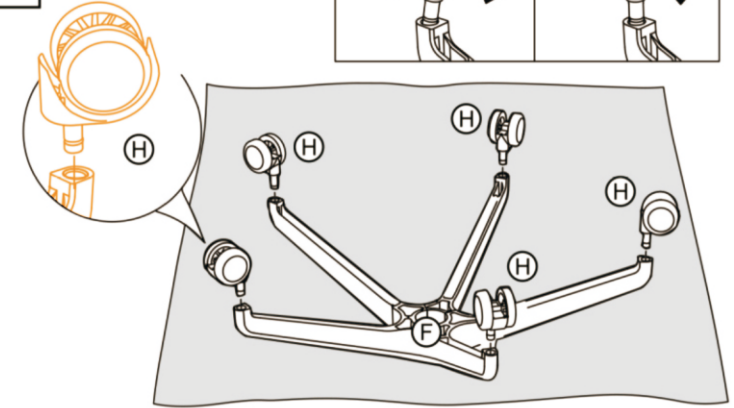
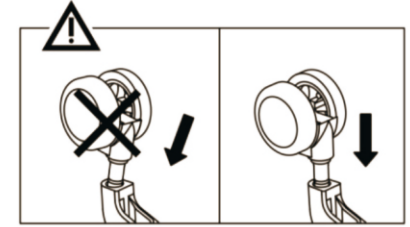
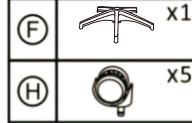

STEP 1

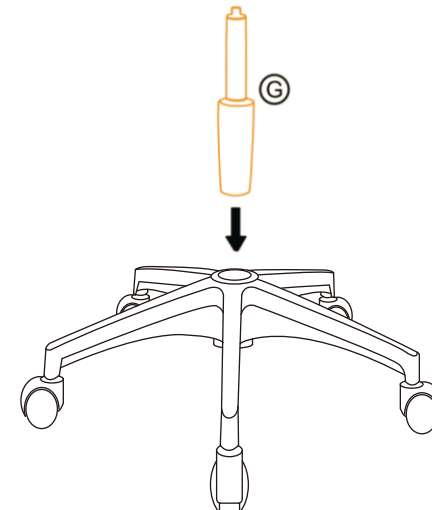

STEP 2



STEP 3

(A)		x1
(C)		x1
(D)		x1
(J)		x4
(M)		

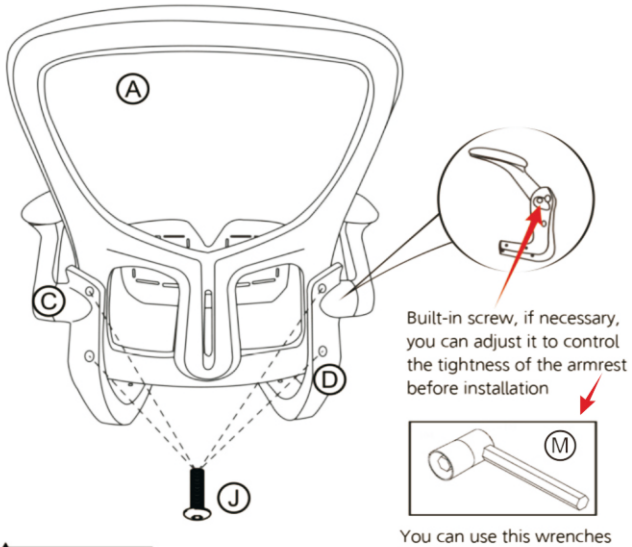

NOTE

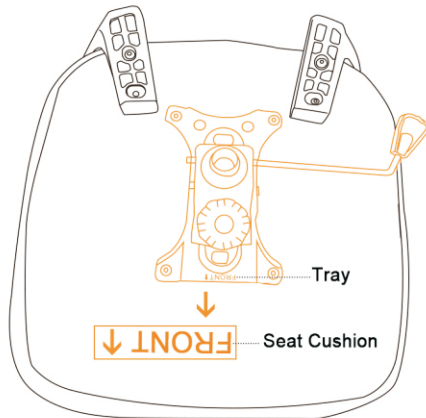

Note: During the assembly, please first half-tighten all the screws into the holes. After all the screws are set, fully tighten them.

STEP 4



Please notice the direction of the tray and the seat cushion
Keep the same direction as indicated

STEP 5

(E)		x1
(J)		x4
(K)		x4
(L)		x8

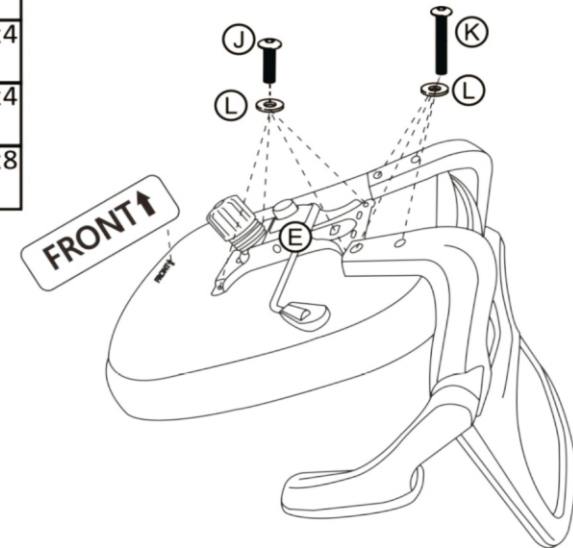

STEP 6

