

# INSTALLATIONGUIDE

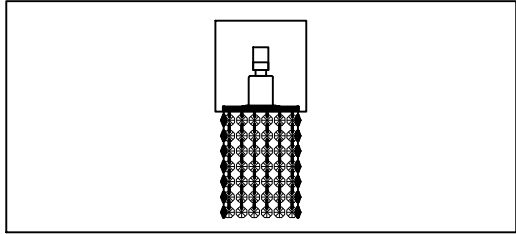

## TOOLS YOU MAY NEED

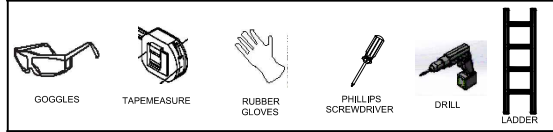

## PARTSLIST

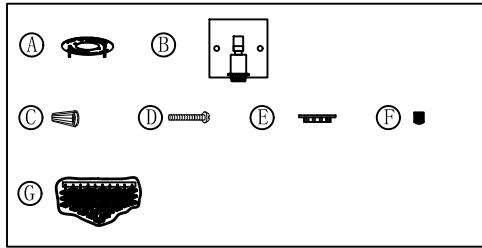

- A. Mounting bracket x1
- B. Lamp body x1
- C. The Junction Caps x3
- D. Mounting bracket screw x2
- E. Socket rings x1
- F. Nut x2
- G. Crystal x1

## CIRCUITBOX

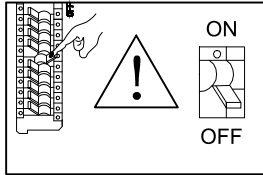

Please read and understand the entire manual before attempting to assemble, operate, or install the product.

Make sure that you have all necessary parts by checking the parts list.

All parts must be used as indicated in these instructions. Do not substitute any parts, leave parts out, or use any parts that are worn or broken.

Highly recommends to use a qualified, licensed electrician to install the fixture. 

Recommends to install the fixture on its own independent circuit. Do not install the fixture on the same circuit with the other appliances, or HVAC systems.

**DO NOT CUT WIRES**  attached to the fixture under any circumstance. Cutting wires will VOID your warranty. Excess cable should be neatly looped and tucked into the canopy.

Do not remove or replace parts that is provided with the fixture.

Place the wall switch in the "OFF" position of the room you are installing the fixture.

Shut "OFF" the electricity at main fuse box.

1

# Fixture Diagram

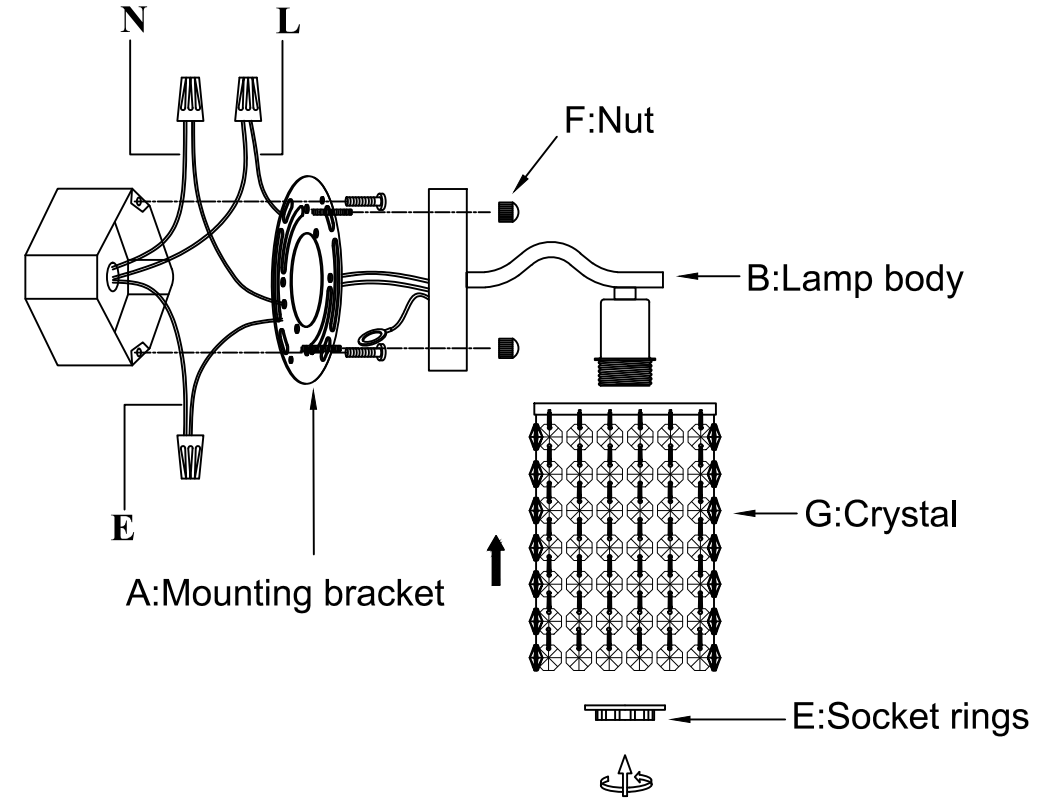

2

# Instructions

If Crystal drop out,pls hang it like pictures, thank you.

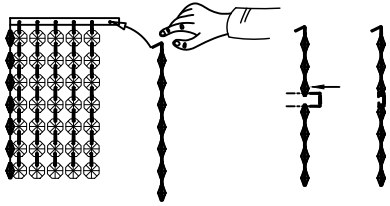

Step 1. Turn power off.

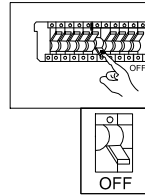

Step 2. Move out the A.

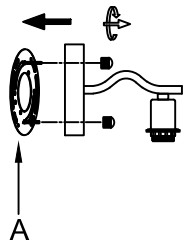

Step 3. Fix the A,universal crossnar to ceiling(junction box) .

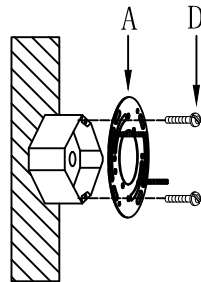

Step 4.

1. Black wire from the wall(junction box) attaches to "L"wire from the fixture.
2. White wire from the wall(junction box) attaches to "N"wire from the fixture.
3. "E" wire from the fixture is attached to the mounting bracket and an additional "E" wire from the mounting bracket must be secured to the junction box. Lock the lamp body to the hanging plate with the (F) nut.

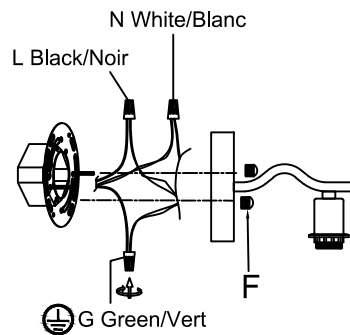

3

Step 5: Loose out socket ring, put on Crystal (G) then tight back socket ring.

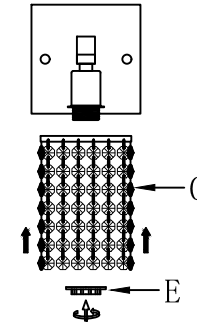

Step 6. fix bulb (not included).

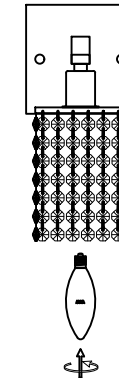

1x E12 60Watt  
Not included  
Non inclus  
LED compatible

Step 7. Turn Power ON

Turn electricity "ON" at main circuit box.

Circuit Box

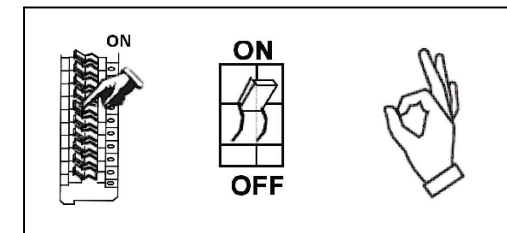

4