

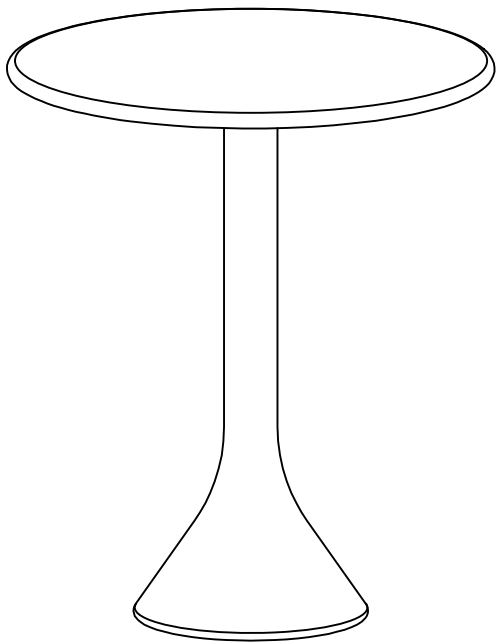



ASSEMBLY INSTRUCTION FOR

MODEL : Vernon Bar Table - Bar



Hardware List			
No	Description	Figure	Q'TY
1	Allen key M4		1
2	Hexagon Bolt M8x15		4
3	Located Bolt M8x40		2

Step 1

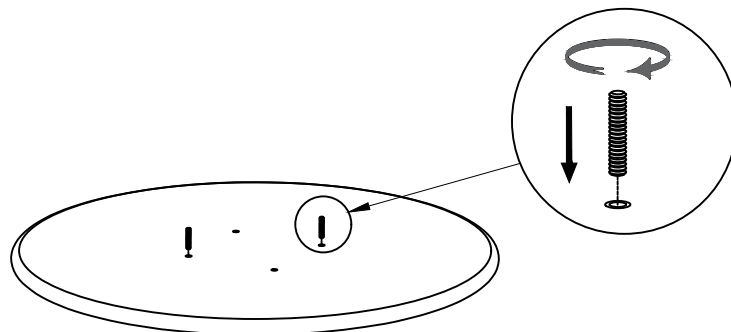

Step 2

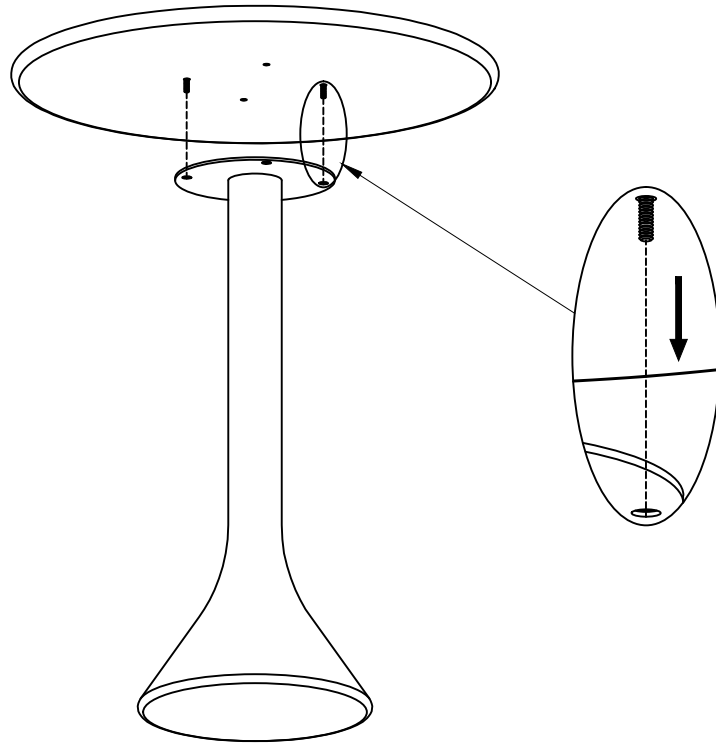

Step 3

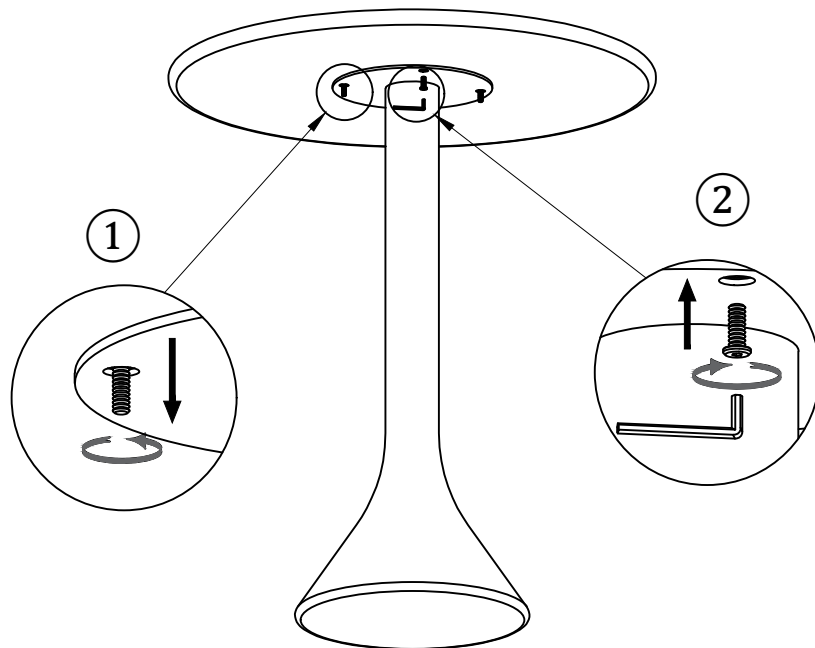

Step 4

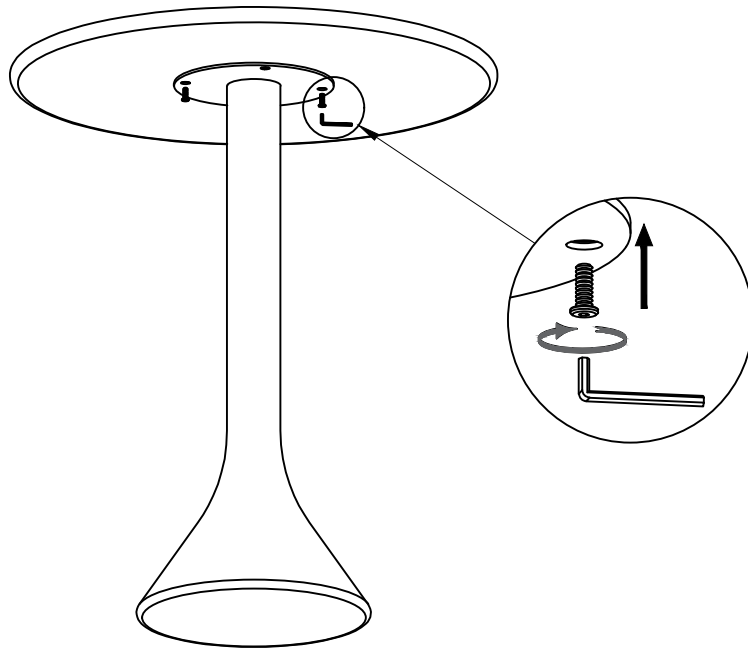

Step 5

