

Installation manual

MYBD6P-W36AL+MYBD6P-W36AL-HD

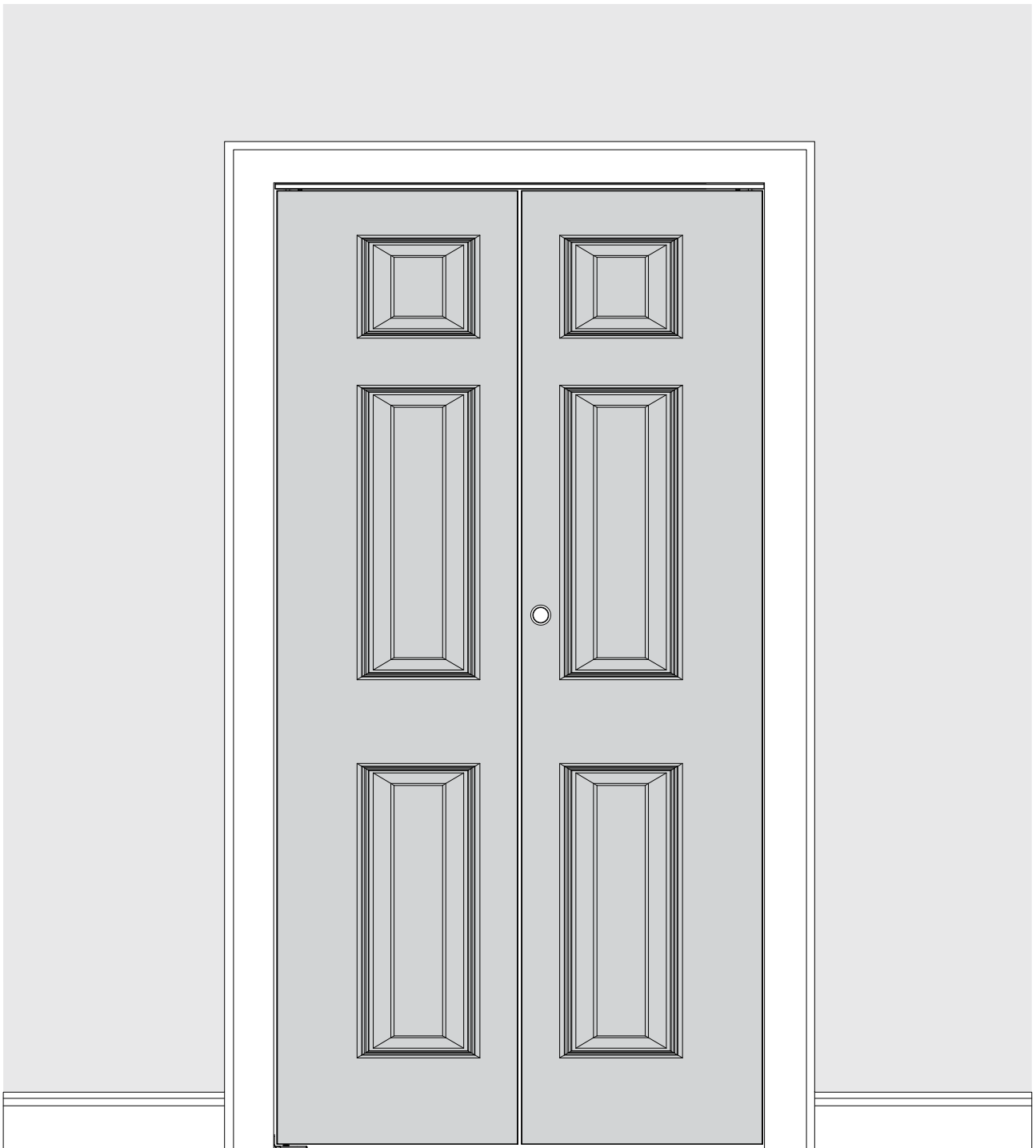



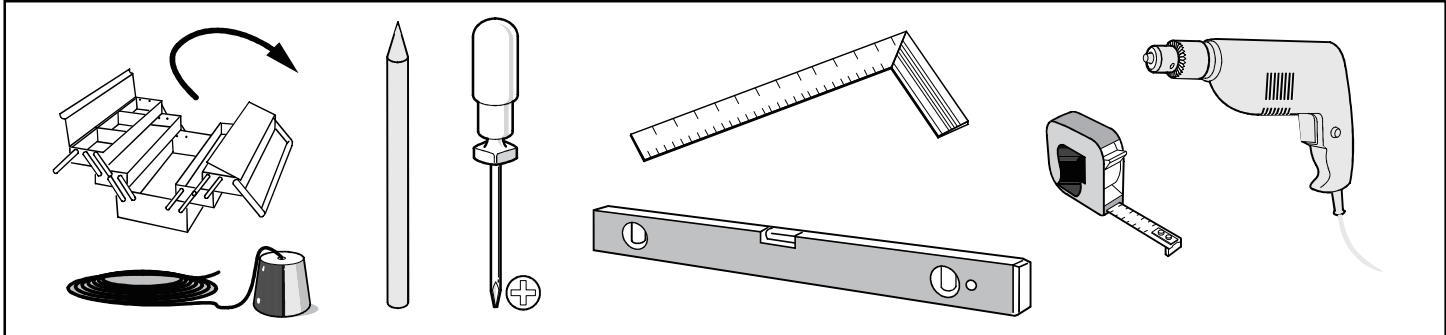

PRE-INSTALLATION

TOOLS REQUIRED

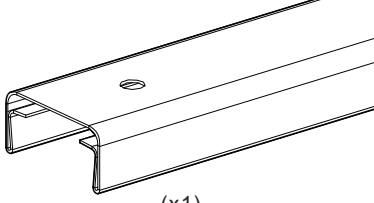
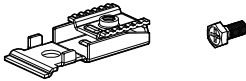
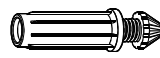
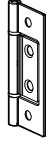
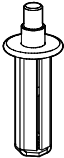
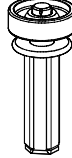

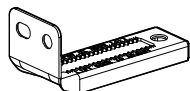
HARDWARE INCLUDED

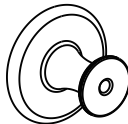
<p>A</p>  <p>(x1)</p>	<p>B</p>  <p>(x1) (x1)</p>	<p>C</p>  <p>(x1)</p>
<p>D</p>  <p>(x3)</p>	<p>E</p>  <p>(x1)</p>	<p>F</p>  <p>(x1)</p>
<p>G</p>  <p>(x1)</p>	<p>H</p>  <p>(x1)</p>	 <p>ST3.5x25 (x12) 9/64"x63/64 "</p>
 <p>ST4.2x38(x7) 11/64"x1 1/2"</p>	 <p>(x1)</p> <p>M4x40(x1) 5/32"x1 37/64"</p> <p>M4x20(x1) 5/32"x25/32"</p>	

To provide feedback on a particular part, please mark it by circling in the instruction manual and kindly send us a photo.

Components list

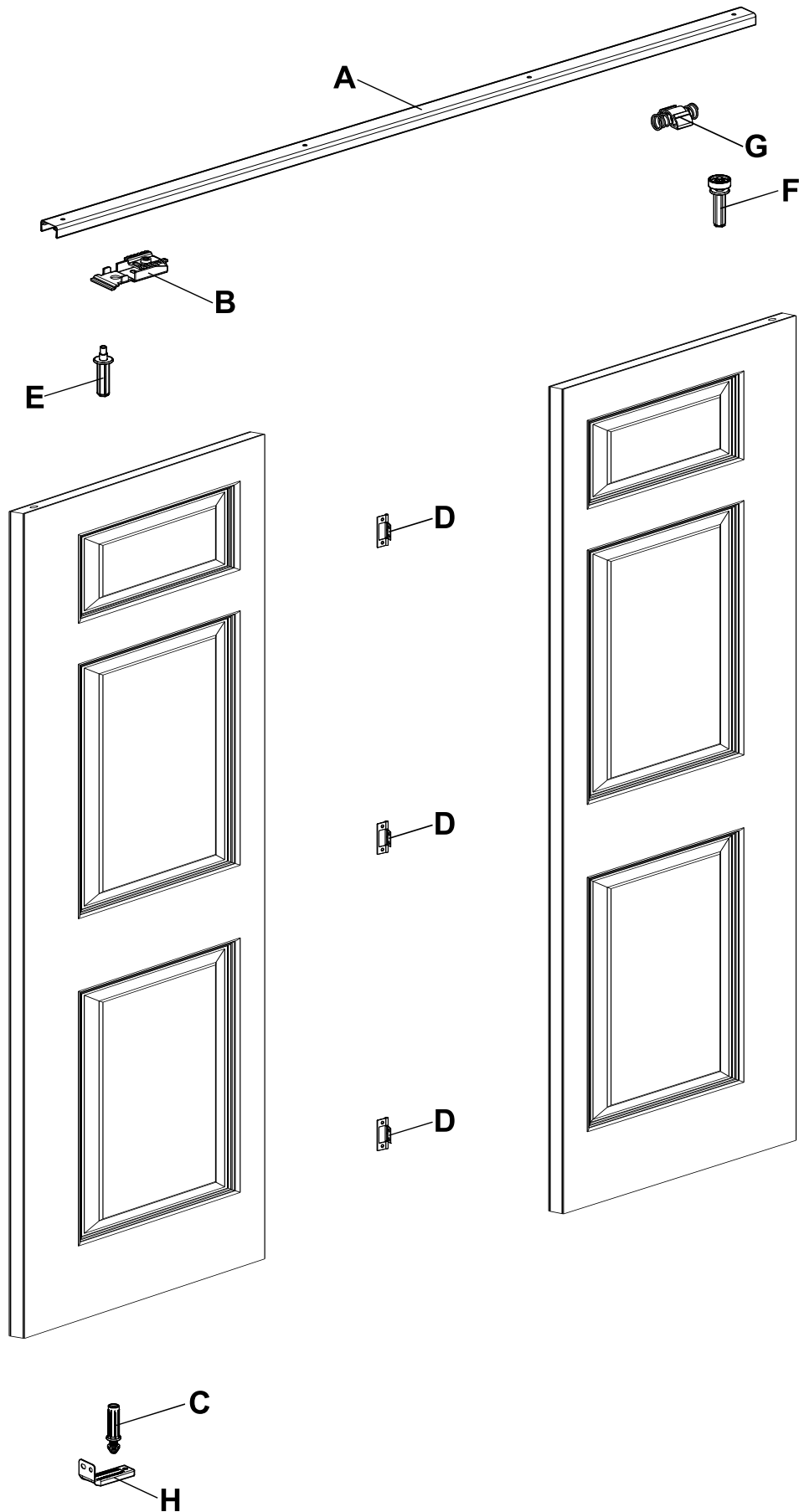

INSTRUCTIONS

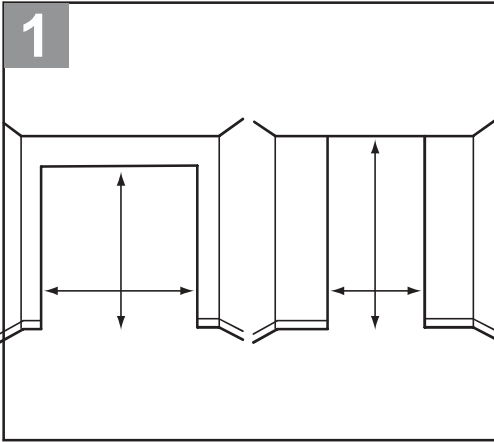

1. Measure accurate height and width of finished opening

Finished Opening: _____ height _____ width _____

Height: Doors must be 1-5/8" (41mm) less than height of net opening.

Width: Divide width of net opening by number of door panels (2 or 4), then subtract 1/4" (6.3mm) to calculate width of net door panel.

Example:

A 30" opening for a two door bifold requires door panels that are 14-3/4" wide ($30/2 - 1/4 = 14 - 3/4$).

A 48" opening with 4 panels requires door panels that are 11-3/4" wide ($48/4 - 1/4 = 11 - 3/4$).

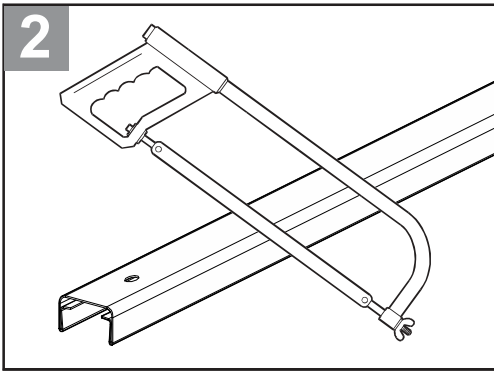

2. Cut Track

If necessary, cut track to 1/8" (3mm) less than the width of finished opening. Use a fine tooth hacksaw.

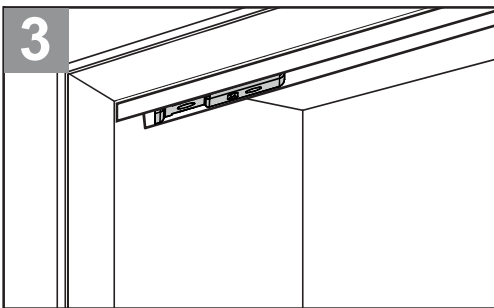

3. Install Track

Ensure the pivot bracket in track is at the inside that you want doors to open toward. Then use **ST4.2x38** screws provided to fasten track along the center line of the header.

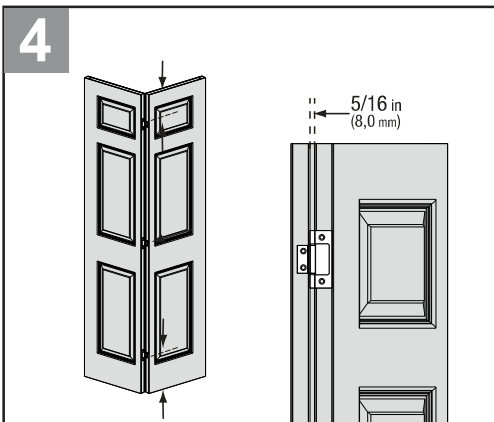

4. Fasten hinges to door panels

Fasten hinges onto the edges of the door panels, using **ST3.5x25** screws provided.

Note that hinges must not be mortised (insert) into door edges.

Ensure that the wider side of hinge is on pivot-side door panel. Place one hinge in the center and the others approximately 6" (15cm) from top and bottom.

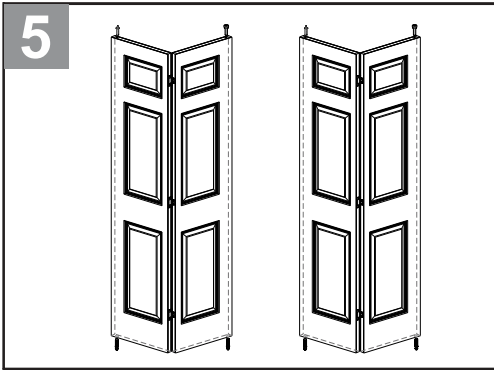

5. Tap in pivots and guide

Tap top pivots into place, apply several light taps on top of pivots. This will allow pivots to seat in correctly. Repeat for bottom pivots.

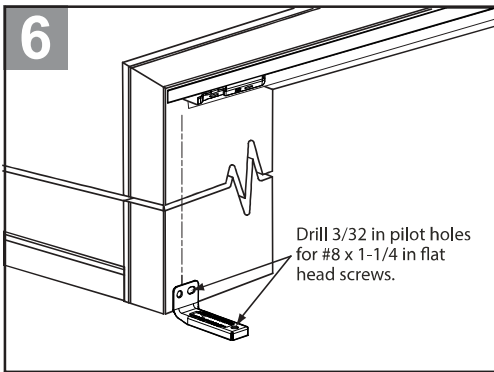

6. Install jamb bracket

Place jamb bracket tight to floor, make sure center hole of bracket is plumb with hole in top pivot bracket (in track). Fasten to side jamb of opening using #8 x 1- 1/2" screws. It may be necessary to remove existing baseboard to ensure flush fit.

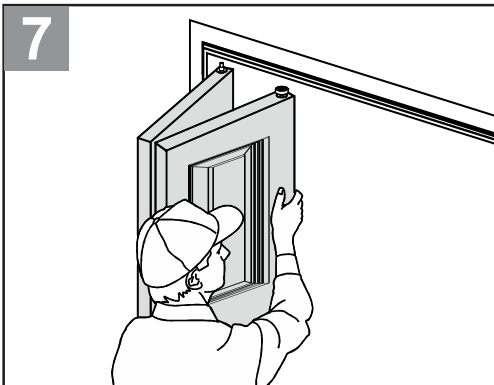

7. Install hinged pair of doors

Insert top pivot pin into hole, lift doors while compressing pin spring and seat bottom pivot pin into jamb bracket slot. Compress guide pin, swing door under track and release roller into track channel.

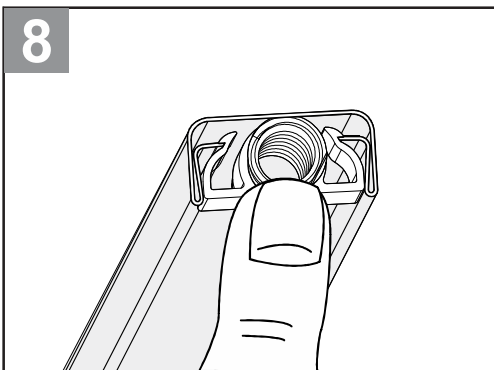

8. Install snagger into track

For 4-panel installations: Press spring snagger into track between pairs of doors.

For 2-panel installations: Press snagger into track between guide roller and jamb.

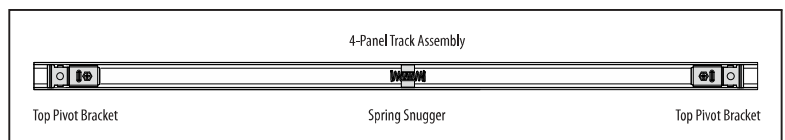
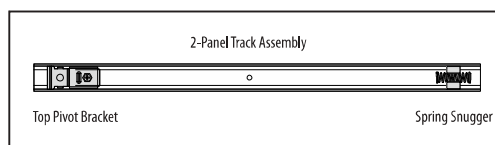

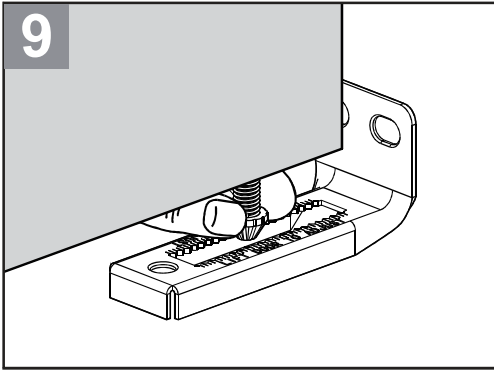

9. Adjust door height

Lift door and remove bottom pivot bolt from jamb bracket. Rotate bottom pivot bolt to adjust for proper height. Rotate clockwise to raise door, counter-clockwise to lower door.

Note: Do not turn pivot bolt while engaged in the jamb bracket.

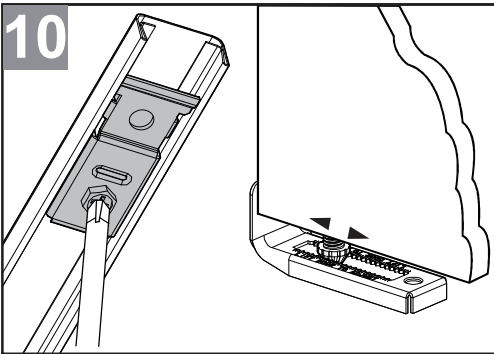

10. Adjust door for proper alignment

Lift door and slide bottom pivot bolt into desired position. Use screwdriver to loosen screw in top pivot bracket, then slide it until door is plumb. Tighten screw to secure top pivot bracket.

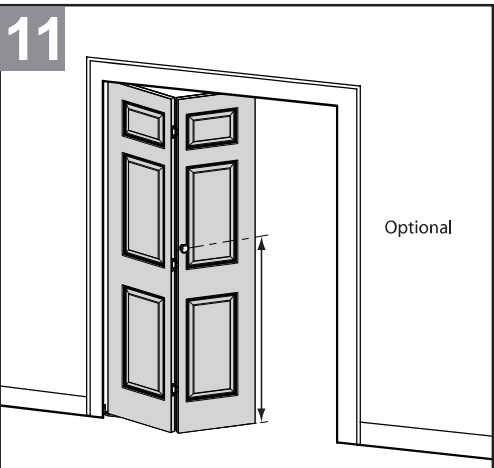

11. Install door pull

Drill hole in the center of the guide door panel, approximately 36" -40" (914mm-1016mm) from the floor. Insert **M4x20** or **M4x40** screw provided from back and fasten pull.