

Assembly Instruction

CAUTION: Read instruction carefully and turn electricity off at main circuit breaker panel before beginning installation.

Size:W22.8"*H9.84"*E6.89"

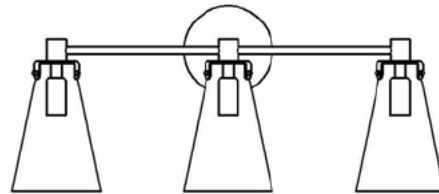

Care and Cleaning









To clean the outside of the fixture, use a dry or slightly dampened clean cloth (use clean water, never a solvent) to wipe the surface of the fixture.

To clear the inside of the fixture, first disconnect power to the fixture by turning off the circuit breaker or by removing the fuse at the fuse box. Next, use a dry or slightly dampened clean cloth (use clean water, never a solvent) to wipe the interior surface of the fixture.

Do not use any cleaners with chemical, solvents or harsh abrasives. Use Only a dry soft cloth to dust or wipe carefully.

Estimated Assembly Time:30 minutes

Part List and Hardware List

PIECE	DESCRIPTION	PICTURE	QUANTITY	PIECE	DESCRIPTION	PICTURE	QUANTITY
A	Mounting bar		1X	B	Fixture body		1X
A1	Mounting screw		2X	C	Bulb		3X
A2	Round nut		2X	D	Glass		3X
B1	Wire nut		3X	D1	Round nut		9X

Installation

Step 1

installing the mounting bar(A) with mounting screw(A1

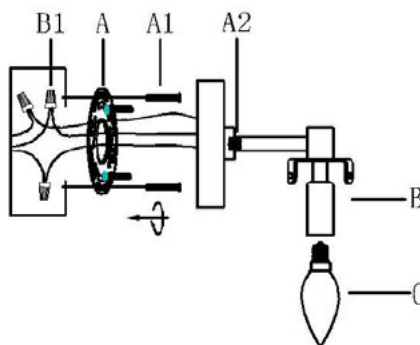

Step 2 Wire connection

Connect,Hot,Black or Red outlet Supply Wire to:	Connect,Neutral,White Outlet Supply Wire to:
Black	White
*Parallel Cord(round&smooth)	*Parallel Cord(square&ridged)
Clear,Brown,Gold or Black without Tracer(colored stripes)	Clear,Brwn,Gold or Black without Tracer(colored stripes)
Insulated Wire(not green)with copper metal conductor	Insulated Wire(not green)with Silver metal conductor

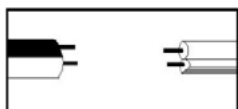

*Note: When parallel wire(SPTI&SPTII)is used. The neutral wire is square shaped and ridged and the hot wire will be round in shape and smooth.(See illustration on left)

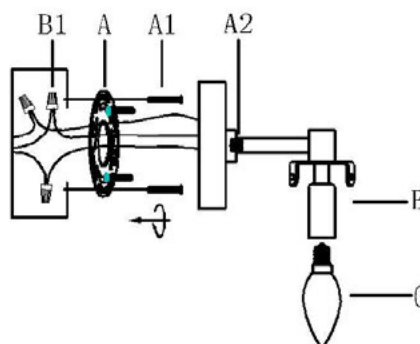
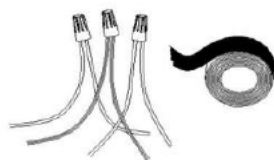

Step 3

- 1.Secure the fixture body(B) with round nut(A2).
- 2.Place the bulb(C) to the socket.
- 3.Install the glass(D) to the fixture body(B) with round nut(D1).

PLEASE USE ON/OFF TYPE "B" BULB MAX 40-WATT
 OR CFL BULB MAX 13-WATT
 OR LED BULB MAX 9-WATT
 THERE ARE 3PCS 4W LED BULB IN THE BOX.

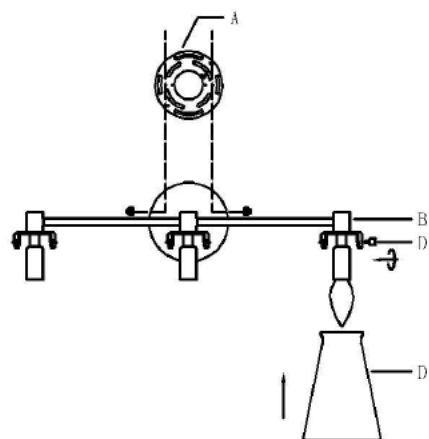

Step 4

Consult a qualified electrician to ensure correct branch circuit conductor