

INSTRUCTION MANUAL

Electric Fireplace

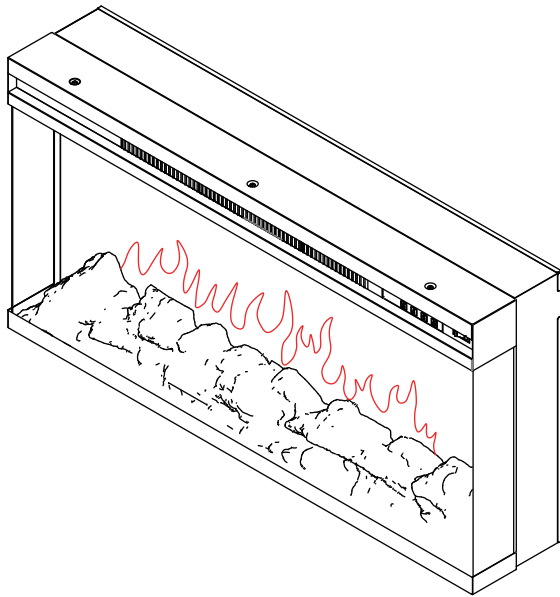

Oneinmil furniture

We are a professional furniture provider with top-notch factories and outstanding designs, Our mission is to provide consumers with new lifestyles. By collecting consumer feedback, we constantly improve our products and create more choices for consumers.

If you want to create your space,

We are an ideal choice.

————— Always. —————



WARNING

**READ AND UNDERSTAND
THIS ENTIRE OWNER'S
MANUAL, INCLUDING ALL
SAFETY INFORMATION,
BEFORE PLUGGING IN OR
USING THIS PRODUCT.
FAILURE TO DO SO COULD
RESULT IN FIRE, ELECTRIC
SHOCK, OR SERIOUS
PERSONAL INJURY.**



CAUTION

KEEP THIS OWNER'S
MANUAL FOR FUTURE
REFERENCE. IF YOU SELL
OR GIVE THIS PRODUCT
AWAY, MAKE SURE THIS
MANUAL ACCOMPANIES
THIS PRODUCT.



AS THIS ITEM CONTAINS MANY PARTS, PLEASE READ THE INSTALLATION INSTRUCTION CAREFULLY BEFORE INSTALLATION. PLEASE USE TOOLS PROPERLY AND CAREFULLY.

IF YOU HAVE ANY QUESTIONS ABOUT THE PRODUCT AND INSTALLATION, PLEASE CONTACT US. OUR PROFESSIONAL AFTER-SALES TEAM WILL SERVE YOU ONLINE ALL DAY.

IMPORTANT SAFETY INFORMATION!

WARNING

When using electrical appliances, basic precautions should always be followed to reduce the risk of fire, electric shock, and injury to persons, including the following:

1. Read all instructions before installing or using this heater.
2. This heater is hot when in use. To avoid burns, do not let bare skin touch hot surfaces. Keep combustible materials, such as furniture, pillows, bedding, papers, clothes, etc. and curtains at least 0.9 m from the front of the heater and keep them away from the sides and rear.
3. Extreme caution is necessary when any heater is used by or near children or invalids and whenever the heater is left operating and unattended.
4. Do not operate any heater after it malfunctions. Disconnect power at service panel and have heater inspected by a reputable electrician before reusing.
5. Do not use outdoors.
6. To disconnect heater, turn controls to off, and turn off power to heater circuit at main disconnect panel (or operate internal disconnect switch if provided).
7. Do not insert or allow foreign objects to enter any ventilation or exhaust opening as this may cause an electric shock or fire, or damage the heater.
8. To prevent a possible fire, do not block air intakes or exhaust in any manner.
9. The meaning of figure in marking is "WARNING: DO NOT COVER". 
10. A heater has hot and arcing or sparking parts inside. Do not use it in areas where gasoline, paint, or flammable vapors or liquids are used or stored.
11. Use this heater only as described in this manual. Any other use not recommended by the manufacturer may cause fire, electric shock or injury to persons.

12. This heater is for use on 120 volts. The cord has a plug as shown at A in Figure below, An adapter as shown at C is available for connecting three-blade grounding-type plugs to two-slot receptacles. The green grounding lug extending from the adapter must be connected to a permanent ground such as a properly grounded outlet box. The adapter should not be used if a three-slot grounded receptacle is available.

Grounding methods

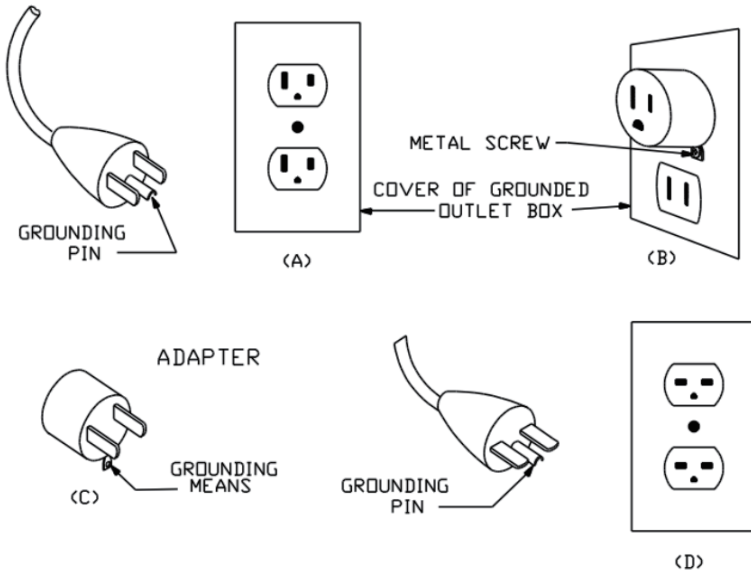

NOTE: Adaptors are NOT for use in Canada.

13. SAVE THESE INSTRUCTIONS.

TECHNICAL SPECIFICATIONS

Model NO: FC407BK02A-LC, FC407BK01A-LC

supply Voltage: AC120V 60Hz

Maximum power consumption: 1500W

Power for flame and fuel bed effect

FC407BK01A-LC	FC407BK02A-LC
12W	15W

TOOLS REQUIRED



PHILLIPS
SCREWDRIVER



DRILL &
NO.6 DRILL BIT



PENCIL
& RULER

+ AAA - 2 AAA BATTERIES



LEVELER



2Persons Assembly



Minimum 30 Minutes For Assembly

PARTS & HARDWARE

- Unpack the fire carefully, make sure that the appliance is intact with no signs of damage caused by transport and no part has been exposed to water. If in doubt, do not use the appliance and contact an authorized service center.
- Keep plastic wrapping away from children.
- Save the original packaging as this may be required in the event of service complaint with product.
- Check that all parts are removed from the packaging.

A

Fireplace

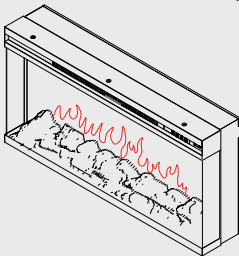

1 PC

B

Remote Control

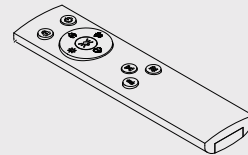

1 PC

C

AAA Battery

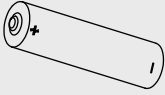

2 PC

D

Mood light Strip



2 PC

E

Connecting Wire A

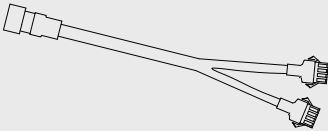

1 PC

F

Connecting Wire B

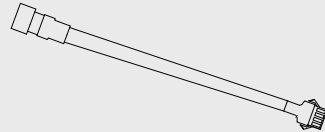

1 PC

G

ST4*8 Screw

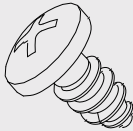

4 PC

H

ST4*12 Screw

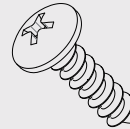

2 PC

I

ST3*12 Screw

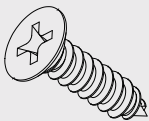

4 PC

J

Fixing Bracket

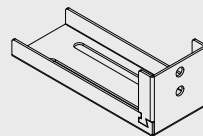

2 PC

K

Mood Light Strip Bracket

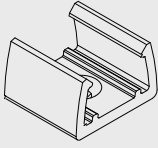

4 PC

L

User Manual

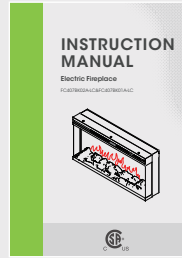

1 PC

APPLIANCE DIMENSIONS

Unit:mm

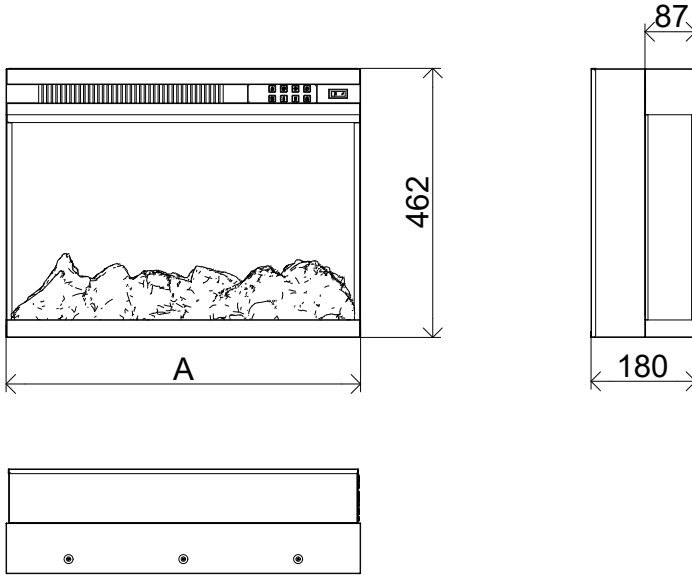

Model	FC407BK01A-LC	FC407BK02A-LC
A	610	915

INSTALLATION INSTRUCTIONS

Tools Required

A screw driver will be needed.

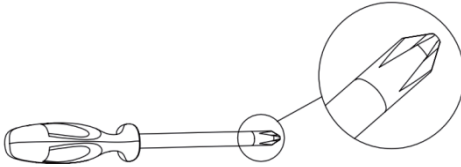

Locating the Appliance

Your new electric fireplace may be installed virtually anywhere in your home. However, when choosing a location ensure that the general instructions are followed.

1.1 For best result, install out of direct sunlight.

1.2 The appliance should be connected to an earthed electrical outlet and it must be easily accessible to allow disconnection.

Prepare the Electrical Supply

- Plan the location of the appliance so that it will have adequate electric power. A 15 AMP, 60Hz circuit is required for 120V installation. The appliance should ideally be located close to a suitable main socket to enable power connection.
- Always make sure the outlet is in good condition and the plug is not loose. NEVER exceed the maximum amperage of the circuit.

Installing the Appliance

- 1 Insert the fireplace into the compatible mantel as shown in the below picture.

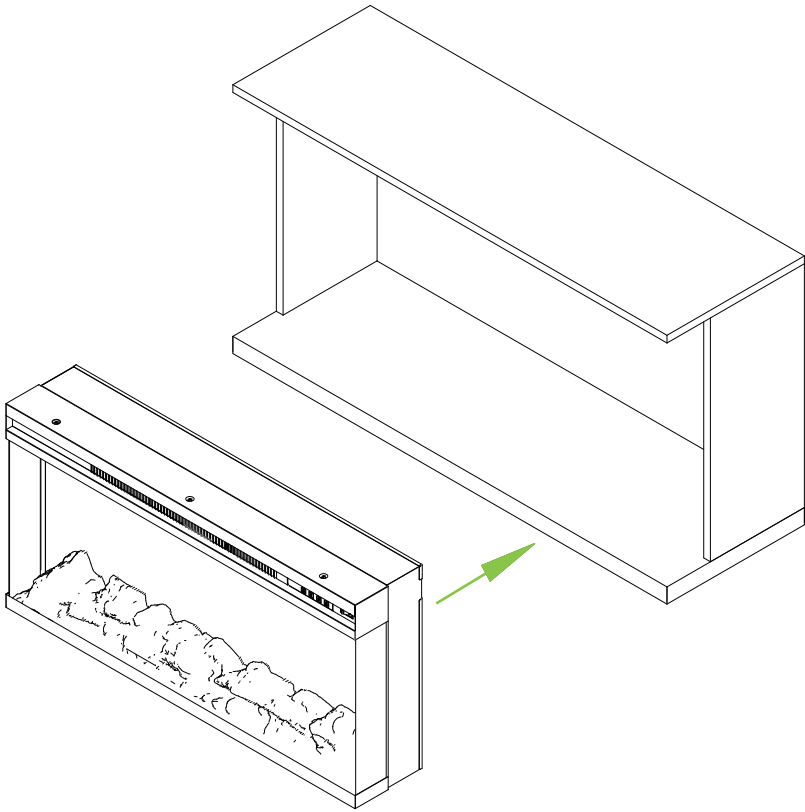

Installing the Appliance

- 2** Install two fixing brackets either on the bottom panel or sidepanels of the mantel as shown in the below picture. Secure the fixing brackets with 4pcs ST4*8 screws and 2pcs ST4*12 screws.

a. Install the fixing brackets on the bottom panel of the mantel.

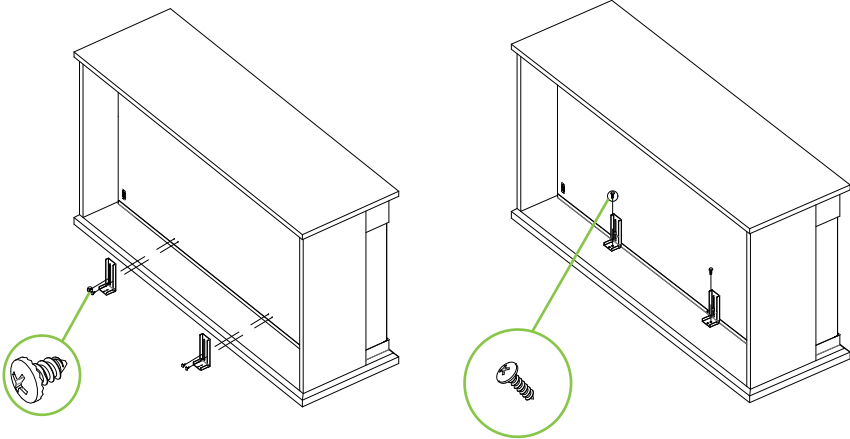

b. Install the fixing brackets on the side panels of the mantel.

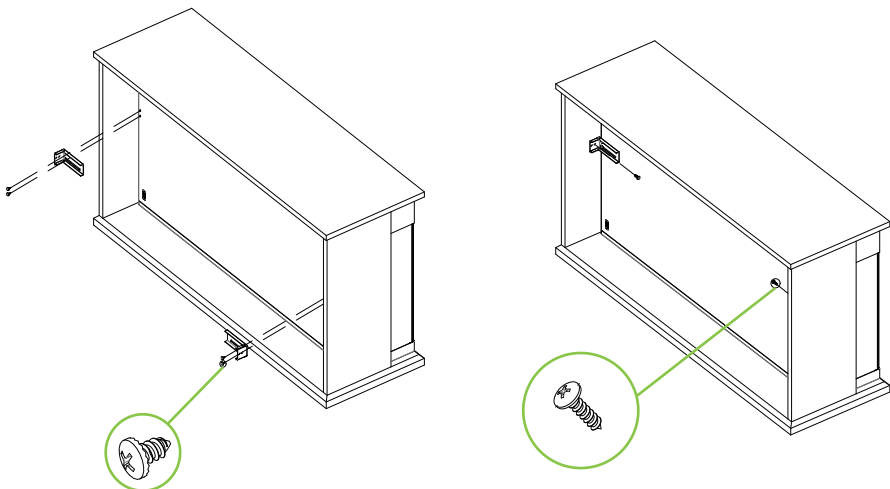

Installing the Appliance

3

Connect mood light strips with the compatible connecting wire. Confirm where you want to locate the mood light strips, fix the mood light strip brackets with ST3x12 screws, and then install the mood light strips into the brackets.

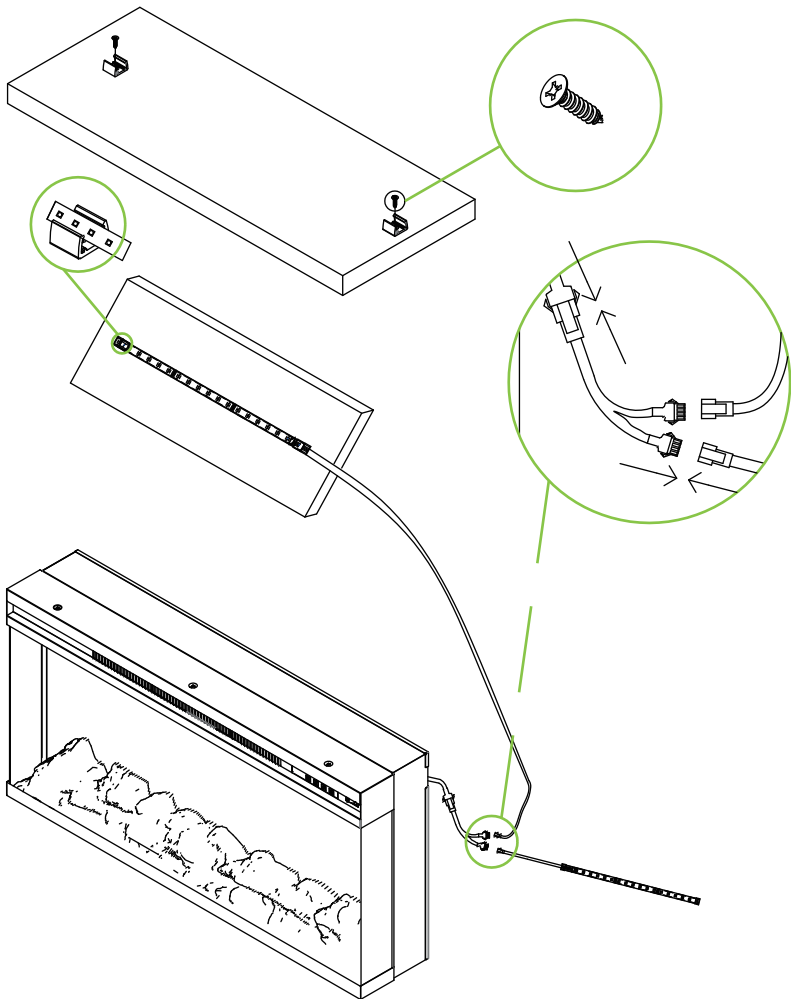

OPERATING INSTRUCTIONS

1. GENERAL





WARNING! Do not operate the appliance if it is damaged or has malfunctioned. If you suspect the appliance is damaged or has malfunctioned, call a qualified service engineer to inspect the appliance, and replace any part of the electrical system if necessary before re-use.



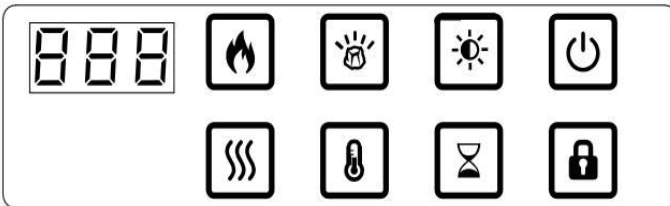

WARNING! To reduce the risk of fire, keep textiles, curtains, or any other flammable material a minimum distance of 1 meter from the air outlet.

- **MAKE SURE** the plug fits tight in the outlet. Faulty wall outlet connections or loose plugs can cause the outlet to overheat.
- **DO NOT** disconnect the power at the mains supply whilst the appliance is running.





2. MANUAL CONTROL PANEL





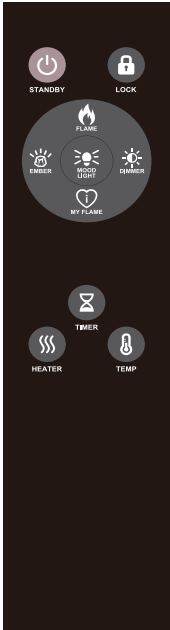



Name	Function	Product display
 Stand by	Press to turn on the flame, fuel bed and mood light or to turn off all function and memorize the flame, ember, mood light effects and the setting temperature.	Digital tube displays current temperature.
 Flame	When digital tube displays other functions, press once to enter the flame query state. Keep on pressing to cycle through 12 flame effects and off setting.	Digital tube displays F.01, F.02..F.13, F.00.
 Ember	When digital tube displays other functions, press once to enter the ember query state. Keep on pressing to cycle through 12 ember effects and off setting	displays Digital tube E.01, E.02, ... E.12, E.00.
 Dimmer	When digital tube displays other functions, press once to enter the flame/ember brightness query state. Keep on pressing to cycle through 5 levels of flame/ember brightness. When digital tube displays mood light function, press once to enter the mood light brightness query state. Keep on pressing to cycle through 5 levels of mood light brightness.	Digital tube displays br.5, br.4, ... br.1 (flame/ember brightness) or bb.5, bb.4, ... bb.1 (mood light brightness).

 <p>Heater</p>	<p>When digital tube displays other functions, press once to enter the heater query state, keep on pressing to cycle through Heat Low /High /OFF Heater can be turned on without flame.</p>	<p>Digital tube displays H.Lo,H.HI and H.oF Digital tube will keep on, displaying H.Lo or H. HI accordingly.</p>
 <p>Temperature</p>	<p>Press to cycle through 60°F-84°, F99°F(16°C -28 °C,58 °C), totally 14 settings. Long press 3s to change between °F and °C. When digital tube doesn't display temperature, press once to query the current setting temperature.</p>	<p>Digital tube displays the corresponding temperature.</p>
 <p>Timer</p>	<p>Press to cycle through off, 0.5H, 1H,2H...9H, totally 11 settings. When the timing ends, the product will enter the standby state.</p>	<p>Digital tube displays the corresponding time.</p>
 <p>Child Lock</p>	<p>When digital tube displays other functions, press once to enter the child lock query state, keep on pressing to turn on or off child lock.When child lock is on, other buttons will be invalid.</p>	<p>Digital tube displays L.on or L.oF</p>
 <p>ON/OFF</p>	<p>Press " I " to turn on the power and press "O" to turn off the power.</p>	<p>A long beep indicates the power is on.</p>

3.REMOTE HANDSET

	Button	Function	Product display
	 Stand by	Press to turn on the flame, fuel bed and mood light or to turn off all function and memorize the flame, ember, mood light effects and the setting temperature.	Digital tube displays current temperature.
	 Flame	When digital tube displays other functions, press once to enter the flame query state. Keep on pressing to cycle through 12 flame effects and off setting.	Digital tube displays F.01,F.02,...F.12,F.00.
	 Ember	When digital tube displays other functions, press once to enter the ember query state. Keep on pressing to cycle through 12 ember effects and off setting.	Digital tube displays E.01,E.02,...E.12,E.00.
	 Dimmer	When digital tube displays other functions, press once to enter the flame/ember brightness query state.Keep on pressing to cycle through 5 levels of flame/ember brightness. When digital tube displays mood light function, press once to enter the mood light brightness query state.	Digital tube displays br.5,br.4,...br.1 (flame/ember brightness) or bb.5,bb.4,...bb.1 (mood light brightness).

		Keep on pressing to cycle through 5 levels of mood light brightness.	
	My Flame	Long press to memorize the current state.Short press to enter or cancel my flame.	No display.
	Mood Light	When digital tube displays other functions, press once to enter mood light query state. Keep on pressing to cycle through 12 mood light effects and off setting.	Digital tube display b.01,b.02,...b.12,b.00.
	Timer	Press to cycle through off,0.5H, 1H, 2H...9H, totally 11 settings. When the timing ends,the product will enterthe standby state.	Digital tube displays the corresponding time.
	Heater	When digital tube displays other functions, press once to enter the heater query state, keep on pressing to cycle through Heat Low/ High /OFF Heater can be turned on without flame.	Digital tube displays H.Lo,H.HI and H.oF. Digital tube will keep on, displaying H.Lo or H.HI accordingly.
	Temperature	Press to cycle through 60°F-84°, F99°F(16°C -28 °C,58 °C), totally 14 settings. Long press 3s to.change between °F and °C .When digital tube doesn't display	Digital tube displays the corresponding temperature.

		<p>temperature, press once to query the current setting temperature.</p>	
	 <p>Child Lock</p>	<p>When digital tube displays functions, press once to enter the child lock query state, keep on pressing to turn on or off child lock.</p> <p>When child lock is on, other buttons will be invalid.</p>	<p>Digital tube displays L.on or L.oF</p>

RESETTING THE THERMAL CUT OUT

The appliance is fitted with an Electronic Safety Control (E.S.). This is a safety device which switches off the fire if, for any reason, the appliance overheats, e.g. when covered. If the heater stops operating while the flame effect continues working normally, this indicates that the E.S. Control is in operation. The E.S. control can only be re-set after the appliance has cooled down, and the appliance has been reset. Resetting of the E.S. Control procedures are as follows:

1. Press button **STAND BY** on fire to turn off the appliance and leave it off for approximately 10-15 minutes.
2. Remove any obstruction to the fan heater outlet or fan blades etc. Make sure that the power supply is disconnected with the plug socket outlet while doing this.
3. Turn on the appliance and the E.S. Control will be reset.
4. Ensure that the appliance is functioning correctly. If the E.S. Control operates again, the appliance should be checked by a competent electrician.

GENERAL

WARNING! ALWAYS turn the heater OFF and unplug the power cord from the outlet before cleaning, performing maintenance, or moving this fireplace. Fail to do so could result in electric shock, fire, or personal injury.

WARNING! NEVER immerse in water or spray with water. Doing so could result in electric shock, fire, or personal injury.

METAL:

- Buff using a soft cloth, slightly dampened with a citrus oil-based product.
- DO NOT use brass polish or household cleaners as these products will damage the metal trim.

GLASS:

- Use a good quality glass cleaner and dry thoroughly with a paper towel or lint-free cloth.
- NEVER use abrasive cleansers, liquid sprays, or any cleaner that could scratch the surface.

PLASTIC:

- Wipe gently with a slightly damp cloth and a mild solution of dish soap and warm water.
- NEVER use abrasive cleansers, liquid sprays, or any cleaner that could scratch the surface.

VENTS:

- Use a vacuum or duster to remove dust and dirt from the heater and vent areas.
- Clean the exterior of the fireplace with a slightly damp cloth or duster.

MAINTENANCE

WARNING! Risk of electric shock! DO NOT OPEN! No user-serviceable parts inside!

Electrical and Moving Parts:

- The fan motors are lubricated at the factory and will not require lubrication.
- Electrical components are integrated in the fireplace and are not serviceable by the consumer.

Replacement Parts:

- Use only replacement parts supplied by the manufacturer. Use of any other parts, or modifying the fireplace in any way, will void all warranties.

LIMITED WARRANTY

This warrants to the original purchaser that this product is free from defects in material and workmanship as of the date of purchase and that it will, under normal use and proper care, remain so for one year from the date of purchase. Missing or initially defective parts will be replaced free of charge during the period of this limited warranty. If parts are unavailable, comparable replacement or refund will be given. **The original dated sales receipt is required for all warranty claims.** This warranty does not cover damage which has occurred during transport from the point of purchase to the consumer's home. This warranty does not cover glass, light bulbs, batteries, transportation, labor, or other issues not associated with the manufacture of the product.

This product is for residential use only. Any and all commercial use of this product voids all warranties, and frees the manufacturer from all liability.

Read and understand all assembly and operating instructions, and all safety information and warnings, before use. The following will void this warranty: Damage caused from tampering with, modifying, or altering the fireplace insert in any manner; Damage due to incorrect assembly, improper care, misuse, or abuse; Damage from being used with the wrong power source; Water damage; Damage caused from this insert being used outdoors; Damage caused from this insert being used for excessive periods of time; Damage caused by the insert being used in a commercial application; Damage from use as a primary heat source; Other misuse or abuse not specifically listed herein.

This product is not intended to be used as a primary heat source. It is for supplemental heating purposes only.

HELP CENTER

Question about your product? We're here to help. Visit us at:

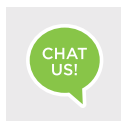

Chat Support

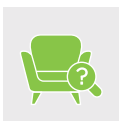

Product Inquiry

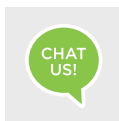

Orders FAQ



Product Assembly

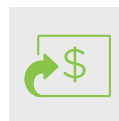

Returns & Refunds

We Stand Behind the Quality of Their Furniture

If you have any issues with your item please let us know! We will always do our best to come up with a solution that you will be happy with.

Please get in touch with our customer service team before returning the product.

And pls do not throw the original box(es) if you have not finished assembling or confirmed no quality issues.

Length of return period:

Items can be returned within 30 days of purchase.

In the meanwhile, everything you purchased from us comes with a one-year warranty.

Who is responsible for the return shipping fee:

We will cover the return shipping fees if:

1. Your item has a manufacturing defect in its materials or workmanship. For example, torn wicker or misaligned screw holes. We will send you a prepaid shipping label after photos are sent.
2. Your item has been damaged in transit. For example, glass is broken or wicker is damaged. We will send you a prepaid shipping label after photos are sent.
3. You receive the wrong box(es) due to a warehouse error. We will send you a prepaid shipping label after photos are sent of the wrong SKU numbers on the outer box(es).
4. One or more boxes are lost in transit. We will send you a prepaid shipping label if you no longer want the item.

*However, we still hope to work with you for a better solution instead of a return. Please don't hesitate to contact our customer service team.

Customer will cover the return shipping fees if:

1. You don't like the product(s) after receiving the box(es).
2. You no longer need the product(s) but you have received the box(es).
3. You buy the product(s) by mistake but you have received the box(es).
4. Order/Shipment cancellation failed and you have received the box(es).

Return Request

In order to get a full refund as described in this return policy, all items must be: (1) In a brand new/unused condition, please provide photos before and after packaging. (2) When returning, all accessories and parts are firmly packed in all original packaging.

If your return does not meet the requirements, you may not get a full refund.

When will I be refunded?

The refund is released once the goods have been returned to our warehouse.

What if the product is damaged/defective outside of the valid return period?

We want you to be a happy customer. Please reach out to us by email and we will come up with a solution to make sure you are satisfied.