





ASSEMBLY INSTRUCTION

- ①  PIN 5/16 6 PCS SOFA PIN
5/16 6 PCS LOVESEAT PIN
5/16 6 PCS ARMCHAIR
- ②  SOFA BUTTERFLY 5/16 6 PCS
LOVESEAT BUTTERFLY 5/16 6 PCS
ARMCHAIR BUTTERFLY 5/16 6 PCS
- ③  SOFA SCREW (12 PCS)
LOVESEAT SCREW (12 PCS)
ARMCHAIR SCREW (12 PCS)
- ④  SOFA LEG (4 PCS)
LOVESEAT LEG (4 PCS)
ARMCHAIR LEG (4 PCS)
- ⑤  SOFA MIDDLE LEG (1 LEG)
LOVESEAT MIDDLE LEG (1 LEG)

ARM ASSEMBLY

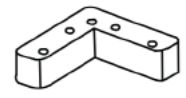

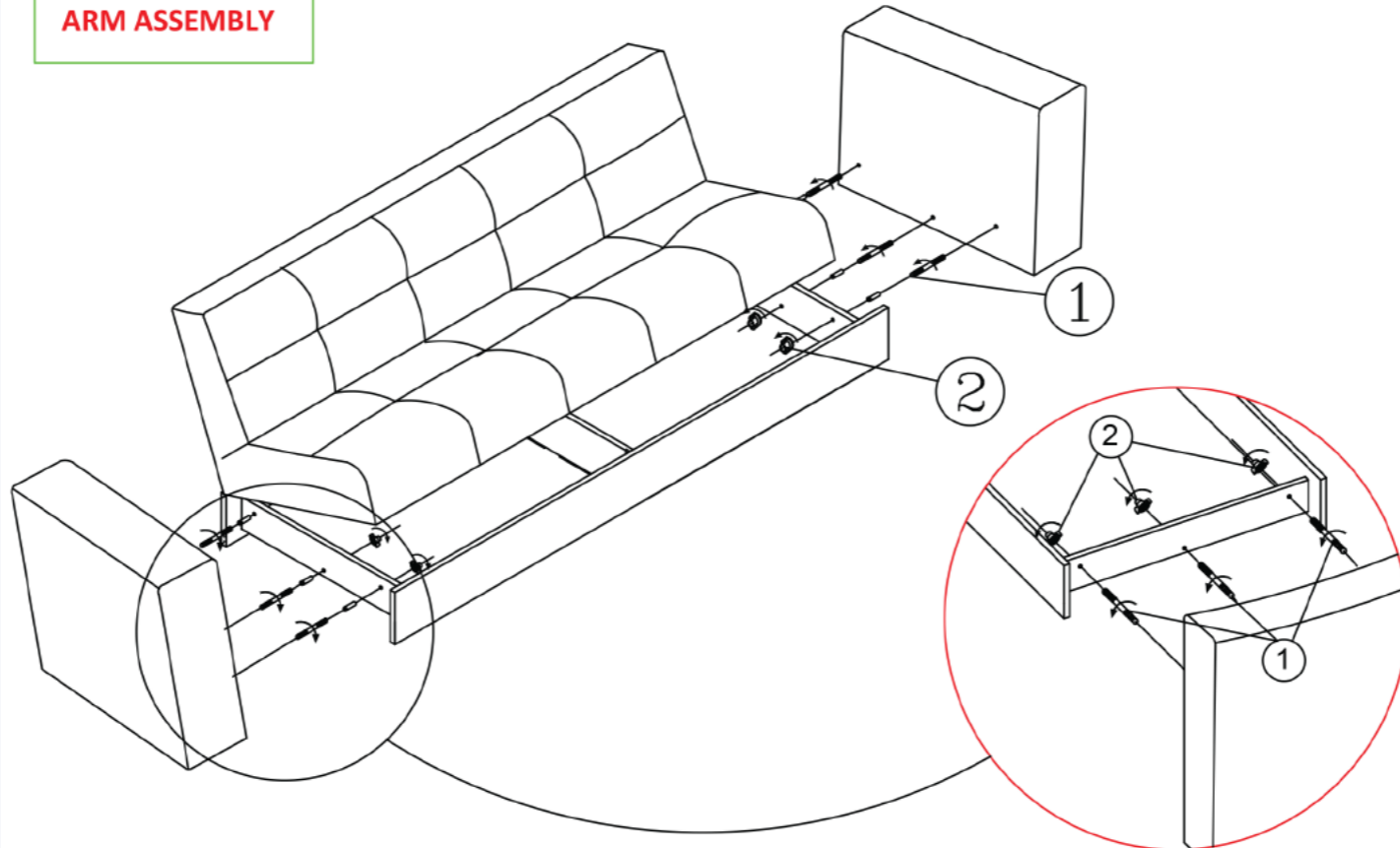
ASSEMBLY INSTRUCTION

A-) LEG ASSEMBLY

1. Sofa is positioned on back as you see picture
2. Sofa legs are connected under arm as you see item 4
3. Supporting leg is connected to sofa as you see item 5

THREE SEATER AND TWO SEATER LEG ASSEMBLY

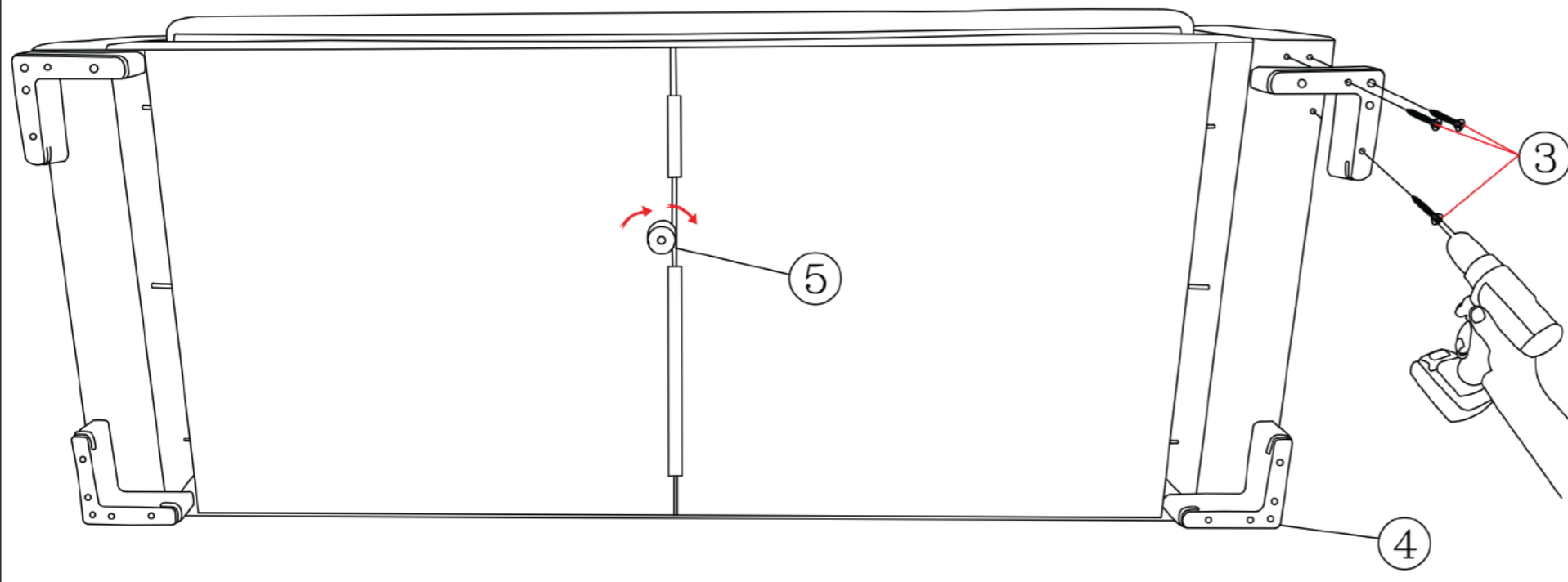

ARMCHAIR LEG ASSEMBLY

