

ASSEMBLY INSTRUCTIONS

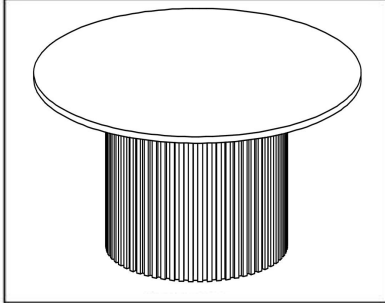

+ Do Not Use
Power Tools



+ Suggested
Adults

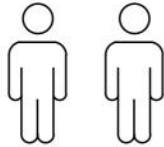

NOTE:

1. Read instructions cover to cover.
2. Save all packaging until assembly is completed.

1. IMPORTANT SAFETY INFORMATION

Do not assemble the product if any of the following parts arrived damaged :

- Part # 1 - Marble top
- Part # 2 - Marble Base

2. IMPORTANT ASSEMBLY INFORMATION

Assembly step :

**Step - 1 Use bolt A, B, C to connect
Part 1 and Part 2.**

Warning : Do not over tighten screws, or it could damage the Table Top.

+Parts Included

(T) Marble Top
(1 pc)

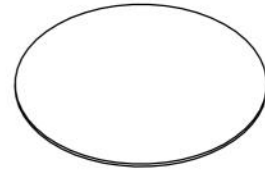

② marble base
(1 pc)

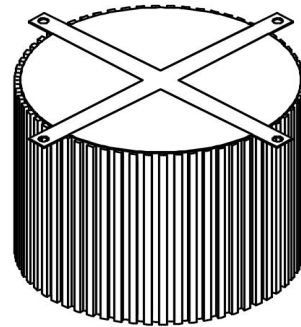

+ Hardware Included

A . Allen Screw 8x16
(4 pc)



B . Screw 20x8
(4 pc)



C. Allenkey 5mm
(1 pc)



ASSEMBLY INSTRUCTIONS

1

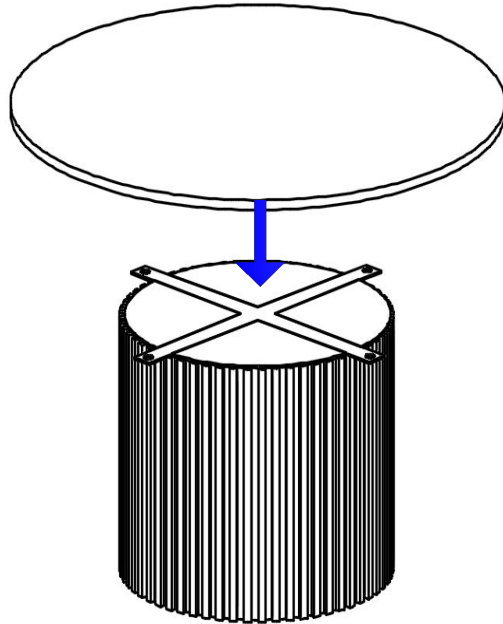

2

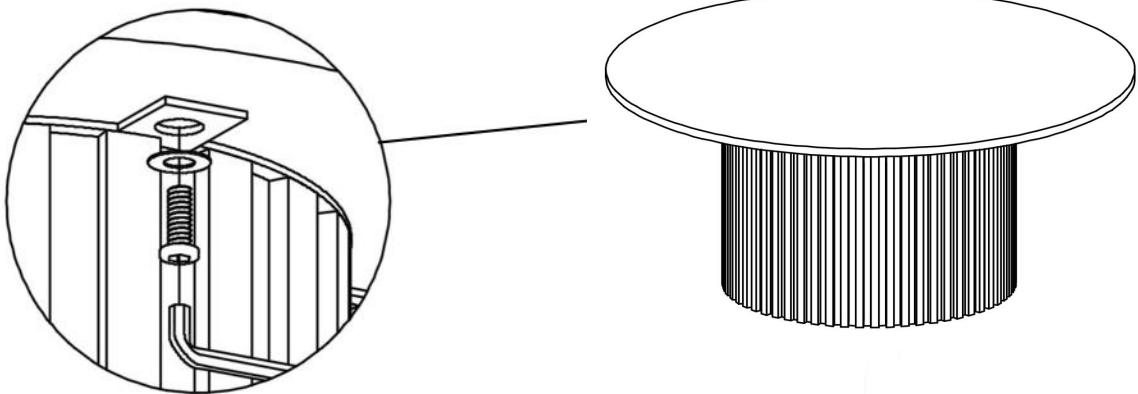

Note: Do not over tighten screws