

Super Washer

Model: 835P

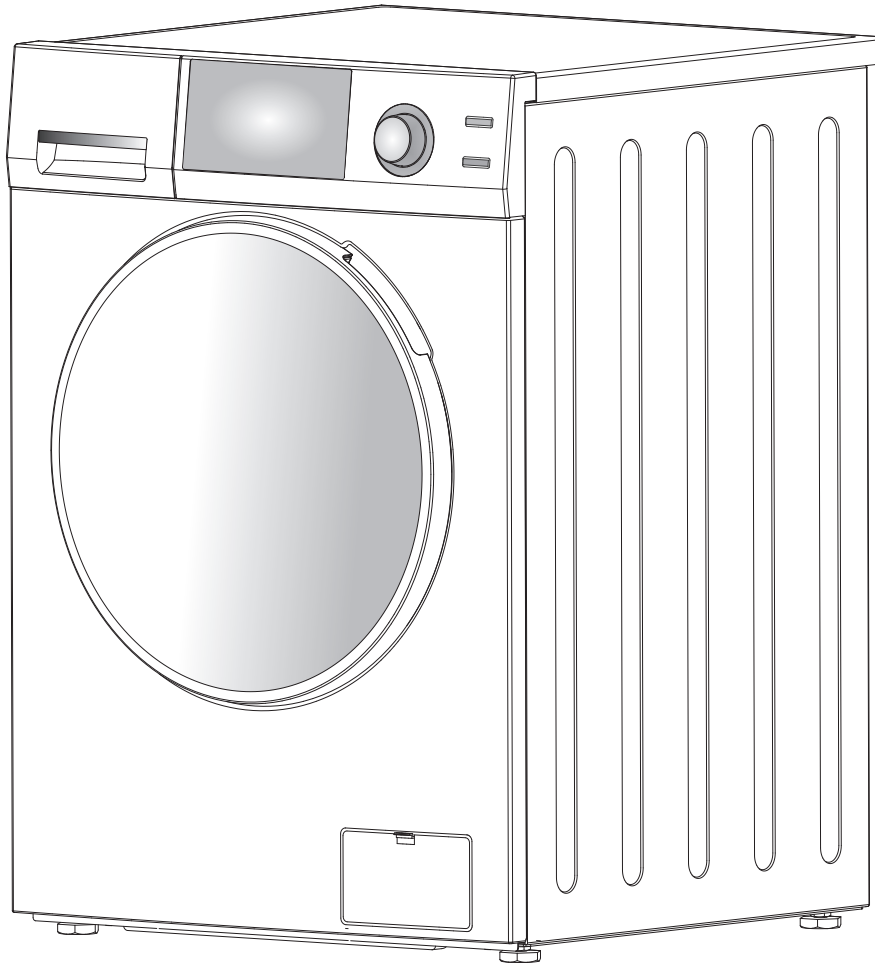

OWNER'S MANUAL

	DO NOT RETURN TO STORE!		1-800-776-3538
	HAVE QUESTIONS OR NEED SERVICE?		Service@ApplianceDesk.com

Read the instructions carefully and keep for future reference. Information maybe updated from time to time so please refer to the website for the latest version of the manual.

TABLE OF CONTENTS

Please read the Owner's Manual carefully before using your Fully Automatic Washer

Introduction	1
Warranty	2
Exclusions	3
Technical Data	4
Important Safety Instructions.....	5
Helpful Hints	6
Pre-installation	6
Diagram of the Combo	7
Installation Instructions.....	8
Unpacking and Leveling	9
Electrical	10
Plumbing	11
Built-In, Recessed, Closet, Alcove Installation	12
Program Selection Chart	13
Operating Instructions	14
Control Panel	15
Display Panel	16
Useful Tips & Understanding Fabric Care Label	17
Maintenance	18
Stain Removal Chart	21
Troubleshooting	23
Diagnostic Menu	24

INTRODUCTION

Congratulations on your new Super Washer! In addition to its contemporary design, this is a highly sophisticated engineered product that will give you many years of satisfaction.

Here are some of the best reasons for buying your Super Washer

1. Easy Operation

This appliance is simple to use as a washer.

2. Improved Operation

With a high spin speed of 1400 rpm, more water is extracted, allowing improved dry times.

3. Convenience

This appliance can be permanently installed and be made portable with the installation of the portability kit (sold separately) where needed.

4. Placement Options

The Washer's sleek design makes it a perfect appliance for any kitchen or laundry room. Its compact size makes the Washer perfect for placement on each floor of your home.

5. Better Clothing Appearance

This Washer has no agitator to damage your clothes so they look better and last longer.

6. Water Savings

This appliance uses very little water for washing and far less than a standard full size top-loading washer. A new feature introduced is automatic water level which helps in saving water as it automatically decides the water intake depending on the quantity of your clothes.

7. Energy Savings

This appliance is engineered to provide valuable energy savings when compared to other washers

8. Maintenance

Since the machine has a self-cleaning pump, this appliance needs no cleaning of lint after every washing. Instead, there is a convenient coin trap.

9. Space Savings

The washer is of optimum size thus saving previous space around your home.

10. Add a sock

In this feature, the program can be stopped at any time to add forgotten items to the wash. Press PAUSE for 5 seconds. Door will open after draining water so that it does not overflow. Load clothes. Close door. Press the START button. Washer will continue from the point it stopped.

WARRANTY INFORMATION

Your appliance is protected by this warranty under normal, personal, family or household use for 1 Year Parts & Labor and limited commercial use (90 days) in USA and Canada.

WARRANTY

Consolidated Brands undertakes to the consumer/owner to repair or, at our option, to replace any part of this product which proves to be defective in workmanship or material under normal personal, family or household use in USA and Canada, for a period of one years parts & labor from the date of original purchase. For commercial use, the product is warranted for a period of 90 days.

During this period, we will provide all labor and parts necessary to correct such defect, free of charge, if the appliance has been installed and operated in accordance with the written instructions provided with the appliance. Ready access to the appliance, for service, is the responsibility of the consumer/owner. If unit installed in closet or cabinet, it should be removed for access by service technician. If this cannot be done, then there will be extra charge.

We may require return of products or parts to our warranty department for which the shipping charges are to be incurred by the consumer. If a return or replacement is required, allow 3-4 weeks to process. If unit is located more than 25 miles there will be a trip charge. If unit is in remote area more than 75 miles, customer will need to take the product to the technician's workshop. Replacement unit will be delivered with curbside delivery only. If Unit is installed in a 5th wheel RV, in a location behind the axle it won't be covered under warranty.

All repairs or replacements are warranted only for the remainder of the original warranty period. Charges may incur if warranty coverage is not applicable. Service would be provided from Monday to Friday between normal business hours.

GENERAL

Since it is the responsibility of the consumer/owner to establish the warranty period by verifying the original purchase date, Consolidated Brands recommends that a receipt, delivery slip or some other appropriate payment record be kept for that purpose. This warranty gives you specific legal rights, and you may also have other rights which vary from State to State.

You can register your Warranty by either of the following methods:

1. Scan QR Code
 - Open Smart Phone
 - Open Camera
 - Click the Link



2. Register online at ApplianceDesk.com/Warranty

Note: QR Code is also used to obtain Product Information, Manuals and Updates

WARRANTY SERVICE

This warranty is given by:

Consolidated Brands
50066 Steffani Lane,
Houston, TX 77041

QUESTIONS / SERVICE

Phone/Text: 1-800-776-3538

Email: Service@ApplianceDesk.com

Web: www.ApplianceDesk.com

EXCLUSIONS

In no event shall Consolidated Brands be liable for incidental or consequential damages or for damages resulting from external causes such as abuse, operation misuse, neglect, alterations, normal wear and tear, incorrect voltage or acts of God. This warranty does not cover service calls which involve defective workmanship, damage due to other products while combined use with this product or materials covered by this warranty. Accordingly, diagnosis and repair costs for a service call which involves defective workmanship or materials will be the responsibility of the consumer-owner.

Most work is covered. The defining factor is has the machine malfunctioned (Consolidated Brands is responsible) or has the customer omitted or done something to cause malfunction (customer is responsible).

THE FOLLOWING WORK ARE NOT COVERED UNDER WARRANTY:

Installation

1. Non-removal of shipping bolts, causing vibration / internal damage.
2. Non-adjustment of feet to level machine, causing vibration / internal damage.
3. Non-removal of exhaust vent plate at the back while using Venting Dry mode, causing excess heat and resulting in damage to internal components.
4. Using incorrect length of venting i.e. more than 10 feet unless used with a booster fan.
5. Not conforming to minimum space requirements for built-in installation, causing excess heat and resulting in damage to internal components.
6. Installation in a corrosive environment.
7. Incorrect water pressure i.e below 7.25 psi or above 145 psi
8. Incorrect water inlet hose installation (use only factory supplied hoses with metric threads on the L shaped side to fit water valve)

Maintenance

1. Non-cleaning of coin trap for debris, causing the unit to not drain out water and resulting in drain pump malfunction.
2. Non-cleaning of vent fan & exhaust hose for lint, causing the unit to not dry properly.
3. Improper maintenance (such as, but not limited to, scale build-up, freeze damage, or vent blockage).

Damage

1. Breakage of cosmetic parts e.g., door handle, knob.

Other

1. Accident, abuse or misuse.
2. Using solvents to clean the machine or wash clothes, causing damage.
3. Misapplication of this product e.g., use in a non household/commercial environment.
4. Any other cause not due to defects in materials or workmanship.
5. Problems or damage due to fires, flooding, electrical surges, freezing or any acts of God.
6. Any damage caused by poor water quality.
7. Operating the appliance with anything other than potable water at all times.
8. Force majeure.

Warranty Limitations

1. If a unit is located more than 25 miles away, there will be a trip charge.
2. If a unit is in a remote area more than 75 miles away, the machine should be taken to the technician's workshop.
3. All repairs or replacements are warranted only for the remainder of the original warranty period.
4. If a return or replacement is required, allow 3-4 weeks to process.
5. Replacement units will be delivered with curbside delivery only.
6. We may require the return of products or parts to our warranty department for which the shipping charges are to be pre-paid by the consumer / owner.
7. Charges may be incurred if warranty coverage is not applicable.
8. Service would be provided from Monday to Friday between normal business hours.

All rights reserved. Manual subject to change without notice.

California Proposition 65

WARNING: This product contains chemical known to the State of California to cause cancer and birth defects or other reproductive harm.

TECHNICAL DATA

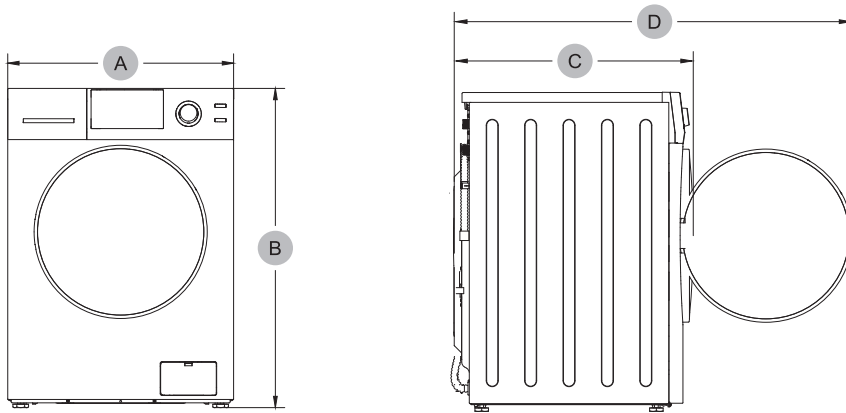

Type		Front loading washing machine
Model		835
Dimensions (inches / mm)	A. Width	23.6 / 600
	B. Height-overall	33.5 / 850
	C. Depth	24 / 615
	D. Depth with door open	41.3 / 1,035
Rated voltage		110-120V / 60Hz 10A
Water pressure (psi / Mpa)		7.25 - 145 / 0.05 - 1.00
Wash capacity (lb / kg)		18 / 8.0
Net weight (lb / kg)		183 / 83
Spin revolution (rpm)		Max. 1,400
Power consumption (W)	Washing	150
	Spin	500
	Wash heater	1,000
Inlet and Drain Hose length		6 Feet
Power cable length		6 Feet



Intertek
4007606

Electrical Testing Laboratories

US N° 4007606 CANADA

The ETL Listed Mark is the legal equivalent to the UL and CSA Listed Marks

Note: All rights reserved.
Designs, Specifications and Manual subject to change without notice

IMPORTANT SAFETY INSTRUCTIONS

Your safety and that of your children



Your washing machine has been built in compliance with safety regulations, to protect you and all your family.

WARNING – To reduce the risk of fire, electric shock, or injury to persons when using your appliance, follow basic precautions, including the following:

1. Read all instructions before using the appliance.
2. Do not wash articles that have been previously cleaned in, washed in, or spotted with gasoline, other flammable or explosive substances, as they emit vapors that could ignite or explode.
3. Do not allow children to play on or in the appliance. Close supervision of children is necessary when the appliance is used near children.
4. Before the appliance is removed from service or discarded, remove the door.
5. Do not reach into the appliance if the tub or drum is moving.
6. Do not install or store this appliance where it will be exposed to the weather.
7. Do not tamper with controls.
8. Do not repair or replace any part of the appliance or attempt any servicing unless specifically recommended in the user-maintenance instructions or in published user-repair instructions that you understand and have skills to carry out.
9. Do not add gasoline, dry-cleaning solvents, or other flammable or explosive substances to the wash water. These substances give off vapors that could ignite or explode.
10. Under certain conditions, hydrogen gas may be produced in a hot water system that has not been used for 2 weeks or more. **HYDROGEN GAS IS EXPLOSIVE.** If the hot water system has not been used for such a period, before using the washer, turn on all hot water faucets and let the water flow from each for several minutes. This will release any accumulated Hydrogen.
11. Do not use fabric softeners or products to reduce static unless recommended by the manufacturers of the fabric softener product
12. Check the Coin Trap every few months to remove any coins, buttons or similar size objects.

SAVE THESE INSTRUCTIONS

SAFETY

 CAUTION 	The model number and the serial number are on the label affixed to the back of the unit. These numbers are also available on the front of the cabinet behind the door.
RISK OF ELECTRIC SHOCK DO NOT OPEN	You should note the model and serial numbers of this unit in the space provided. Retain this booklet as a permanent record of your purchase to aid in identification in the event of theft.
CAUTION: TO REDUCE THE RISK OF ELECTRIC SHOCK, DO NOT REMOVE COVER (OR BACK). NO USER SERVICEABLE PARTS INSIDE. REFER SERVICING TO QUALIFIED SERVICE PROFESSIONALS.	MODEL# _____ SERIAL# _____

HELPFUL HINTS

1. Your Washer spins at a high 1200 rpm spin speed, which will extract more water especially from absorbent fabrics and reduce the degree of dampness as This will cut down on your drying time.
2. **FABRIC SOFTENER:** After the wash cycle, the clothes can get stuck to the sides of the drum. USING LIQUID FABRIC SOFTENER WILL CAUSE THE CLOTHES TO UNSTICK IMMEDIATELY AND REDUCE WRINKLES.

PRE-INSTALLATION

1. The unit must be installed on a strong leveled surface in a protected, dry and well-ventilated area, with a power and water supply of sufficient capacity and a sufficient outlet in close proximity.
2. Installation on Carpet or Wood increases vibrations.
 - Carpets – place on light carpet only.
 - Wood – brace floor with screws and place additional sheets of plywood before installation.
3. This unit's installation and grounding should be done in accordance with local codes by a qualified installer. "Installation Instructions" are included in this manual for the Installer's reference.
4. The unit should be plugged into a properly grounded three (3) prong electrical outlet of 110V/60Hz with minimum 15 Amps, It should not be controlled by a wall switch or pull cord which might be turned off accidentally.

DIAGRAM OF THE FULLY AUTOMATIC WASHER

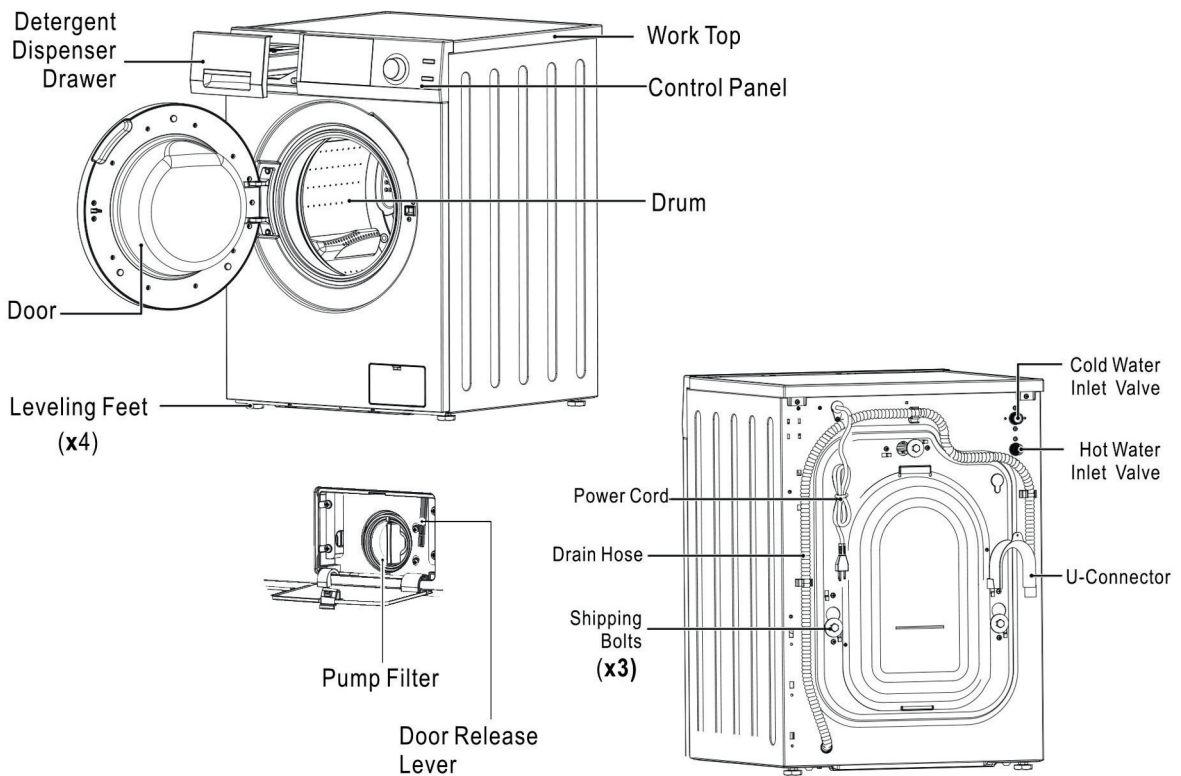

Factory supplied accessories



Cold/Hot water hoses

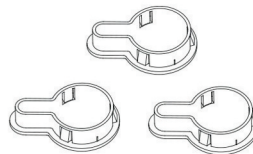

Blanking Caps - 3
(To cover shipping bolts hole)

NOTE

- Contact Customer Service if any accessories are missing.
- For your safety and for extended product life, use only authorized components. The manufacturer is not responsible for product malfunction or accidents caused by the use of separately purchased unauthorized components or parts.
- The images in this guide may be different from the actual components and accessories, and are subject to change by the manufacturer without prior notice for product improvement purposes.

INSTALLATION INSTRUCTIONS

Handling

Please handle the machine carefully and use appropriate means while lifting and moving the machine so that it does not get damaged. Do not drag the machine to your floor and, or, to the machine. Do not hold on to protruding parts when lifting

Disposing of the packing

The shipping package has protected your new washing machine on its way to your home. All packaging materials are non-polluting and recyclable. Please contribute to a better environment by disposing of packing material in an environmentally conscious manner.

 **DANGER** 

Keep children away from the shipping carton and packing components. Danger suffocation from plastic foil and folding cartons.

Disposing of your old appliance

Old Appliances are not worthless trash! Valuable raw material can be recycled from old appliances. To prevent children from locking themselves in the appliances, disable the door locking or remove the door.

Factory - supplied Equipment

Inside the drum there is a packet of accessory parts supplied with your washer. Check that all the accessory parts supplied for your model are there. If any parts are missing contact your dealer.

Any residual moisture inside the drum is due to the final testing which every washing machine undergoes before leaving the factory.

Installation area

 **DANGER** 

Appliance stability is very important otherwise washing machine could “wander” during the spin cycles.

The installation area must be solid and even. Soft floor surfaces such as carpets or surfaces with foam backing are not suitable.

 **DANGER** 

Do not install the washing machine outdoor or in an area exposed to freezing condition. frozen hoses can tear / burst.

If the washing machine is located in a room which will be exposed to temperatures below freezing point, or if it is located in a cabin that is being shutdown for the winter, any residual water in the pump or water inlet hoses must be drained.

Removing the shipping rods

 **CAUTION** 

The shipping rods must be removed before using the appliance for the first time and must be retained for any future transport. (e.g when moving)

UNPACKING, LEVELING & POSITIONING

Remove the packing and check that the Super Washer is undamaged. If you have any doubt, do not use the Super Washer and call Customer Service. Keep all packing parts (plastic bag, foam rubber, screws, etc.) out of the reach of children since they could be dangerous.

Important: The inside of the Super Washer consists of a free floating drum that is affixed with shipping bolts at the back of the cabinet during transport (Fig.1). The power cord can be accessed by removing the shipping bolts (Fig. 2 & 3). Close the holes left open by the bolts with the caps provided (Fig. 4).

It is important for the machine to be perfectly level. For this reason, the machine is fitted with adjustable feet used for leveling the machine before use (Fig. 5).

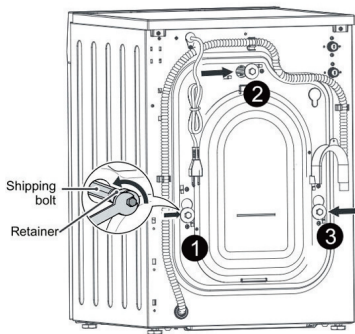

Fig. 1

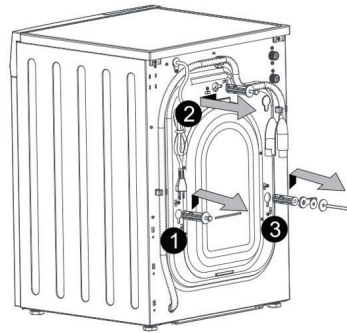

Fig. 2

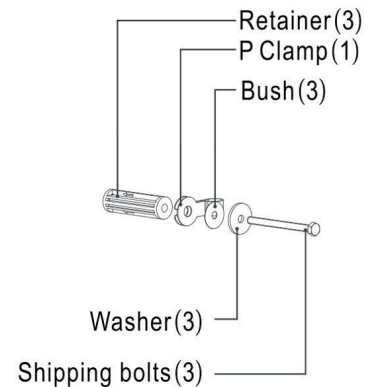

Fig. 3

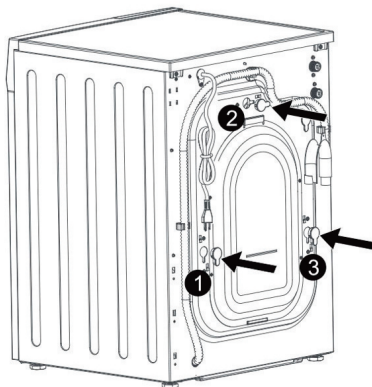

Fig. 4

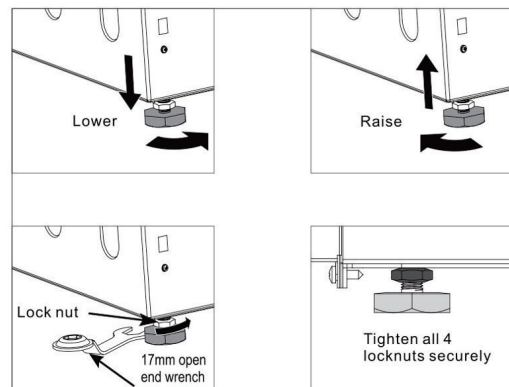

Fig. 5

NOTE

- Save the bolt assemblies for future use. To prevent damage to internal components, DO NOT transport the washer without reinstalling the shipping bolts.
- Failure to remove shipping bolts and retainers may cause severe vibration and noise, which can lead to permanent damage to the appliance.
- The cord is secured to the back of the combo by a clamp with a shipping bolt to help prevent operation with shipping bolts in place.

ELECTRICAL

CONNECTION

Connect the plug to a power outlet - 240V/50Hz with minimum 16 Amps. Make sure that the voltage and frequency available correspond with those stated on the serial number plate located on the machine. Do not use adaptors or extension cords since they could result in overheating and burn out.

POWER SUPPLY

This Super Washer must be connected to an individual circuit identical to the one specified on the rating plate of the loading port protected by fuses or circuit breaker conforming to local codes.

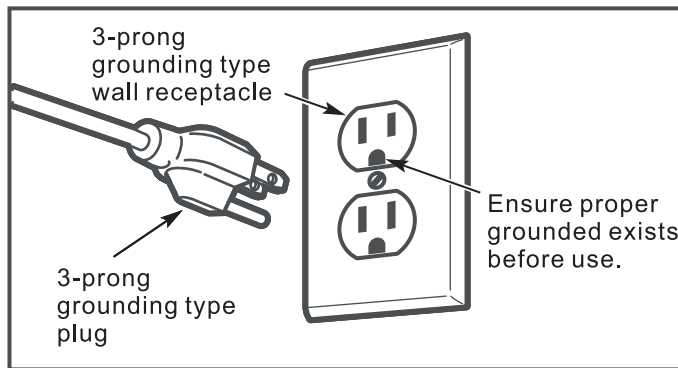

GROUNDING

This appliance must be grounded. In the event of malfunction or breakdown, grounding will reduce the risk of electric shock by providing a path of least resistance for electric current. This appliance is equipped with a power cord having an equipment-grounding conductor and a grounding plug. The plug must be plugged into an appropriate outlet that is properly installed and grounded in accordance with all local codes and ordinances.

WARNINGS

- Improper connection of the equipment-grounding conductor can result in a risk of electric shock. Check with a qualified or service representative or personnel if you are in doubt as to whether the appliance is properly grounded.
- Do not modify the plug provided with the appliance: if it will not fit the outlet, have a proper outlet installed by a qualified electrician.

Note: If the electrical power supply does not meet the specifications listed above, please call a licensed electrician.

PLUMBING

CONNECTING TO THE WATER FAUCET

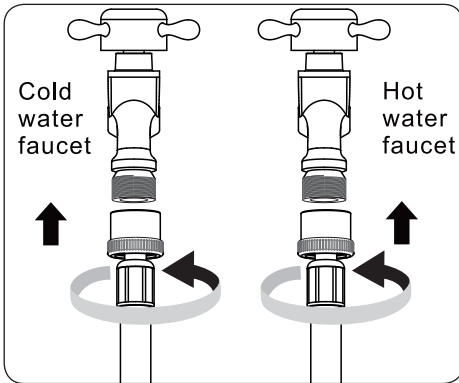

Fig.6

To connect the hoses to the water faucets:

- Connect the straight end of each hose to the cold or hot faucet.
- Turn the fittings by hand until they are tight, and then tighten them by just an additional two-thirds of a turn with a plier. Do not overtighten the fittings. They can be damaged.
- When done, pull the water hoses up and down to check if they are properly connected.

CONNECTING TO THE MACHINE

To connect the hoses to the machine:

- Connect the L-shaped end of each hose to the cold or hot water valve on the rear of machine.
- Open both the faucets, and check if there is a leak.

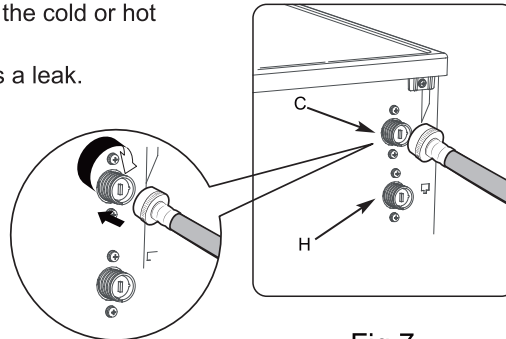

Fig.7

CONNECTING THE DRAIN HOSE

Connect the drain hose to a drain duct (with internal diameter of at least 1.6 inches) or place it for drainage in to a sink or a tub, ensuring that there are no kinks or bends. The free end must be at a height of 24"-40" from the floor. The hose can be held in place using the black plastic clamp on the upper part of the back panel.

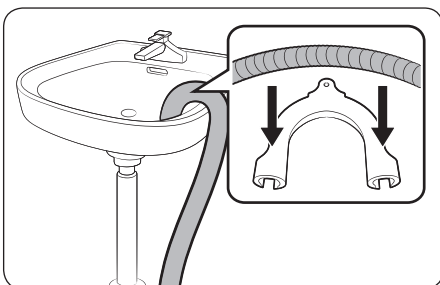

Fig.8

Height difference between the installation location of the washing machine and the drainage point: Minimum 24", and Maximum 40".

- Attach water drain hose to hose guide.
- Hook the hose guide over the side or stand pipe (Fig.8).
- When the water is being drained, check that the water flow out of the hose is adequate.

SPECIAL INSTALLATION REQUIREMENTS

MINIMUM CLEARANCE OTHER THAN ALCOVE OR CLOSET INSTALATION

Minimum clearances to combustibile surfaces: 5 cm clearance both sides and 7.5 cm rear.

BUILT-IN, RECESSED, CLOSET AND ALCOVE INSTALLATION

The Super Washer may be installed in a built-in, recessed area, closet or alcove.

The installation spacing is in centimeters and is the minimum acceptable.

Other installations must use the minimum dimension indicated.

Minimum clearances between dryer cabinet and adjacent walls are: 2" either side and 3" front and rear.

Minimum vertical space from floor to overhead cabinets, etc. is 52" (132cm).

Closet door must be louvered or otherwise ventilated and must contain a minimum of 60 sq. in. of open area equally distributed. If this closet contains both a washer and a dryer, doors must contain a minimum 120 sq. in. of open area equally distributed.

No other fuel-burning appliance shall be installed in the same with closet with dryer.

★ Additional clearances for wall, door and floor molding may be required.

NOTE: If a door is installed that potentially encloses the unit while running, the door must allow for a minimum of 20 square inches of free air movement. There must also be a 1" space in front of the unit to the closed door and 1" from the back of the unit to the wall. Additional spacing should be considered for easy installation, servicing and compliance with applicable local, state, and federal codes.

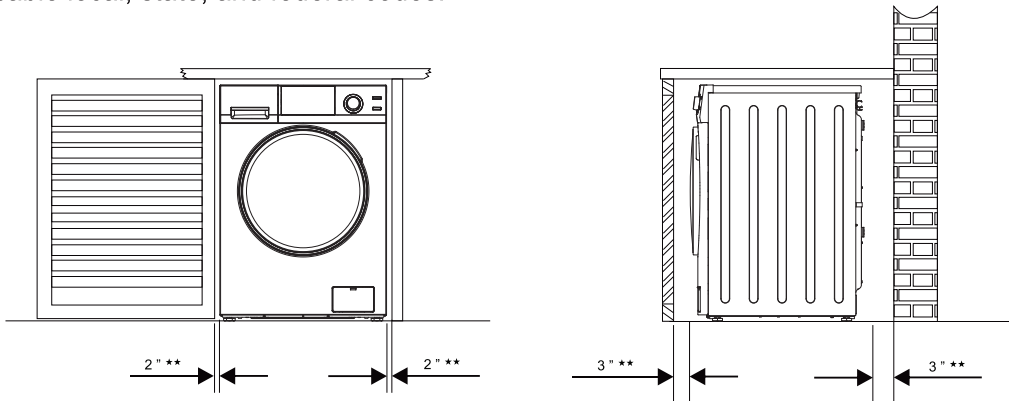
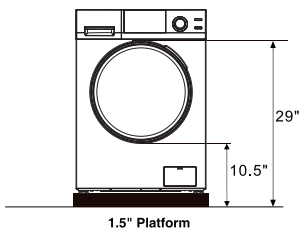

Fig.10

ADA COMPLIANCE



Use 1.5" height platform to make the machine ADA compliant.

PROGRAM SELECTION CHART

1. WASH CYCLES

Wash Programs	Description of Load	Wash Features <small>Water Temp/Spin rpm</small>	Approx Time
1. NORMAL	Mixed Clothes (Shirts, Trousers etc)	Warm / 1200	51 mins
2. Prewash+Heavy	Thick cottons (towels, jeans)	Cold +Hot / 1400	75 mins
3. Heavy	Mixed cottons (t-shirts, jeans)	Hot / 1400	61 mins
4. ECO	Cotton blends, light fabrics	Cold / 800	31 mins
5. Quick 20	Cotton blends, light fabrics	Cold / 1200	20 mins
6. Baby	Light fabrics	Warm / 800	41 mins
7. Delicate	Silk, Polyester etc	Cold / 800	36 mins
8. Wool	Woolens	Cold / 500	36 mins
9. Quiet 60	Mixed cottons	Cold / 800	31 mins
10. Sanitize 165	Bed Sheets etc	Hot / 1200	69 mins
11.Allergen 131	Mixed Cottons	Hot / 1200	59 mins
12. PET Cycle	Mixed Cottons	Cold / 1200	46 mins

2. OTHER CYCLES:

Spin only- 12 minutes Spin cycle at Max. 1,000 RPM.

Self clean - 40 minutes cycle at 90° to clean the inner drum and tub of the machine.

Rinse/Spin - 15 minutes rinse cycle and a spin cycle.

Winterize - 2 minutes cycle to winterize your appliance.

PET Cycle - For cleaning pet hair - Please see important instructions on page 15.

! The total working time will vary with the laundry size, water pressure, water temperature and ambient temperature etc..

PET Cycle

Before loading clothes and sheets into the appliance, remove as much pet hair as possible in order to prevent buildup and clogging of the drain pump. Wipe the surface of clothes and sheets with a lint roller or a damp rubber glove to easily remove pet hair.

After the end of the wash cycle, run a quick wash cycle without clothes. After the cycle ends, wipe down the drum with a damp cloth to collect any pet hair on the drum surface.

OPERATING INSTRUCTIONS

1. Make sure the Washer is turned off. (Power Indicator light should be off).
2. Separate clothes by type, color and degree of soiling.
3. For small items such as socks, children's garments and small towels please use a **Washing Net Bag**.
4. Load clothes of the selected type loosely into the drum.
5. Close the Washer door. You will hear a click when it is correctly closed.

Use High Efficiency (HE) detergent about 1 table spoon.
Add detergent to Dispenser A.

You can add fabric softener and pre-wash detergent as shown in the diagram to compartment B & C.

Detergent Dispenser

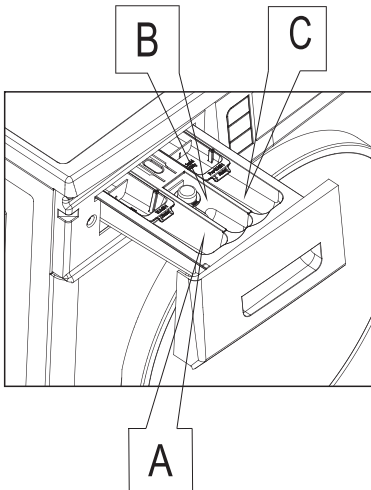

Dispenser A:
Detergent for main wash

Dispenser B:
Fabric Softener

Dispenser C:
Detergent for pre-wash

**The blue cups are only for liquid detergent.
Please do not add powder in these cups.**

Note : concentrated fabric softener must be diluted with a little water before being poured into the dispenser
(This prevents the over flow siphon from getting blocked)

Add detergent in Dispenser C, only for Pre-Wash cycle.

WINTERIZING

How to winterize for cold weather

- 1) Pour 2 cups of RV type Antifreeze in soap dispenser.
- 2) Select WINTERIZE cycle on knob and press START. Machine will Rinse & Spin.
- 3) Open coin trap once cycle is finished and drain out remaining water.
- 4) Shut off water at both faucets and disconnect water inlet hoses from faucets and drain

Control Panel

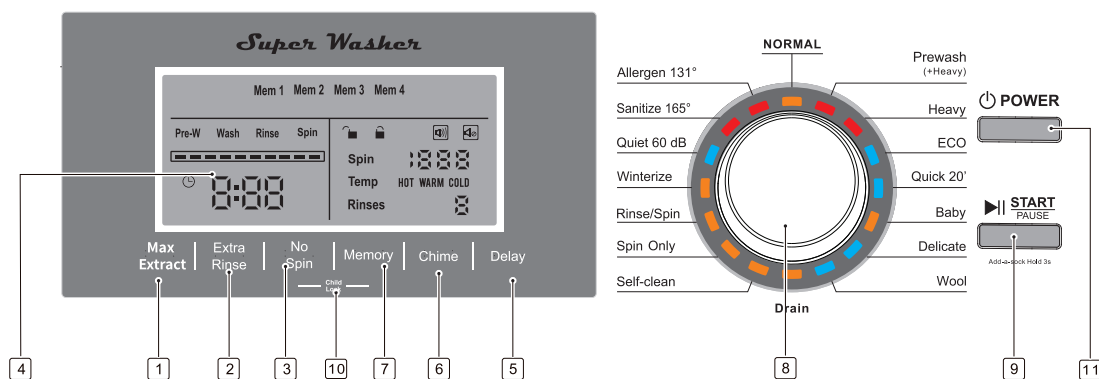

Buttons Introduction

1	Max Extract	To extend the duration of final spin cycle by 30%.
2	Extra Rinse	Press this selection button to add one more rinse cycle to the selected washing program.
3	No Spin	Press this selection button to add a special function to the selected washing program. This function will keep the laundry in the rinse water after the last rinse cycle is finished. Press this button again, it will drain out the water, and step into last spin cycle.
4	Color LED Display	To display the selected program, such as the water selection, spin speed, remaining time, rinse times, water level and error messages.
5	Delay Start button	Press this button to select the delay time from 1 to 24 hours in one hour increments before the wash cycle started. If a change is to be made after the delay start time is set, turn the dial to other point, then select your desired program again.
6	Chime button	Press this button to turn on, or turn off the chime before you start the washing cycle.
7	Memory button	Press this button to select one of the four positions, then select the additional options for your favorite washing cycles, then press Start/Pause button to run this program, and this program will be memorized. If you want to run the memorized program later, press this button to select one of them, then press Start/Pause button. Press Start/Pause button to cancel the Memory operation.
8	Program Dial	Turn dial to point to one of the 16 programs depending on the load to turn the unit on.
9	Start/Pause button	Press this button to start or interrupt the selected wash program, or to view the program during a cycle.
10	Child Lock	In order to deactivate function to the controls, to prevent altering cycle, press and hold No spin and Memory buttons for 5 seconds
11	Power	Press this button to turn the machine on. Or hold down this button to turn it off.

Display Panel Symbols

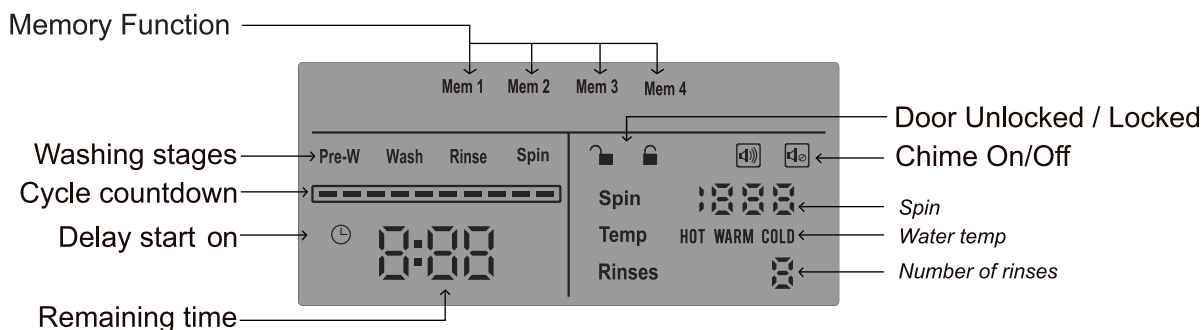

How to Run Wash cycle

1. Press POWER button
2. Press START

Default cycle is DAILY - If required, you can change to desired washing cycle based on type of clothes by rotating the Program Dial knob.

How to stop the wash cycle

- The wash program can be stopped at any time.
- PRESS START/PAUSE, rotate the knob to another program to cancel the current selected program.
- PRESS POWER button for 3 seconds to turn off the machine

How to turn on the display in energy saving mode

- Machine display gets turned off automatically during operations to save energy.
- Press any button to turn on display during this energy saving mode

Add-a-sock Feature

The wash program can be stopped at any time to add forgotten items to the laundry.

- PRESS START/PAUSE for 5 seconds.
- Door will open after draining water so that it does not overflow.
- Load clothes. Close door.
- Press START The cycle will continue from the point it stopped

Understanding the door lock function

Pressing the start button  will lock the door  → . The wash cycle will start and will continue until the whole program is completed. The door will be locked and cannot be opened until the wash cycle ends. Please do not try to force the door open. **Breakage of the door handle is not covered by warranty.**

USEFUL TIPS

Denim Alert:





























Some overalls have straps with hooks that can damage the drum of your washing machine or other garments during the wash. To minimize the risk, place hooks in the pocket and fasten with safety pins.

Vacations: unplug the appliance:

It is recommended that you should unplug the machine from the socket and turn off the water supply. Leave the door ajar to allow air circulation to the drum and the door gasket area. This will prevent unpleasant odors.

UNDERSTANDING FABRIC CARE LABELS

The symbols on labels of your garments will help you in choosing the suitable wash program, the right temperature, wash cycles, and ironing methods. Please review the chart below.

 Energetic wash  Delicate wash	 Max. wash temperature 95°C	 Max. wash temperature 60°C	 Max. wash temperature 40°C	 Max. wash temperature 30°C	 Hand wash	 DO NOT wash at all
 Bleaching	 Bleach in cold water			 DO NOT bleach		
 Ironing	 Hot iron max. 200°C	 Warm iron max. 150°C	 Lukewarm iron max. 110°C	 DO NOT iron		
 Dry cleaning	 Dry cleaning in all solvents	 Dry cleaning in perchlorethylene, petrol, pure alcohol, R 111 & R 113	 Dry cleaning in petrol, pure alcohol and R 113	 DO NOT dry clean		
 Drying	 Flat	 On the line	 On clothes hanger	 High temperature  Low temperature Tumble dry	 DO NOT tumble dry	

MAINTENANCE

Your Washer has been designed to operate with easy maintenance.
Follow these simple maintenance procedures to obtain optimum performance:

1. Ensure that your machine was installed according to the correct installation procedures detailed in this Manual.
2. Do not use solvents either to clean the machine or to wash clothes.
3. Keep the inside of the detergent dispenser clean.

Cleaning the coin trap

- Switch off the Washer, allow the water to cool down.
- Open the service flap by using a finger. (bottom right corner) (Fig.13)
- Turn the pump filter open to the left. (Fig.14)
- Remove foreign objects/fluff from inside and clean the interior. (Fig.15)
- The pump impeller wheel located behind the water filter, must be able to rotate.
Remove detergent residue and fluff from the pump cover thread and pump housing.
- Insert the coin-trap cover and screw tight, close the service flap. (Fig.16)

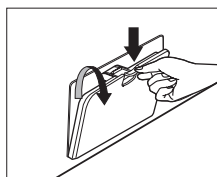

Fig.13

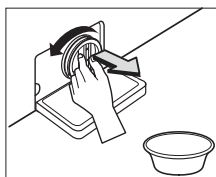

Fig.14

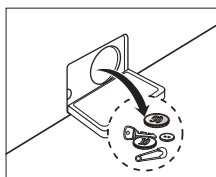

Fig.15

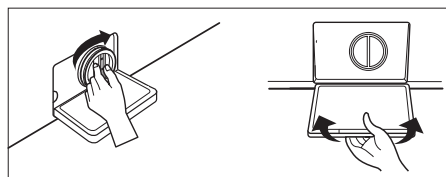

Fig.16

Cleaning the Detergent drawers and Recess

- Press release lever on the inside of the drawer and pull it out. (Fig.16)
- Remove the cap from the Fabric Softener compartment.
- Clean the drawer recess with a bristle brush. (Fig.17, Fig.18)
- Reinsert the cap (Pushing it firmly into place).
- Push the drawer back into place.
- Run a rinse program without any laundry in the drum.

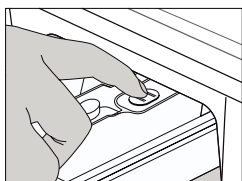

Fig.16

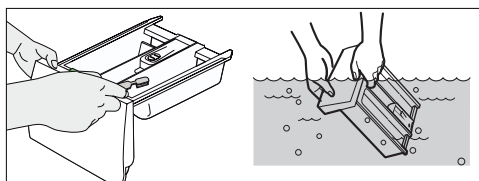

Fig.17

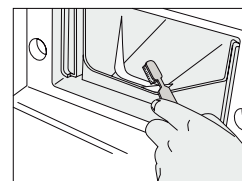

Fig.18

Cleaning the water inlet filter

- If water is very hard or contains traces of lime deposit, the water inlet filter may become clogged. It is therefore a good idea to clean it from time to time.

- Turn off the water tap. (Fig.19)
- Unscrew the water inlet hose. (Fig.20)
- Clean the filter using a hard bristle brush under the running water. (Fig.21)
- **Insert the filter into the valve** and tighten up the inlet hose. (Fig.22)

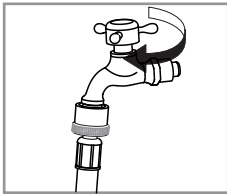

Fig.19

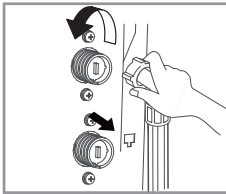

Fig.20

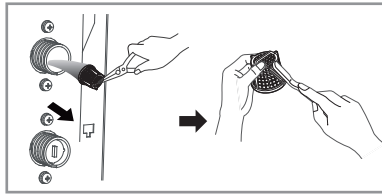

Fig.21

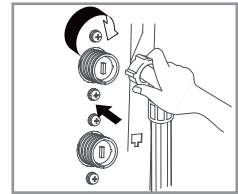

Fig.22

Cleaning the drum

If you live in a hard water area, limescale may build up continuously in places where it cannot be seen and thus not easily. Over time the build up of scale clogs appliances, and if it is not kept in check these may have to be replaced.

Although the washing drum is made of Stainless steel, specks of rust can be caused by small metal articles (paper clips, safety pins) which have been left in the drum.

- The washing drum should be cleaned from time to time.
- If you use descaling agents, dyes or bleaches, make sure they are suitable for washing machine use.
- Descaler may contain chemicals that may damage part of your washing machine.
- Remove any spots with a stainless steel cleaning agent.
- Never use steel wool.

Cleaning the machine

1.Exterior

Proper care of your washer can extend its life.

- The outside of the machine can be cleaned with warm water and a neutral non abrasive household detergent.
- Immediately wipe off any spills. Wipe with damp cloth.
- Try not to hit surface with sharp objects.
- Do not use methylated spirits, diluents or similar products.

2.Interior

- Dry around the washer door opening, flexible gasket and door glass.
- Run washer through a complete cycle using hot water.
- Repeat process if necessary.



To remove hard water deposits, use only cleaners labelled washer safe.

Clean Door gasket

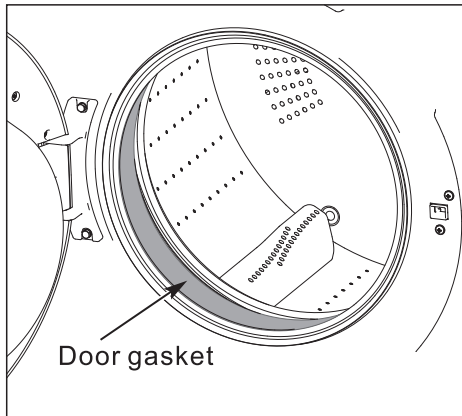

Clean the door gasket once a month to prevent buildup of dirt in the door gasket.

- Open the door, and then empty the drum.
- Combine 3/4 cups of liquid chlorine bleach and 3~4 L of warm tap water.
- Turn over the rubber door gasket.
- Wearing rubber gloves, use a soft, clean cloth dipped in the water and bleach solution to clean the gasket.
- Let stand 5 minutes, and then wipe up and dry well.
- Put the rubber gasket back into position.

⚠ CAUTION

1. Clean the door gasket with undiluted liquid chlorine bleach may cause the door gasket and machine to malfunction. Dilute the bleach by adding it to water before using it.
2. Use bleach carefully and be sure to follow the bleach manufacturer's use and care instructions.

Emergency Release, e.g the power failure occurs

The program continues running if the power is restored. If the laundry is still to be unload, the door can be opened as described below:

- Open the service flap.
- Drain the remaining water.
- Pull down the emergency release lever with a tool and release.
- Door can then be opened.
- Close the service flap.

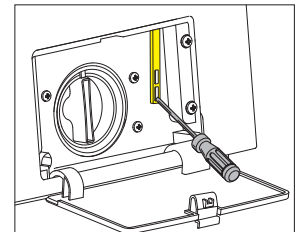

The dangers of freezing

If the machine is exposed to temperatures below 0°C, certain precautions should be taken.

- Turn off the water tap.
- Unscrew the inlet hose.
- Unhook the drain hose from the sink.
- Pull forward the drain hose and the inlet hose in a bowl placed on the floor, and let the water drain out.
- Screw the water inlet hose back on and reposition the drain hose.

When you intend to start the machine up again, make sure that the room temperature is above 0°C.

STAIN REMOVAL CHART

Blood

Rinse or soak fresh stain in cold water. Work detergent into any remaining stain. Rinse. If stain persists, put a few drops of ammonia on stain and repeat detergent treatment. Rinse. If necessary bleach.

Burn Marks

Rinse or soak in cold water. Work detergent into stain. Rinse. Bleach, if necessary. Stain may be impossible to remove

Candle Wax

Scrape off excess. Place stain between clean white blotters or several layers of facial tissues. Press with warm iron. Sponge with cleaning fluid. If dye spot remains, bleach.

Chewing Gum

Rub with ice to harden. Scrape off excess with dull blade. Sponge with cleaning fluid.

Chocolate or Cocoa

Soak 15 minutes in cold water. Rub detergent paste into stain, then rinse thoroughly. Launder in hottest water safe for fabric. If colored stain remains, sponge with hydrogen peroxide, rinse and launder.

Coffee or Tea

Soak fresh stains immediately in cold water. Then use bleach treatment with hottest water safe for fabric.

Cosmetics: eye shadow, lipstick, liquid make-up, mascara, powder, pancake make-up or rouge

Apply undiluted liquid detergent to stain, or dampen stain and rub in soap or detergent paste until thick suds are formed. Work in until stain is gone, rinse well. Repeat if necessary. If color remains, bleach if safe for fabrics.

Cream, Ice Cream or Milk

Sponge stain with cool water or soak stain in cool water for 30 minutes or longer. If stain remains, work detergent on spot then rinse. Bleach if necessary.

Deodorants and Antiperspirants

Wash or sponge stain thoroughly with warm water and detergent; rinse. If stain remains, bleach with hot sudsy water. Launder. You may be able to restore fabric color by sponging with ammonia. Rinse thoroughly.

Dye

Rinse or soak in cold water. Work detergent into stain. Rinse. If necessary, bleach. Stain is not always possible to remove. A commercial color remover may also be used.

Egg or Meat Juice

Rinse in cold water. If stain remains, sprinkle with meat tenderizer, let stand 15-20 minutes. If stain still remains, sponge with cleaning fluid or diluted bleach. Launder in hot water. The use of hot water first may set stain.

Fabric Softener Stain

Rub with bar soap until stain has lightened. Rinse thoroughly. Launder. Rubbing alcohol is sometimes effective in the color of the garment can take it. Launder. If desired, dry cleaning can be used.

Felt tip pen

Spray spot with cleaners suitable to this purpose. Sponge stain thoroughly. Rinse with cold water. Reapply cleaner if necessary .

Fruit, Wine

Soak fresh stains immediately with cool water. Then use bleach treatment with hottest water safe for fabrics. Launder.

Grass

Work detergent into stain. Sponge with denatured alcohol. Bleach, if necessary.

Grease or Oil

Scrape away excess. Rub detergent paste or a general purpose liquid household cleaner into stain, rinse with hot water. If stain remains, sponge thoroughly with a grease solvent. Dry. Repeat if necessary. To remove yellow stain, use a chlorine or oxygen bleach.

Ink

Some ball-point inks are set by water. First test a scrap of cloth. Sponge stain repeatedly with acetone, amyl acetate or rubbing alcohol. Hair spray is effective. Launder. Bleach if necessary. Use amyl acetate on triacetate, arnel, dynel and verel. Use acetone on other fabrics. NOTE: Some inks cannot be removed.

Ketchup

Scrape of excess. Soak in cold water 30 minutes. Pre-treat with a detergent paste. Launder.

Mildew

Brush off surface growth to keep mold spores from spreading. Dip article into solution of ½ cup bleach per 1 gallon of cool sudsy water for 5 to 10 minutes. Rinse well. Launder.

Mud

Let stain dry; then brush well. Rinse repeatedly in cool water until mud comes out. Launder. (Hot soaps suds set a red or yellow clay stain).

Mustard

Soak in hot detergent water for several hours. If stain remains, bleach.

Nail Polish

Treat while fresh, scraping or wiping off as much as possible, before it dries. Place stain face down on white paper towels. Sponge back of stain acetone (nail polish remover) or sponge with denatured alcohol and a few drops of household ammonia. Sponge stain

frequently. Launder with water at temperature suitable for fabric. *Do not use acetone on acetate, arnel, dynel or rayon.*

Paint

Sponge or soak in turpentine or solvent recommended as a thinner on label. Launder.

Perfume

Rinse in cold water. Rub undiluted liquid detergent or a detergent paste into stain. Rinse. If stain remains, bleach.

Perspiration

Wash or sponge stain thoroughly with warm water and detergent paste. If perspiration has changed the color of the fabric, restore it by treating with ammonia or vinegar. Apply ammonia to fresh stains; rinse with water. Apply vinegar to old stains; rinse with water.

Rust and Iron

Apply commercial rust remover, Rinse. Or, if safe for fabric, boil stained article in solution of 4 teaspoons of cream of tartar to 1 pint water.

Shoe Polish

Scrape off as much as possible. Pre-treat with a detergent paste; rinse. If stain persists, sponge with rubbing alcohol (1 part to 2 parts water) or turpentine. Remove turpentine by sponging again with warm detergent solution or with alcohol. Bleach if necessary.

Soft Drinks

Sponge with cold water, some stains are invisible when they have dried, but turn brown when heated and may be impossible to remove.

Tar and Asphalt

Act quickly before stain is dry. Sponge with grease solvent or turpentine. Launder.

Urine

Soak in cool water. If stain is dry, work a detergent paste into the spot then rinse. If necessary, bleach.

TROUBLESHOOTING

In most cases, when your Super Washer fails to work, the problems arising can be easily solved without having to call for a technician. Before calling for assistance, always check these points.

Problem	Solution
Will not start..	<ul style="list-style-type: none"> • Make sure the door is firmly closed. E -1 • Make sure your Washer is plugged in. • Make sure the water source faucets are open. • Make sure to press the Start/Pause Button to start your Washer. • Make sure the Child Lock is not activated. • Before your machine starts to fill, it will make a series of clicking noises to check the door lock and do a quick drain. • Check the fuse or reset the circuit breaker
Has no water or not enough water..	<ul style="list-style-type: none"> • Turn both faucets on fully. E -3 • Make sure the door is tightly closed. • Straighten the water inlet hoses. • Disconnect hoses and clean filters. Hose filter screens may be clogged. • Open and close the door, then press the Start/Pause Button.
Vibrates or is too noisy.	<ul style="list-style-type: none"> • Make sure your machine is set on a level surface. If the surface is not level, adjust your machine feet to level the appliance. • Make sure that the shipping bolts are removed. • Make sure your machine is not touching any other object. • Make sure the laundry load is balanced.
Load is too wet at the end of the wash cycle.	<ul style="list-style-type: none"> • Use the High or Extra High spin speed. • Use high efficiency detergent to reduce over-sudsing. E -4 • Load is too small. Very small loads (one or two items) may become unbalanced and not spin out completely.
Leaks water.	<ul style="list-style-type: none"> • Make sure the door is firmly closed. • Make sure all hose connections are tight. • Make sure the end of the drain hose is correctly inserted and secured to the drainage system. • Avoid overloading. • Use Front loading detergent to prevent over-sudsing. E -4
Door locked or will not open.	<ul style="list-style-type: none"> • Press the Start/Pause Button to stop your machine. • Your machine door will remain locked during the heating portion of the Sanitize Cycle • It may take a few moments for the door lock mechanism to disengage.
Does not drain and/or spin.	<ul style="list-style-type: none"> • Check the fuse or reset the circuit breaker. • Straighten the drain hoses. Eliminate kinked hoses. If there is a drain restriction, call for service. E -2 • Close the door and press the Start/Pause Button. For your safety, your Washer will not tumble or spin unless the door is closed.
Has excessive suds.	<ul style="list-style-type: none"> • Use Front loading detergent to prevent over-sudsing. E -4 • Reduce the detergent amount for soft water, small or lightly soiled loads. • Non Front loading detergent is NOT recommended.
Continuously fills and drains water	<ul style="list-style-type: none"> • Check the drain hose positioned too low. • Check that the inlet hose is not connected at a height more than 100 cm above the floor.

DIAGNOSTIC MENU

Code	Description	Component
E1	Door open	Door Switch
E2	Drain failure	Drain Pump
E3	Water inlet failure	Inlet Valves
E4	Water overflow	Inlet Valves
E5	Motor failure	Motor +Electronic Module
E7	Washing heater failure	Washing heater
E10	Water level failure	Water level sensor
E16	Communication failure between Motor & Module	Communication Cable

Information or Parts:

www.ApplianceDesk.com/Parts

