

# ASSEMBLY INSTRUCTIONS

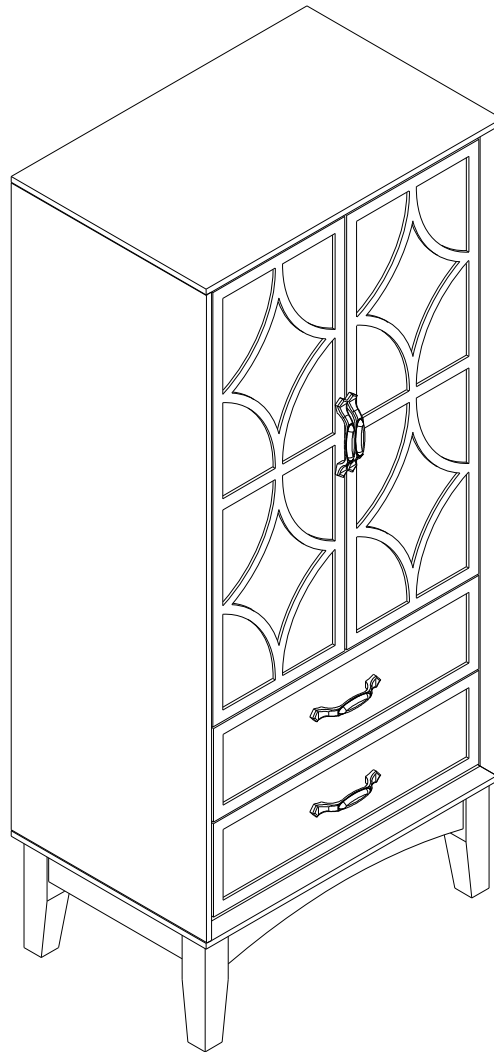

## Notice:

1. Follow the installation instructions. Please confirm all accessories are preset before installation.
2. Do not fully tighten the screws during initial assembly. Fully tighten screws only once all pieces which are correctly assembled.
3. If you encounter any problems during installation, please contact our customer service.
4. Please unbox the item from the side with an open-label and put a carpet on the floor to avoid scratching it.

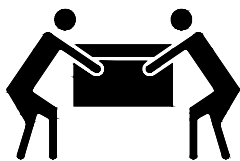

Recommended installers:2

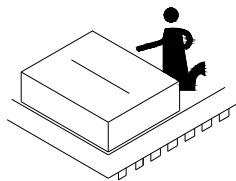

Put a carpet on the floor  
before unpacking

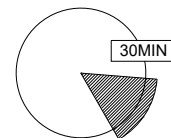

Estimate installation time:  
30minutes





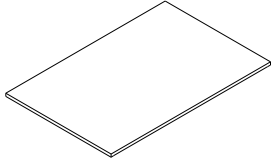
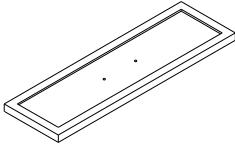
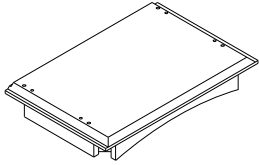
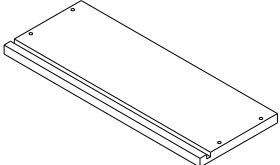
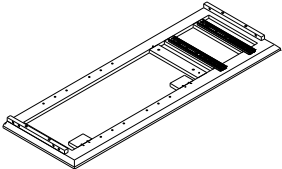
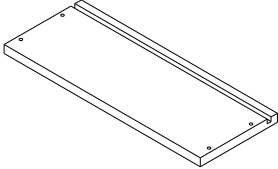
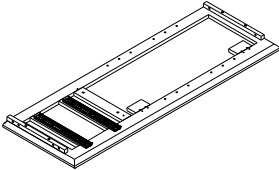
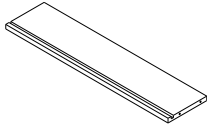
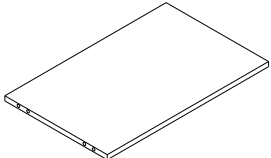
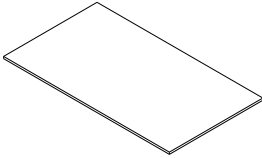
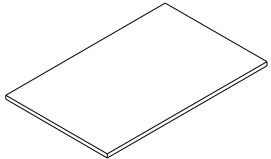
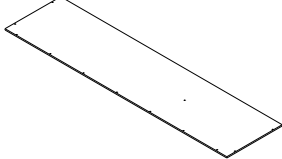
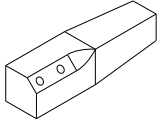
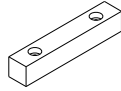
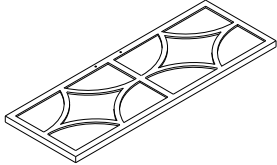





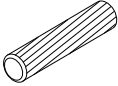
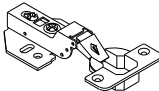
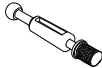

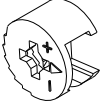

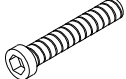
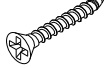
# ASSEMBLY INSTRUCTIONS

## PART LIST

Item no.	Reference Image	Qty	Item no.	Reference Image	Qty
(A)		X1	(I)		X2
(B)		X1	(J)		X2
(C)		X1	(K)		X2
(D)		X1	(L)		X2
(E)		X1	(M)		X2
(F)		X2	(N)		X2
(G)		X4	(O)		X1
(H)		X2			

# ASSEMBLY INSTRUCTIONS

## HARDWARE LIST

Item no.	Reference Image	Qty	Item no.	Reference Image	Qty
1	 Ø8*30mm	X12+1	10		X4
2		X4	11	 Ø3*12mm	X24+2
3		X4	12		X8
4	 Ø1/4"*2"	X8	13	 Ø4*25mm	X2
5	 Ø1/4"*1-1/4"	X8	14	 Ø3*15mm	X24+2
6		X16+1	15	 Ø3.5*30mm	X16+1
7		X16+1	16		X1
8		X4	17		X1
9	 Ø5/32"*3/4"	X8			

# ASSEMBLY INSTRUCTIONS

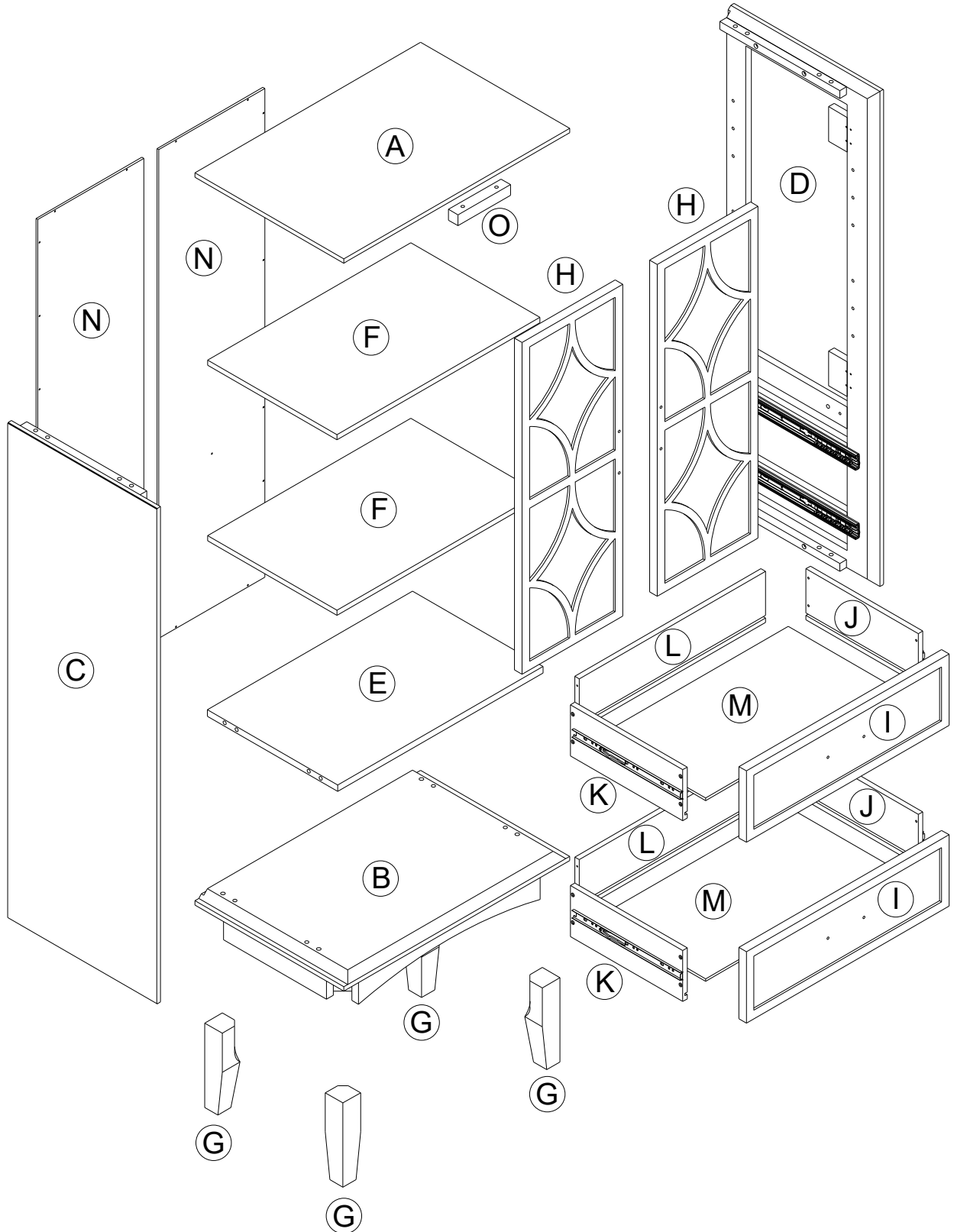

# ASSEMBLY INSTRUCTIONS

1

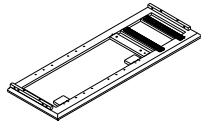

Ⓒ 1PC

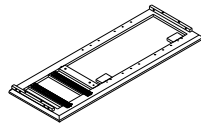

Ⓓ 1PC



② 4PCS

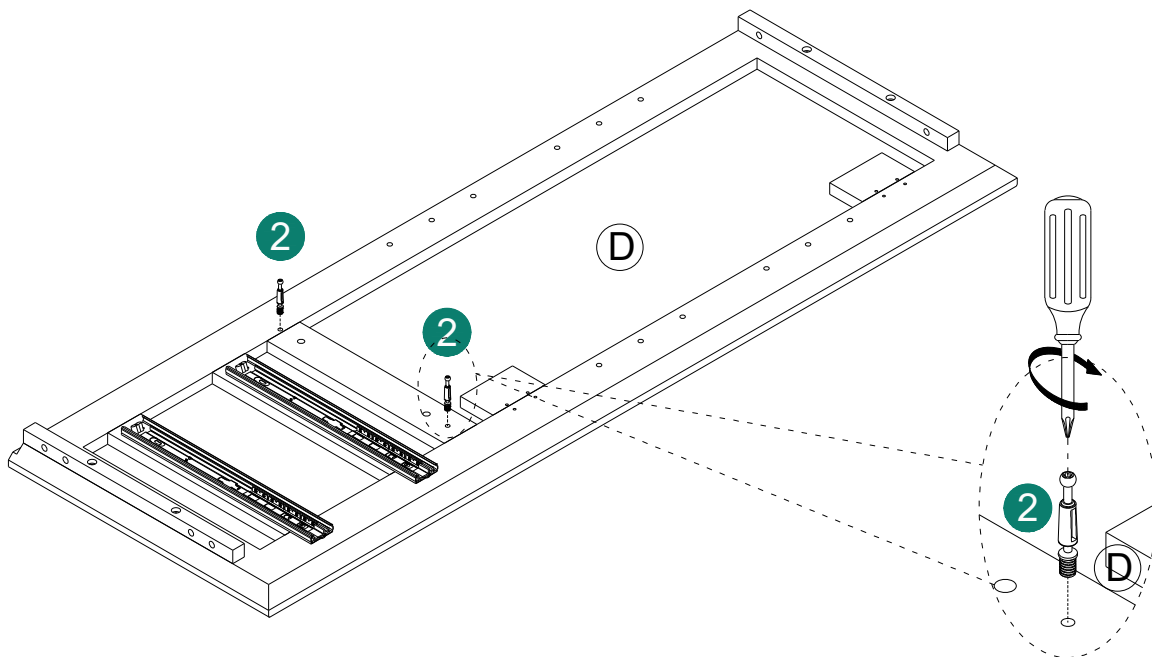
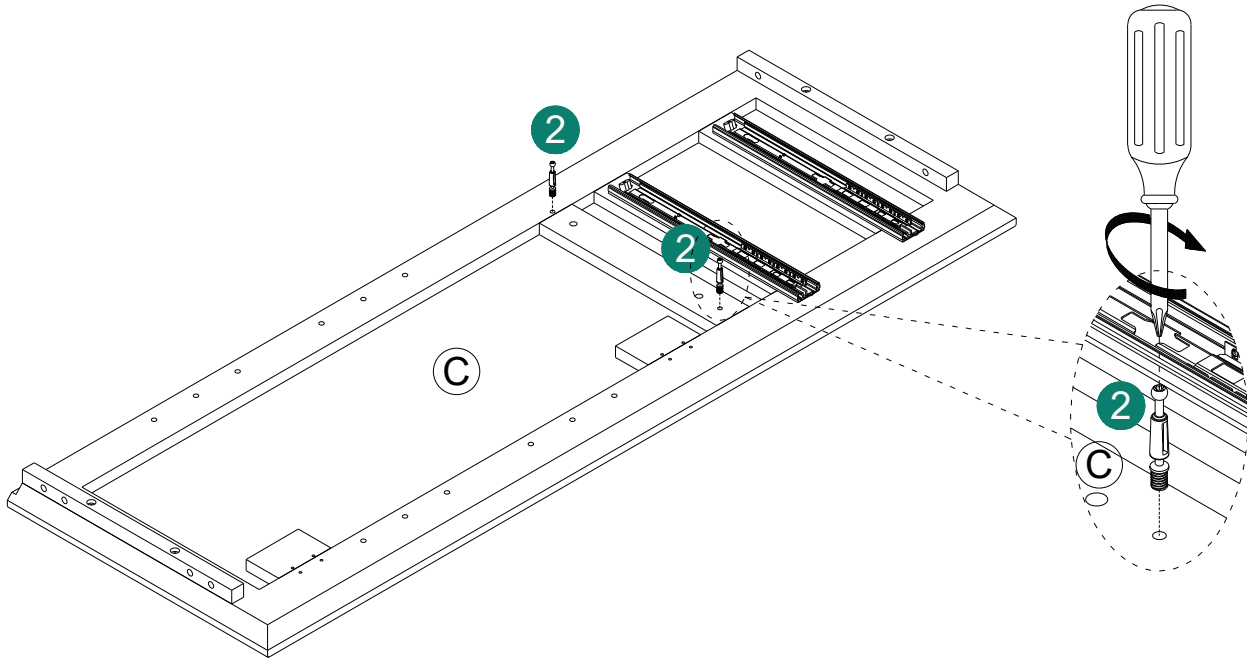

# ASSEMBLY INSTRUCTIONS

2

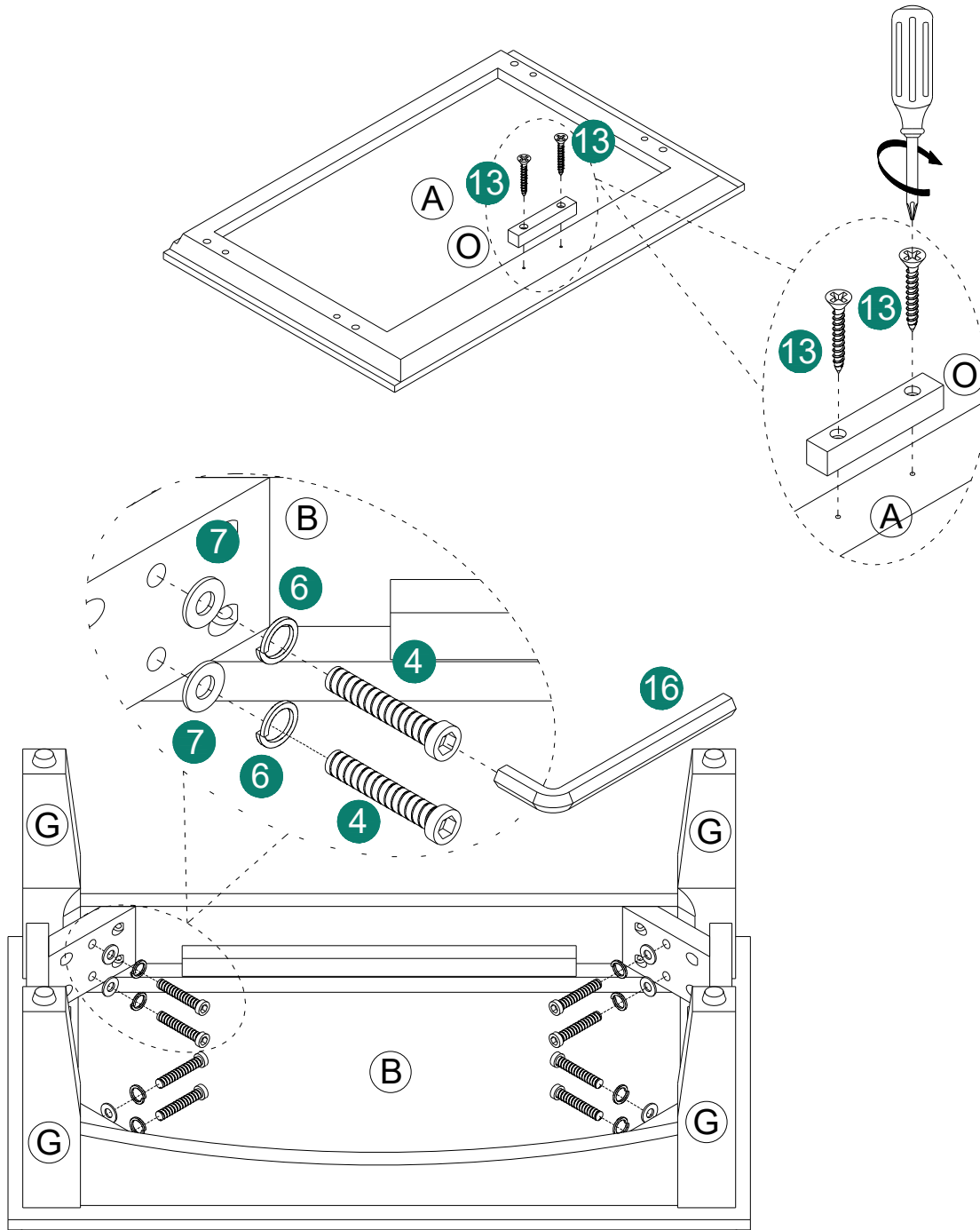
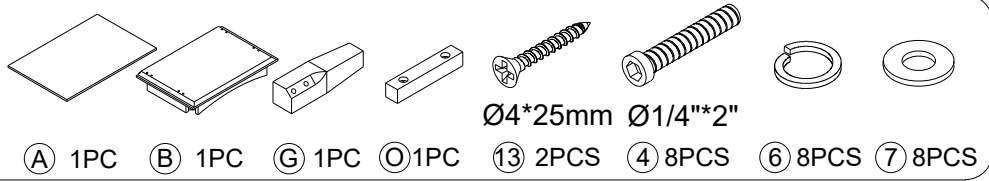

# ASSEMBLY INSTRUCTIONS

3

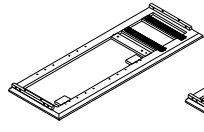

Ⓒ 1PC

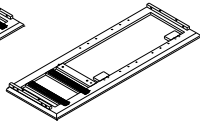

Ⓓ 1PC

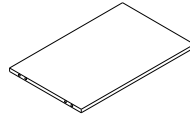

Ⓔ 1PC

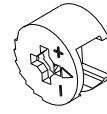

Ⓒ 4PCS

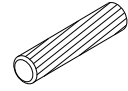

Ⓐ 4PCS

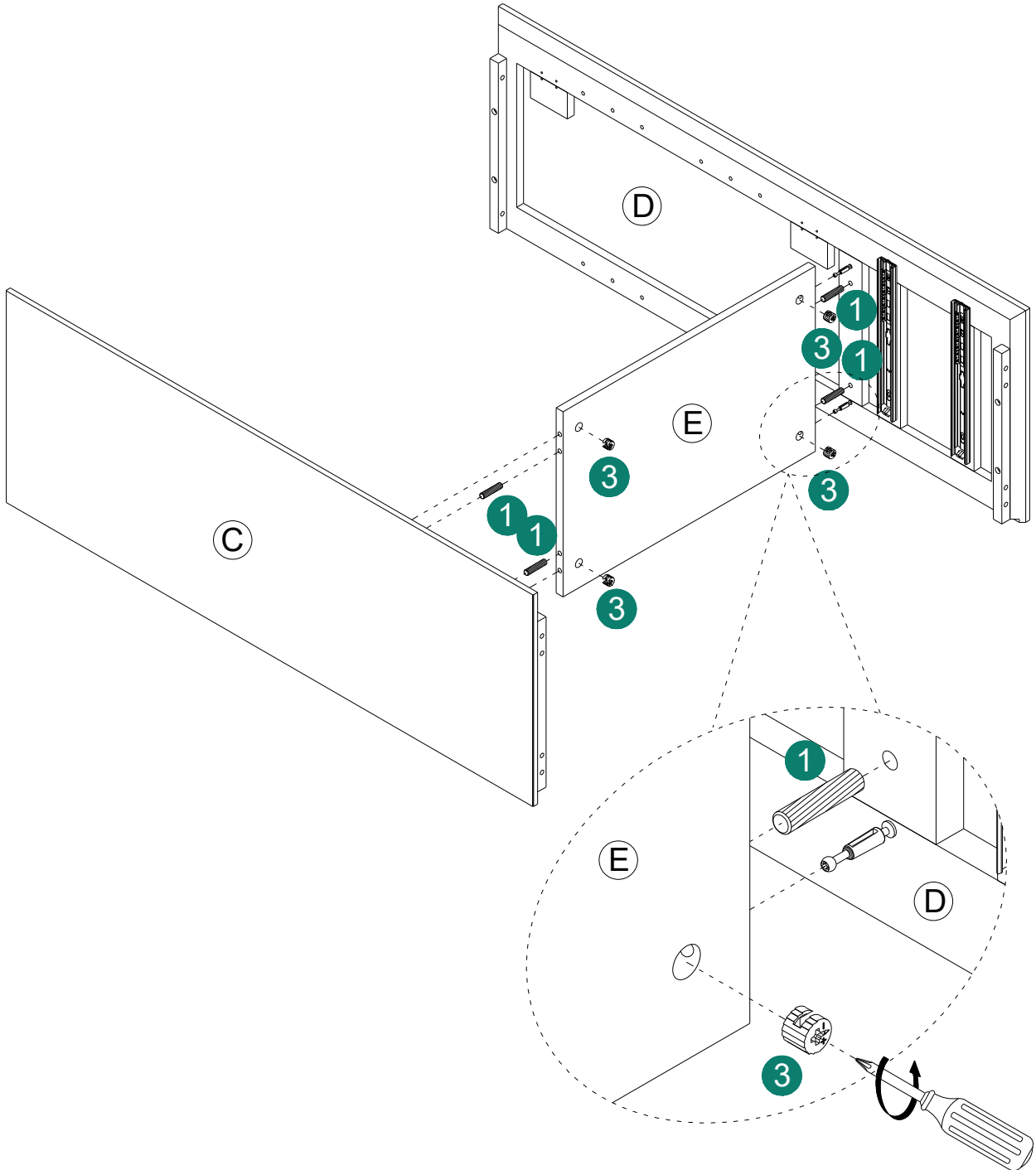

# ASSEMBLY INSTRUCTIONS

4

  
Ø1/4"×1-1/4"  
⑤ 4PCS

  
⑥ 4PCS

  
⑦ 4PCS

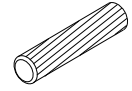
  
① 4PCS

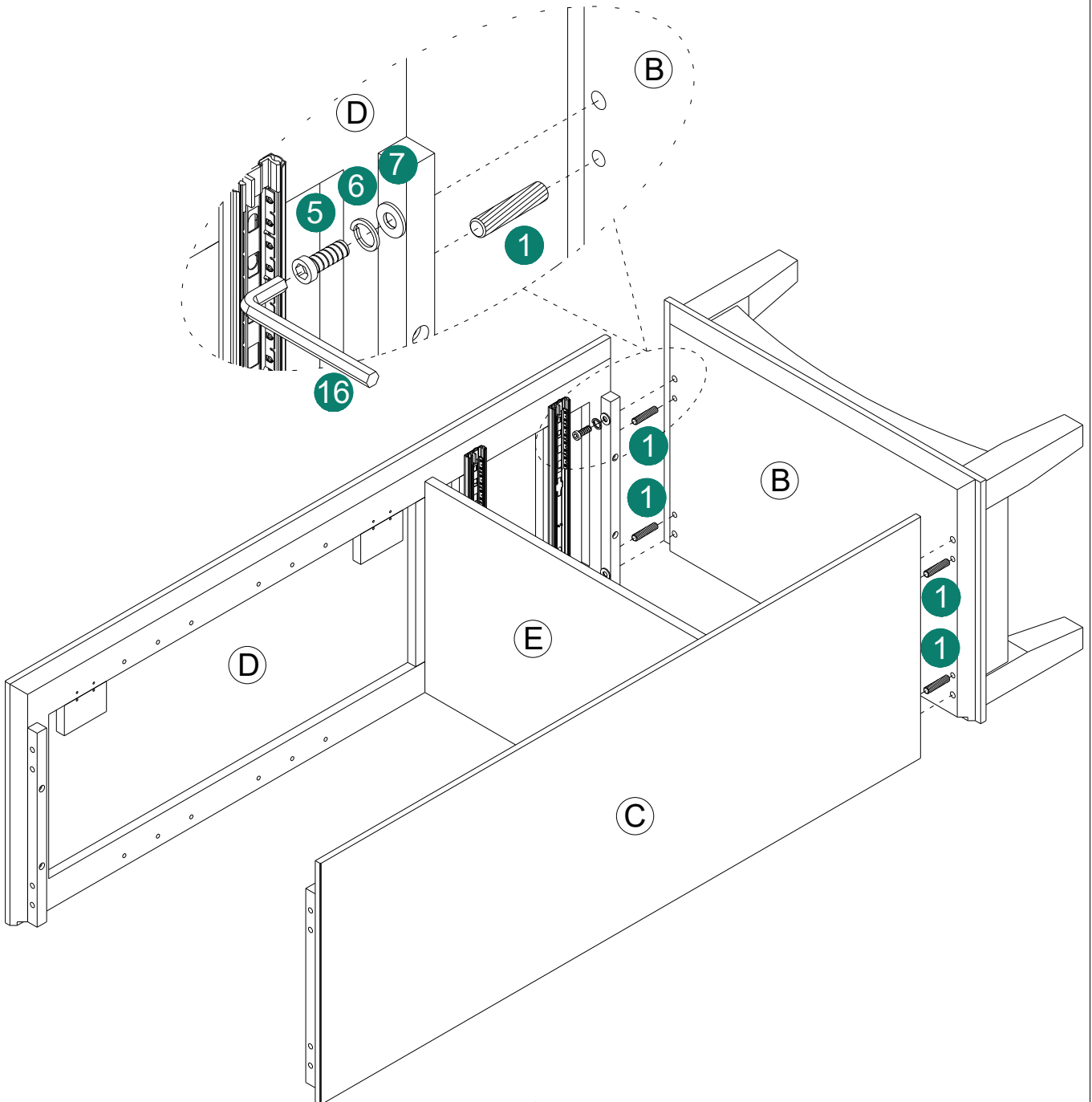

# ASSEMBLY INSTRUCTIONS

5

  
Ø1/4"\*1-1/4"  
⑤ 4PCS

  
⑥ 4PCS

  
⑦ 4PCS

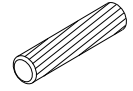
  
① 4PCS

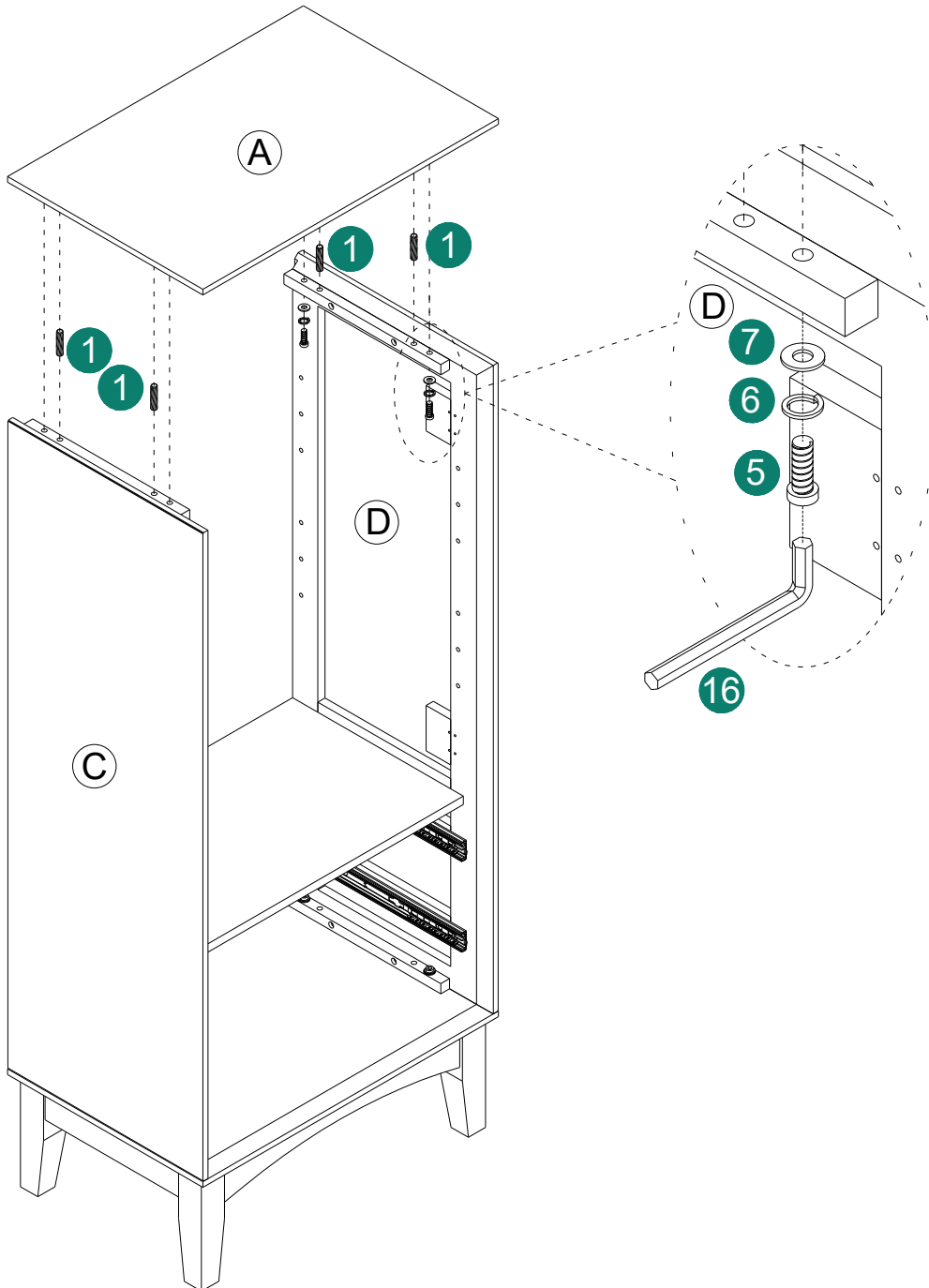



# ASSEMBLY INSTRUCTIONS

7

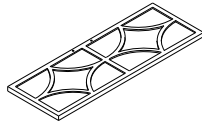

Ⓜ 2PC



Ⓜ 2PCS



Ø5/32"×3/4"

Ⓜ 4PCS

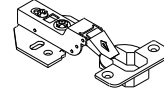

Ⓜ 4PCS

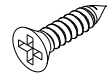

Ⓜ 8PCS

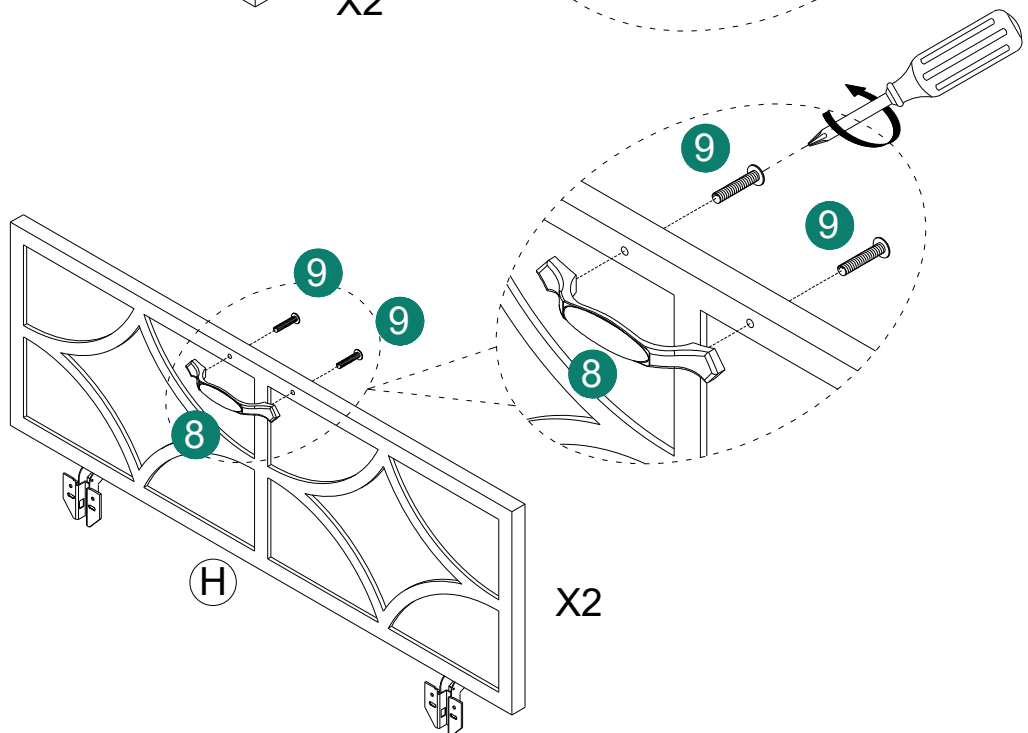
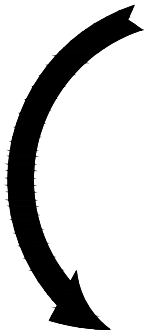
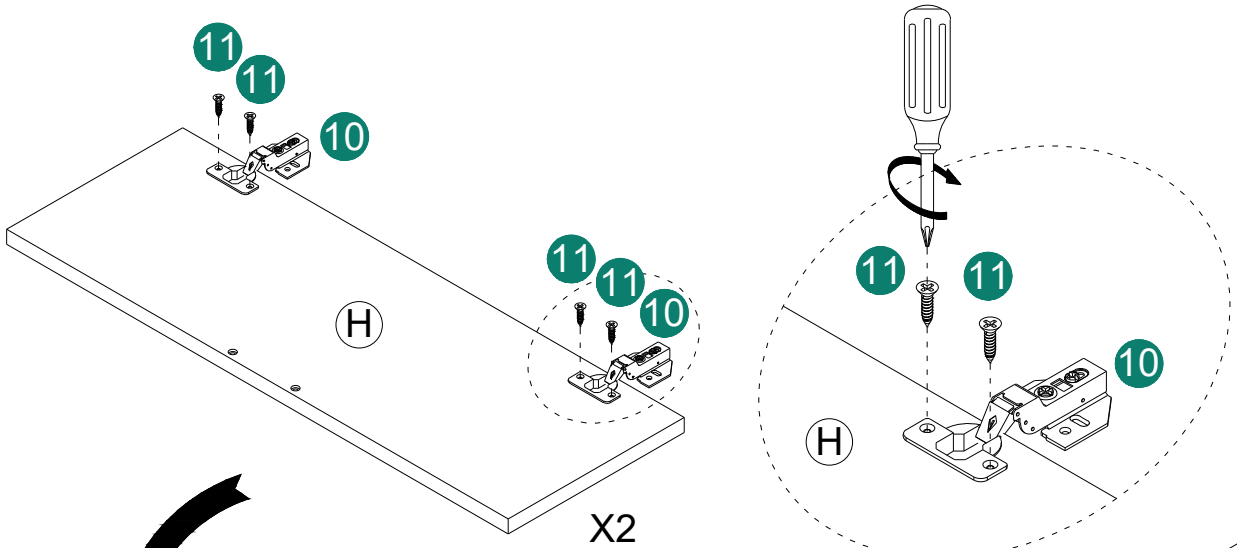

# ASSEMBLY INSTRUCTIONS

8



12 8PCS

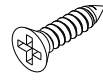

11 16PCS

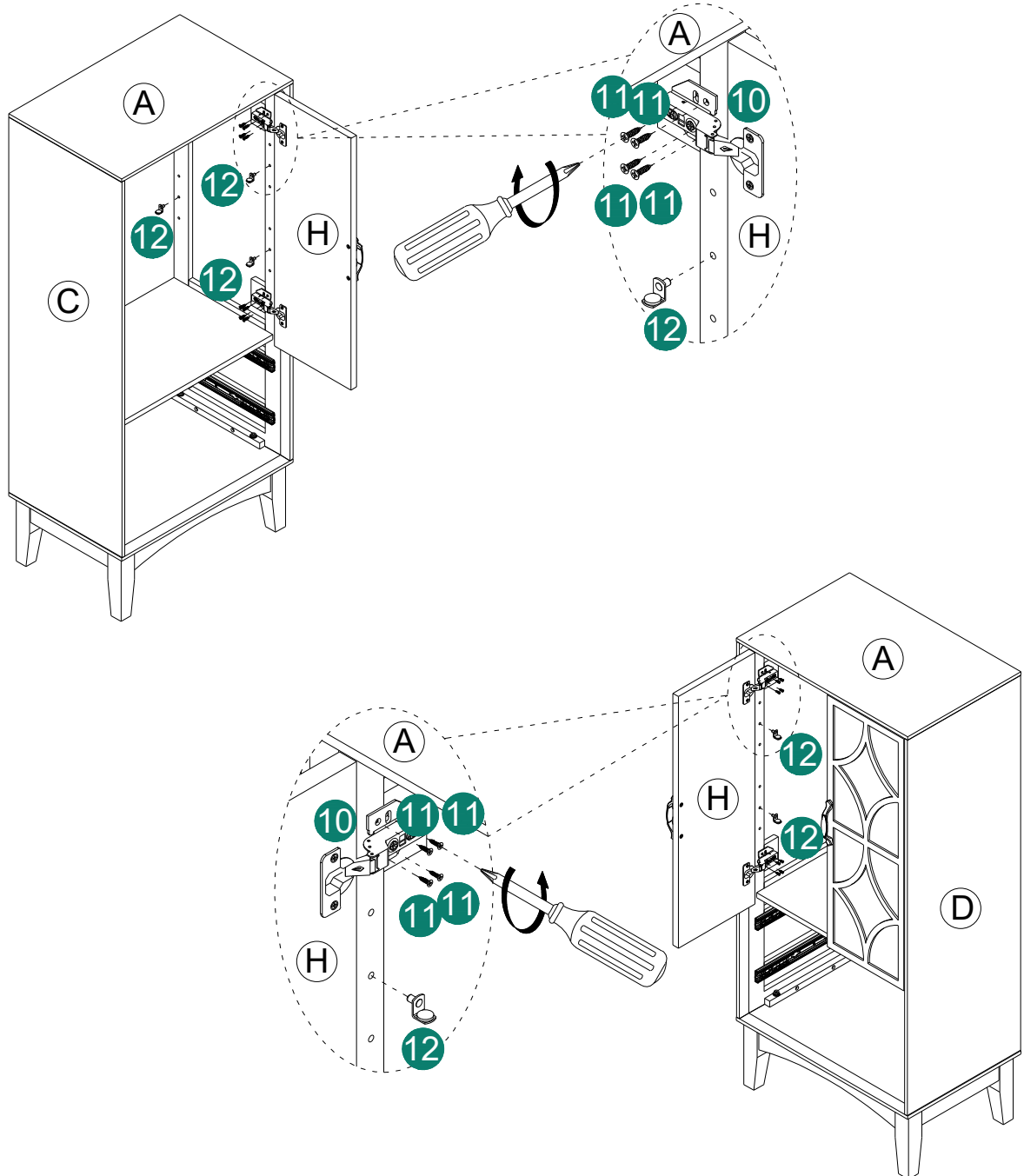

# ASSEMBLY INSTRUCTIONS

9

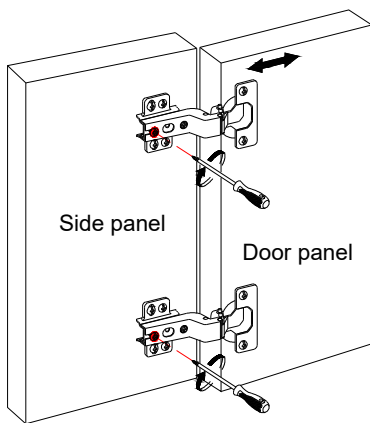

①

## Front-to-Back Direction Adjustment:

Rotate the screws on the door hinges shown in the image. The door panel can be moved front-back.

Adjustment range: 4mm

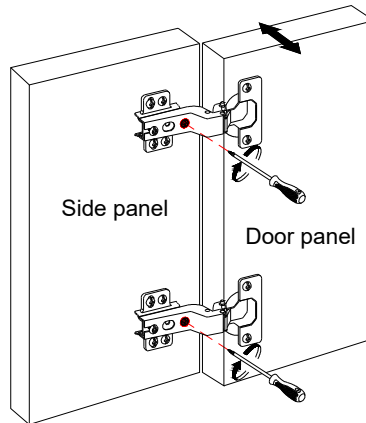

②

## Left-Right Direction Adjustment:

Rotate the screws on the door hinges shown in the image. The door panel can be moved left-right.

Adjustment range: 3mm

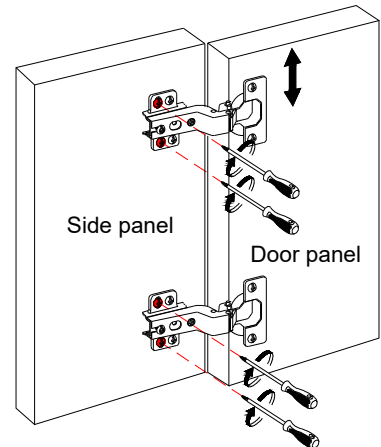

③

## Up-Down Direction Adjustment:

Rotate the screws on the door hinges shown in the image. The door panel can be moved up-down.

Adjustment range: 4mm

# ASSEMBLY INSTRUCTIONS

# 10

## Common Door Panel Issues:

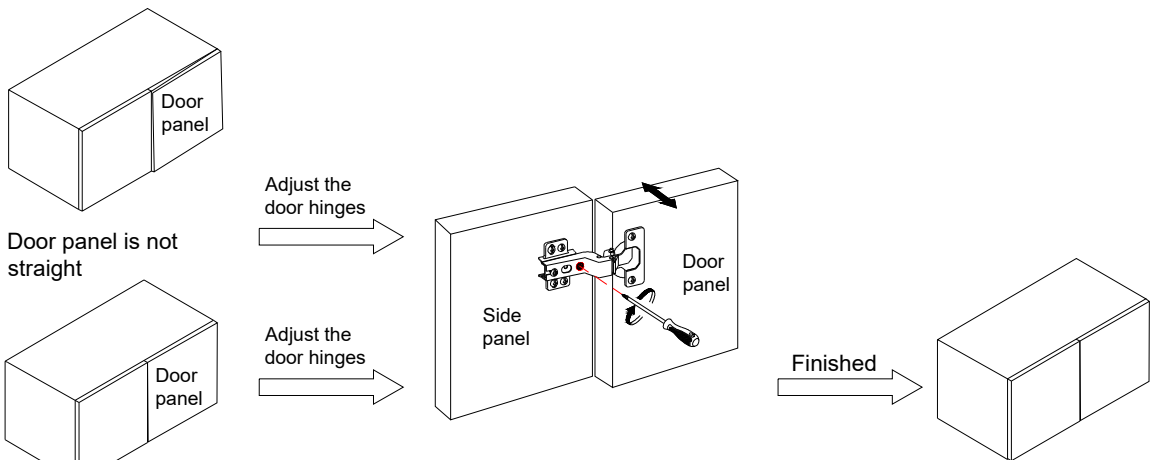

The gap between door panels is too large

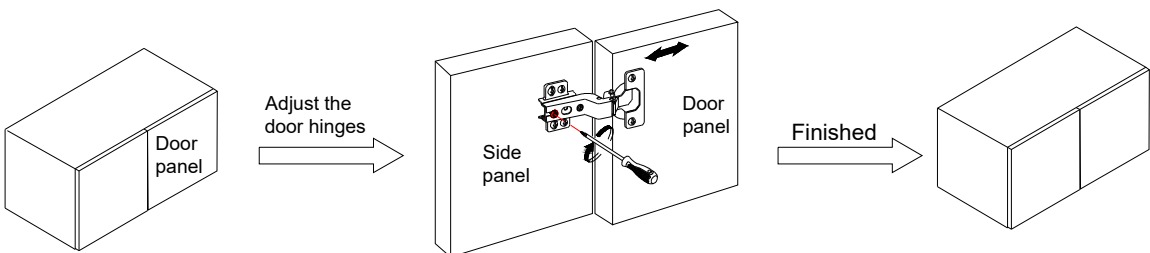

The door panels are not coplanar

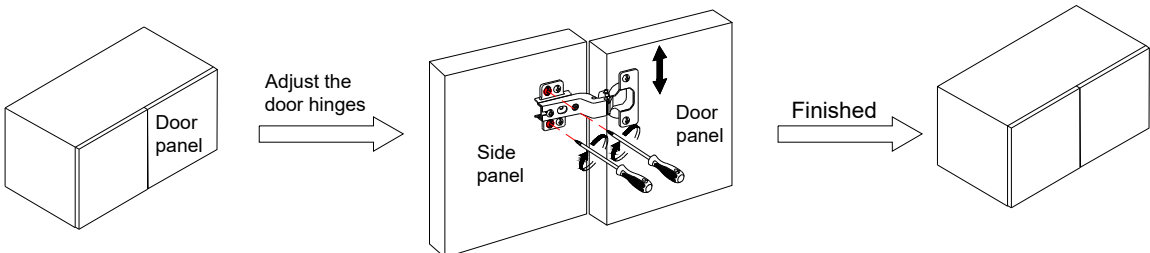

The two door panels are not at the same height

# ASSEMBLY INSTRUCTIONS

11

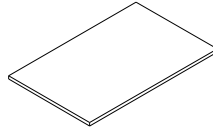

(F) 2PC

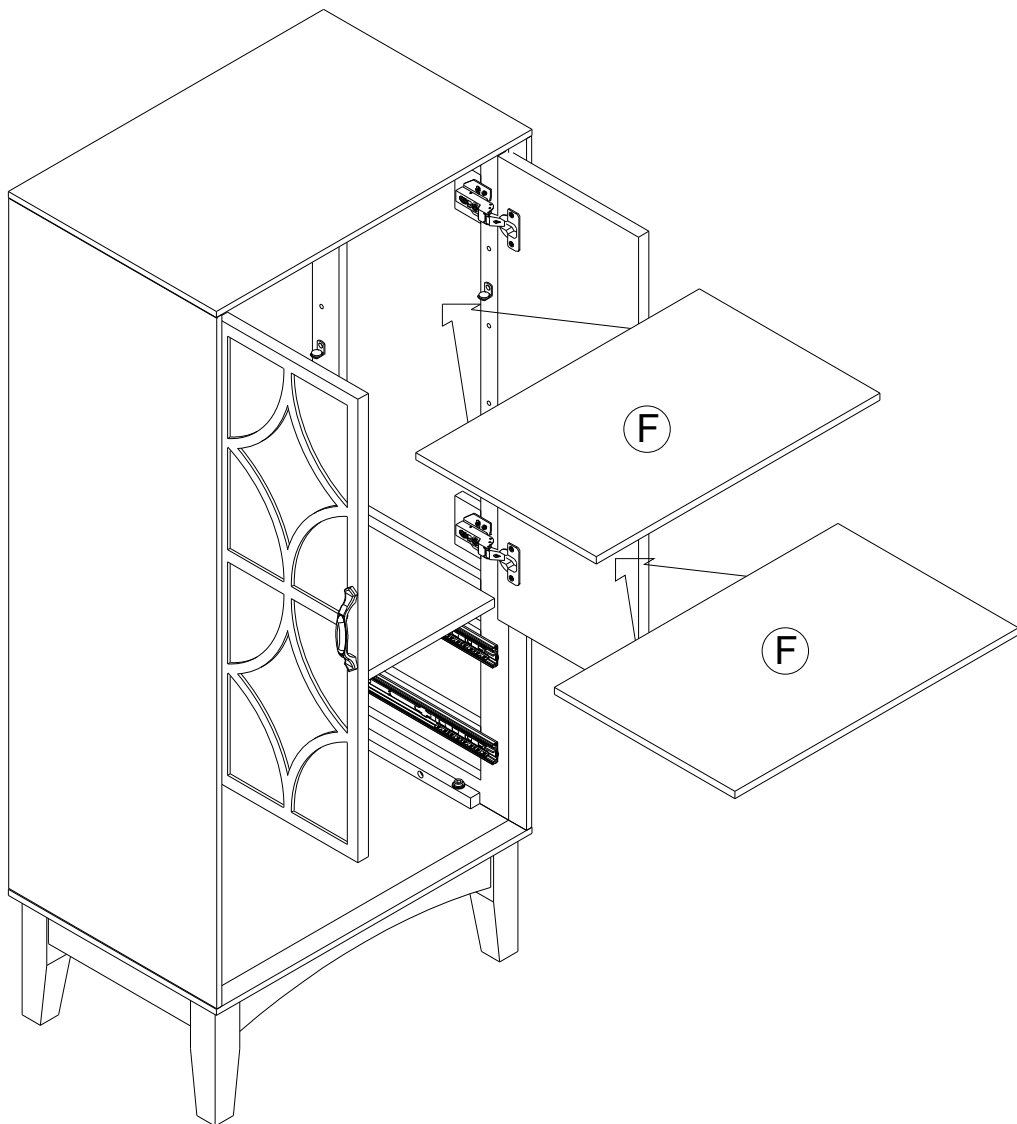

# ASSEMBLY INSTRUCTIONS

12

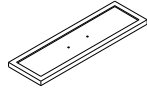

I 2PC

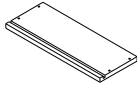

K 2PC

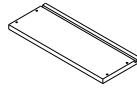

J 2PC

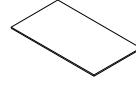

M 2PC

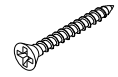

Ø3.5\*30mm

15 8PCS

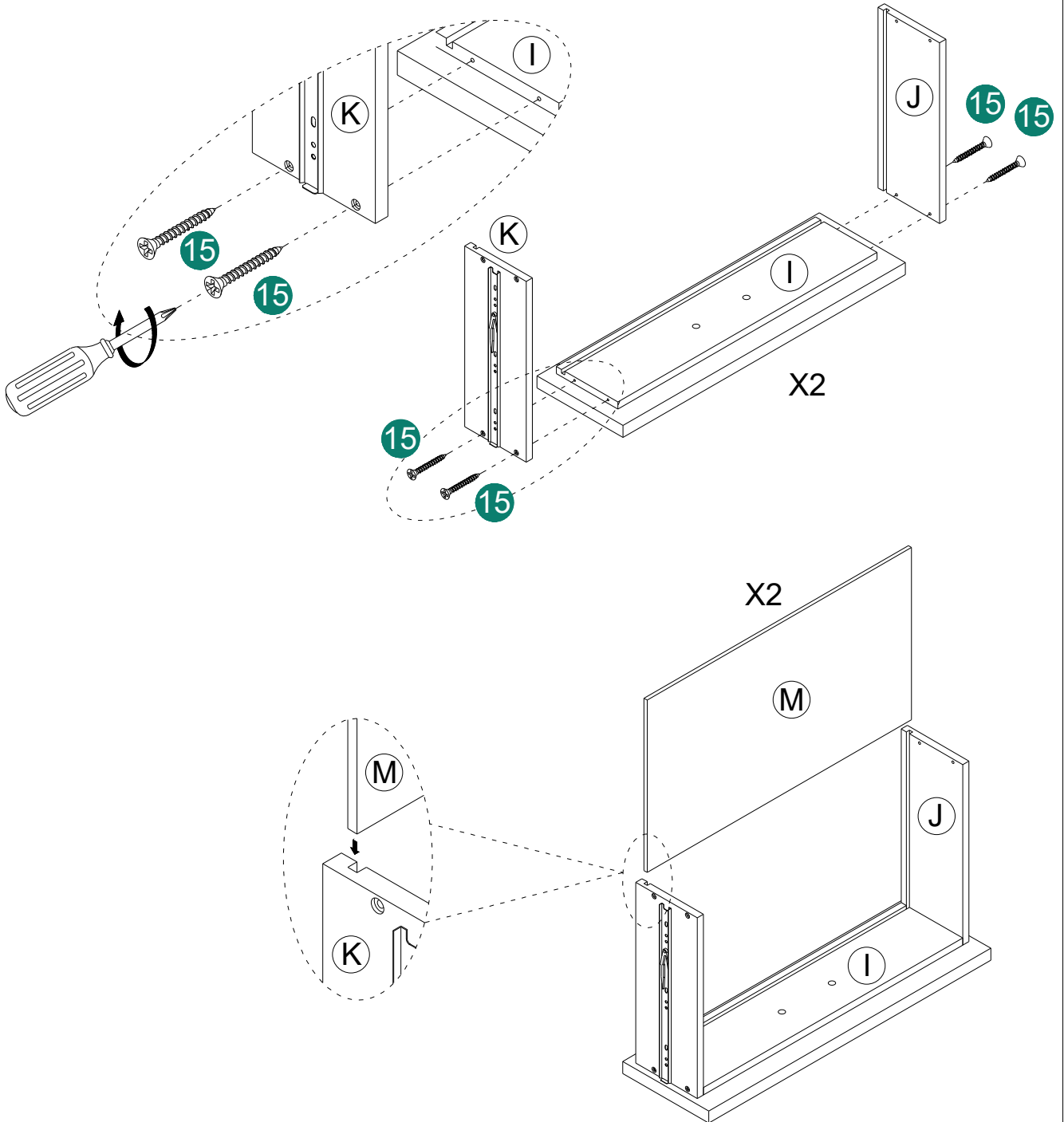

# ASSEMBLY INSTRUCTIONS

13

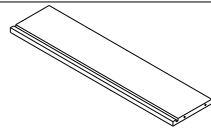

L 2PC



Ø3.5\*30mm  
15 8PCS

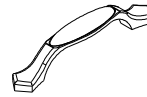

8 2PCS



Ø5/32"\*3/4"  
9 4PCS

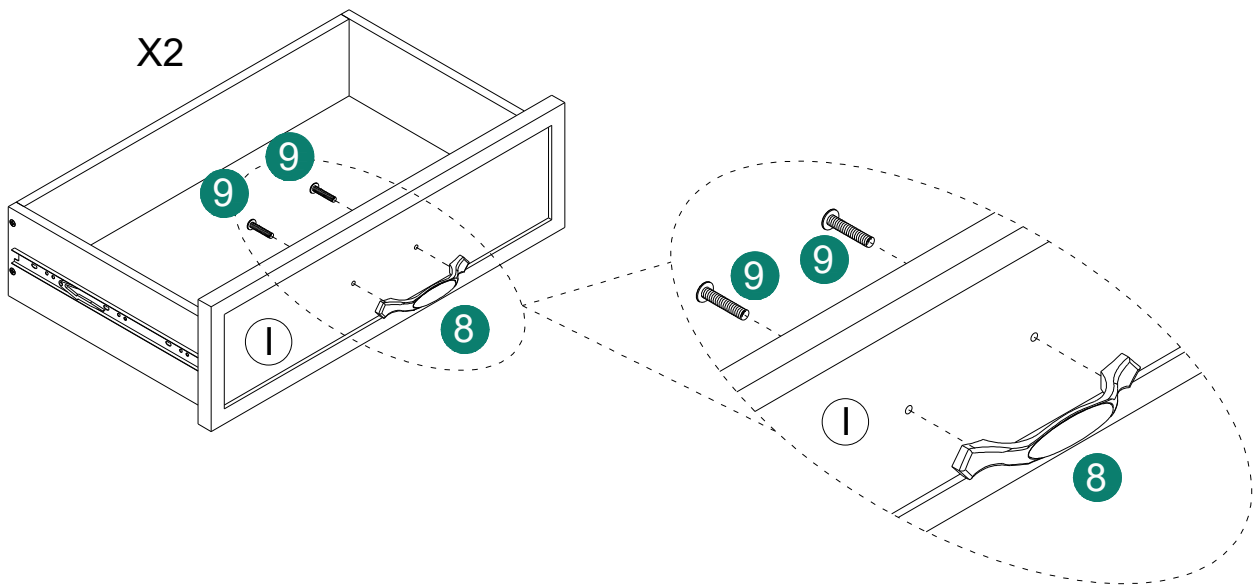
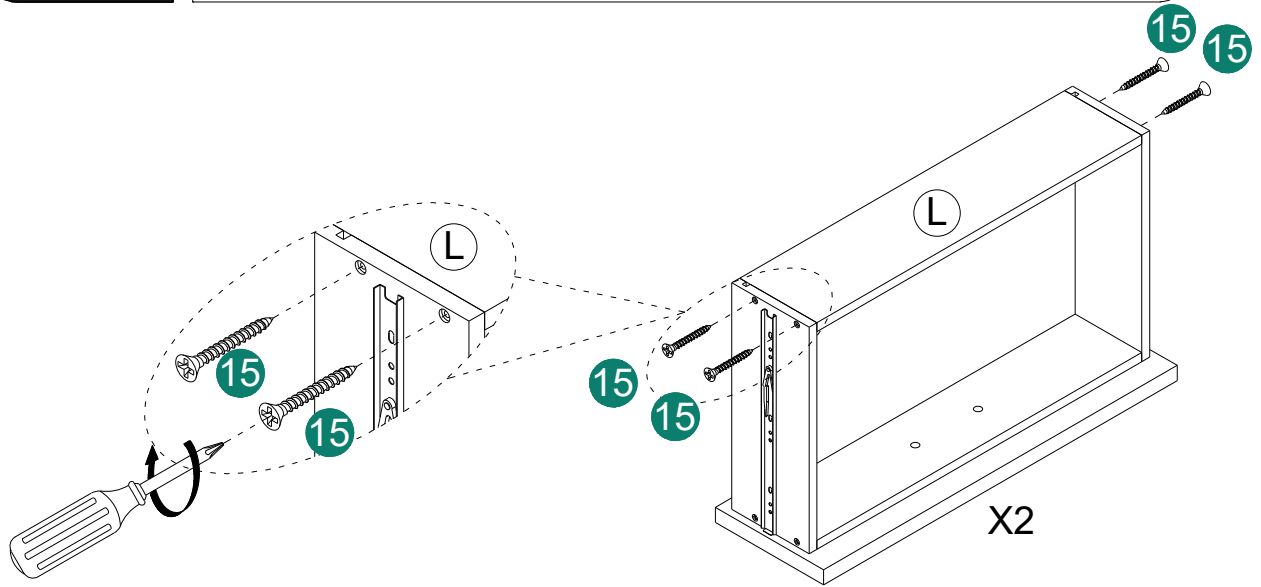

# ASSEMBLY INSTRUCTIONS

14

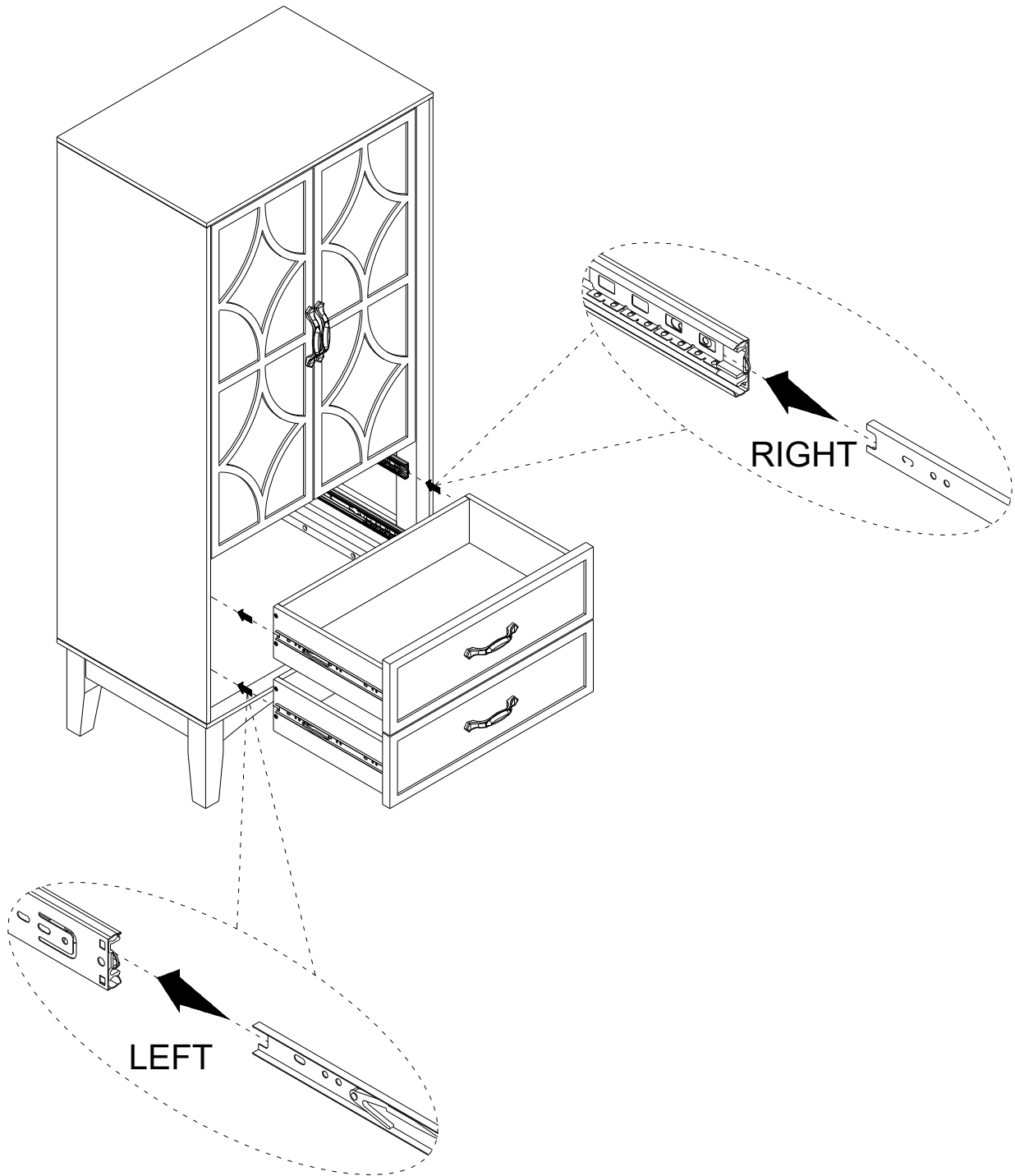

# ASSEMBLY INSTRUCTIONS

15

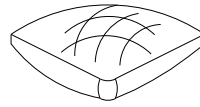

17 1set

A

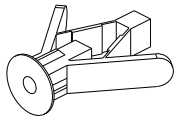

1pcs

B

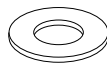

2pcs

C

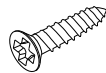

Ø8\*3/4"  
1pcs

D

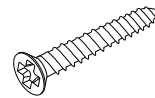

Ø8\*1-1/2"  
1pcs

E

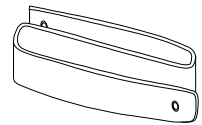

1pcs

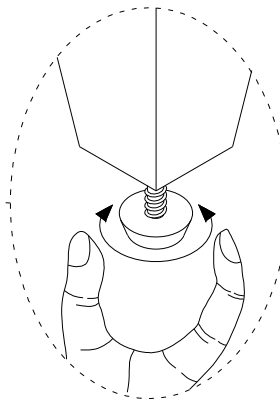
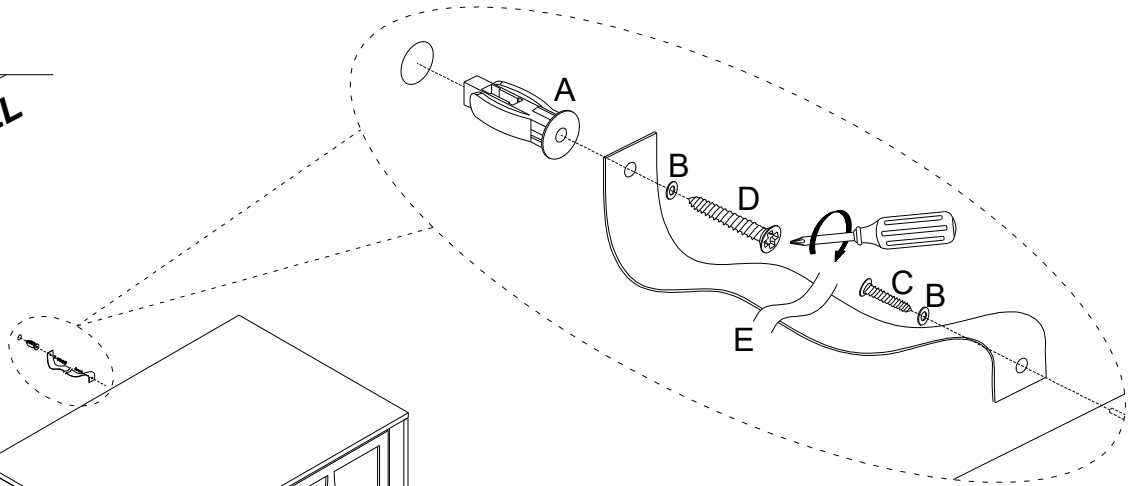
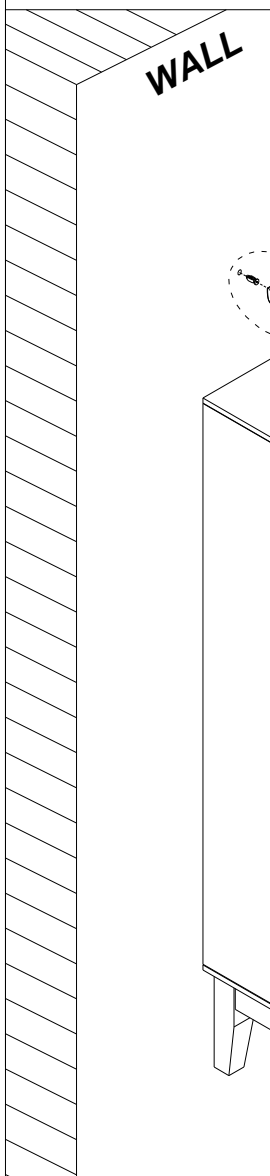

19