

Leave the Office Chair in a shady outside for 1-2 days.

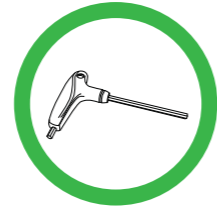

For longer use

Re-tighten bolts every 6 months by using the enclosed allen-key.
*Using an electric drill can damage the chair.
Please re-tighten bolts manually.



Safety Information



Sit in the center of the chair, with your back to the backrest



Do not sit at the front edge of the chair



Do not stand on the chair



Do not use the chair with more than one person



Do not push the chair around when a person is sitting in it



Do not push down on the backrest when a person is reclined



Do not place all your weight on only the backrest

INSTRUCTION MANUAL

Model: C-3789F

✉ HJ-Customer-Service@outlook.com

☎ (909)637-7665 | (909)637-7593

INSTRUCTION MANUAL

C-3789F

✉ HJ-Customer-Service@outlook.com

☎ (909)637-7665 | (909)637-7593

EST 9:00AM--17:00PM

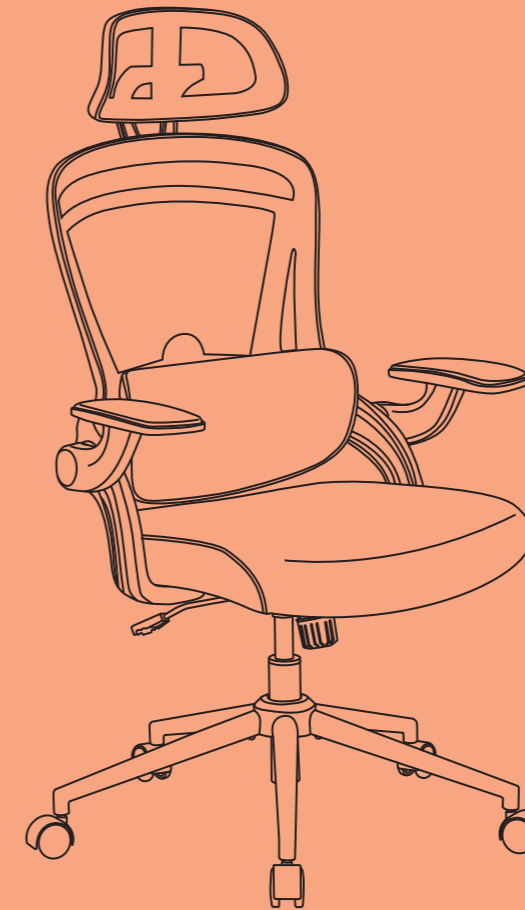

Package List



(A)*1 Backrest



(B)*1 Lumbar Support



(C)*1 Head Rest



(D)*1 Cushion

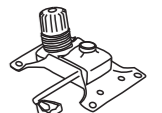

(E)*1 Mechanism



(F)*1L*1R Armrests

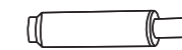

(G)*1 Gas Lift



(H)*1 Base



(I)*5 Casters



(J)*5 Legs



(K)*8 Bolts
M6x20mm

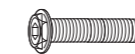

(L)*6 Bolts
M8x35mm



(M)*5 Bolts
M6x16mm



(N)*2 Bolts
M6x20mm

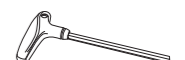

(O)*1 Wrench

Assembly Instruction

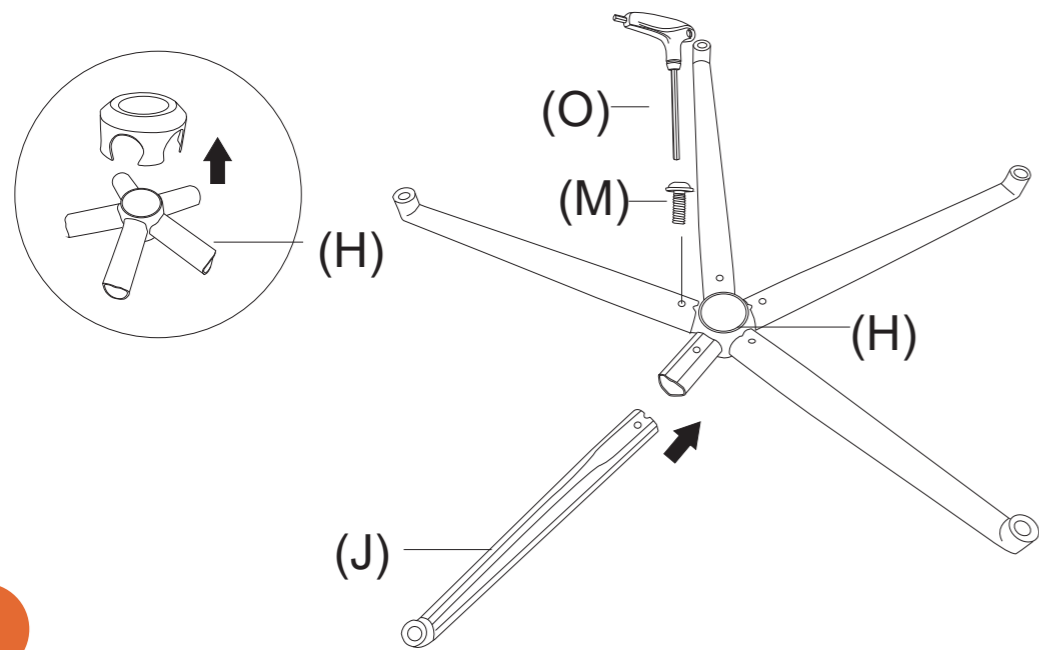
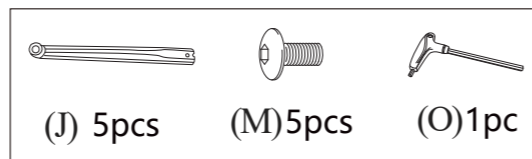

1

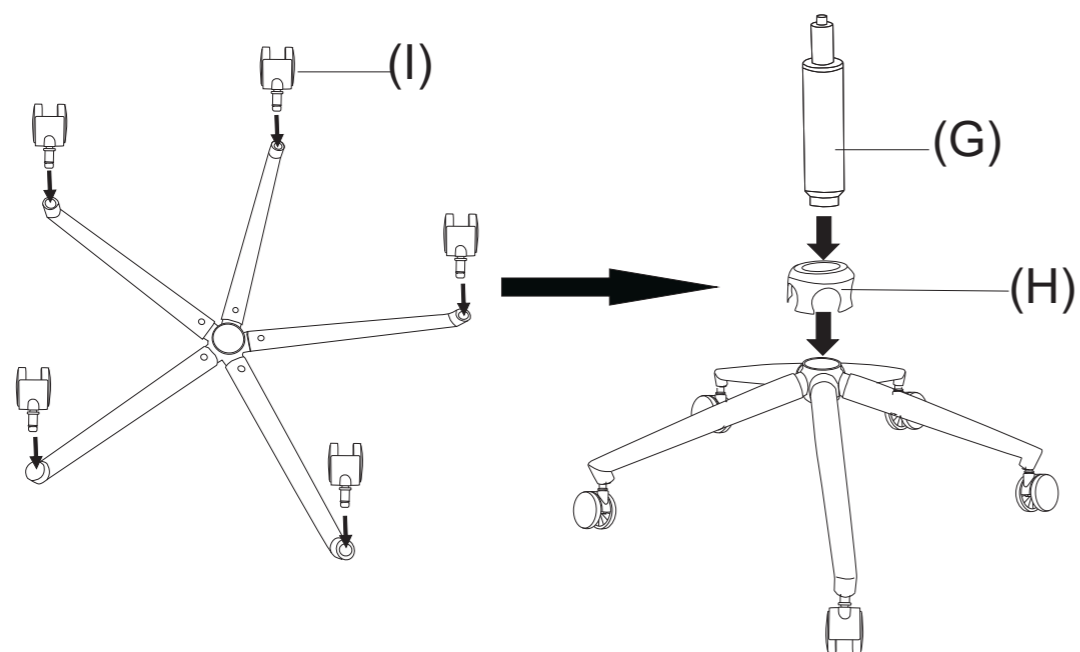
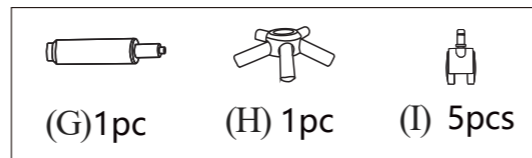

2

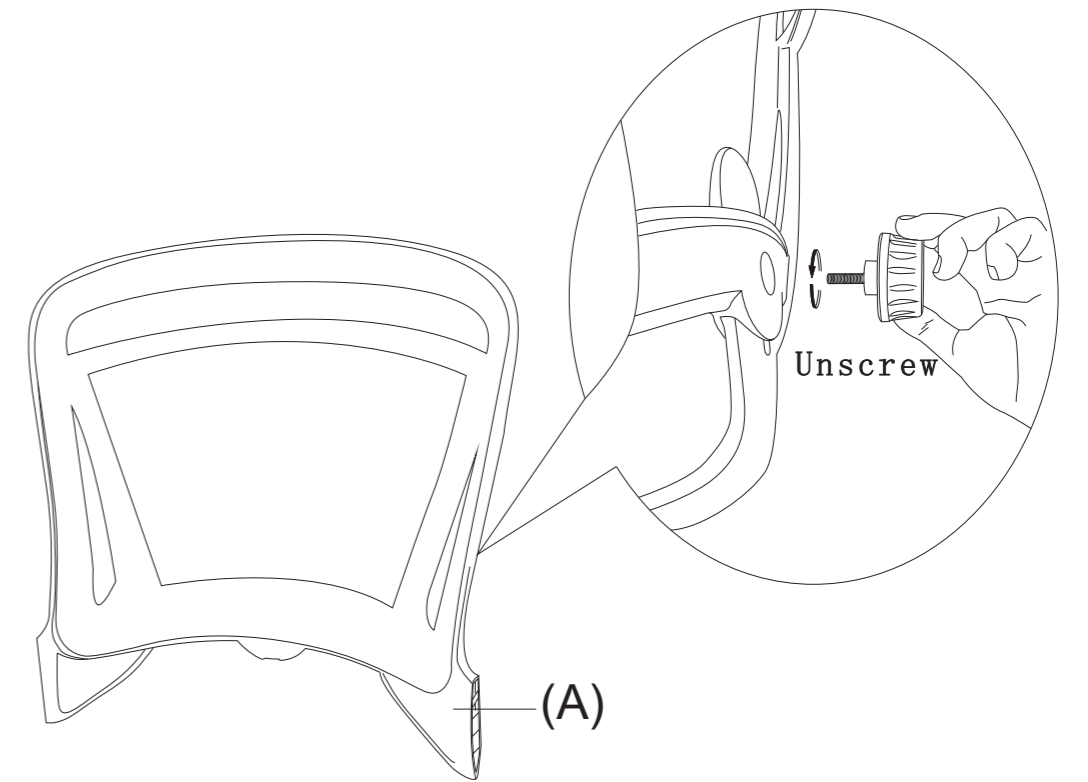

3

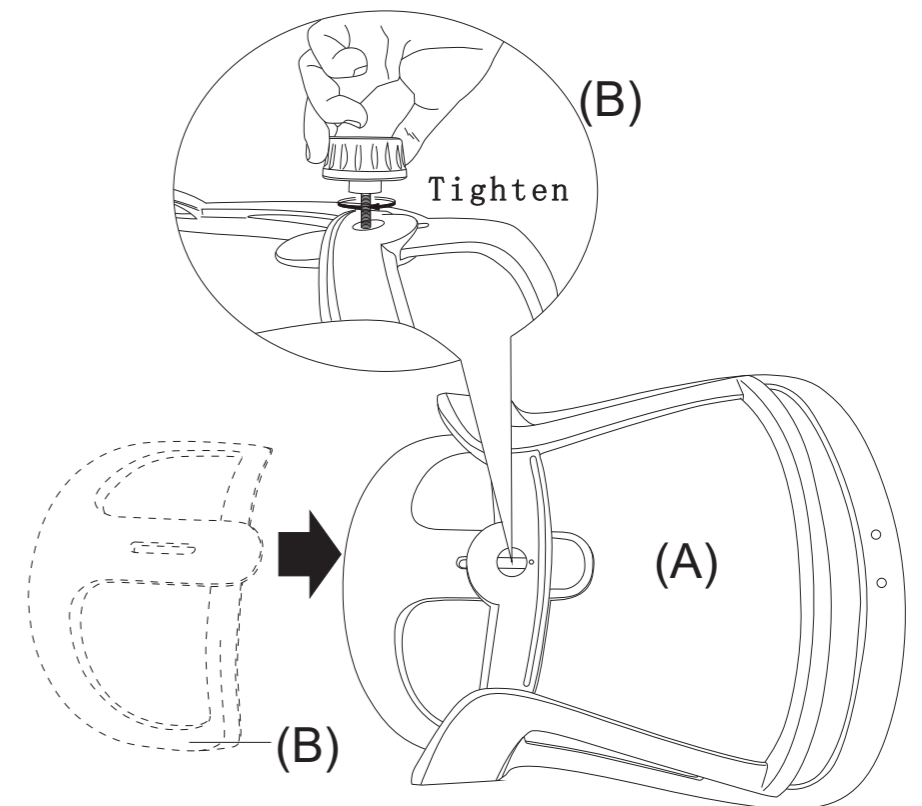

4

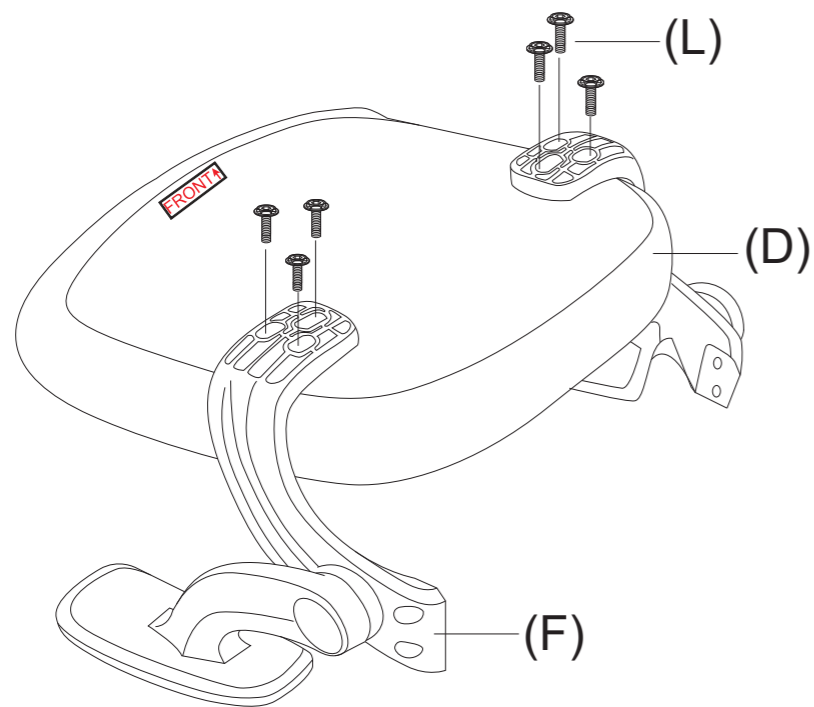
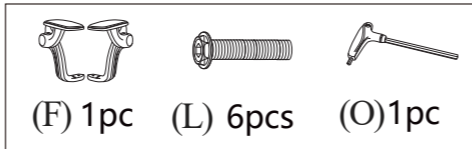

5

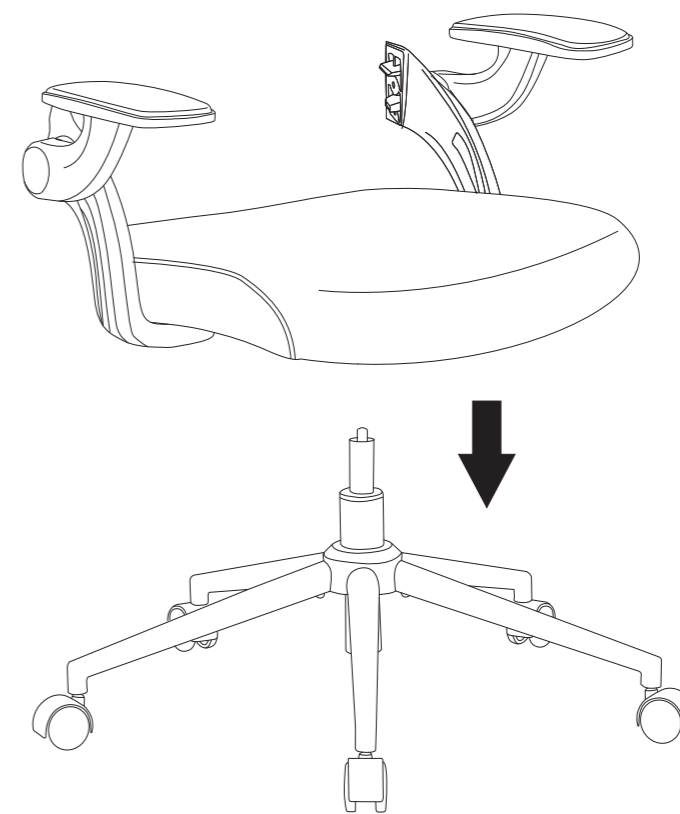

7

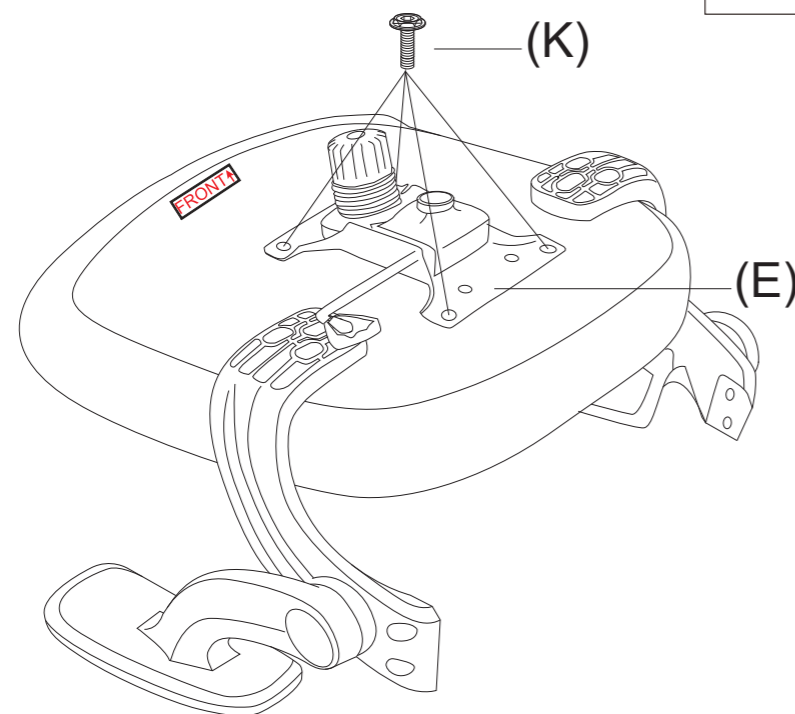
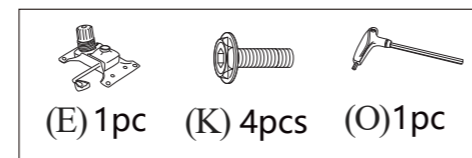

6

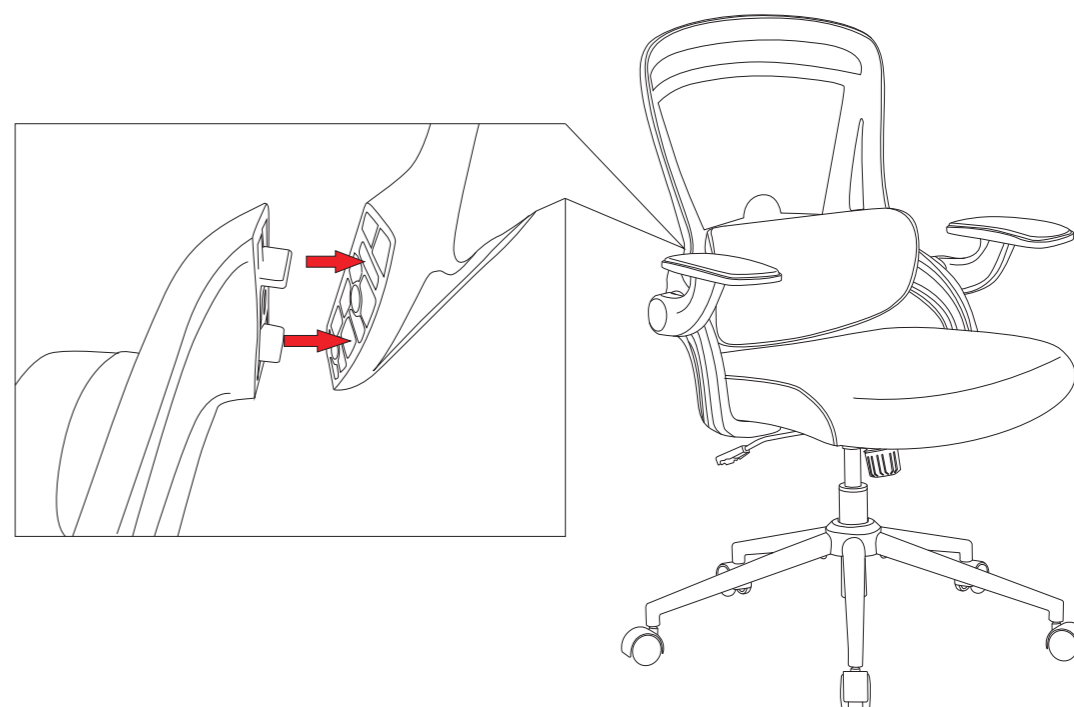

8

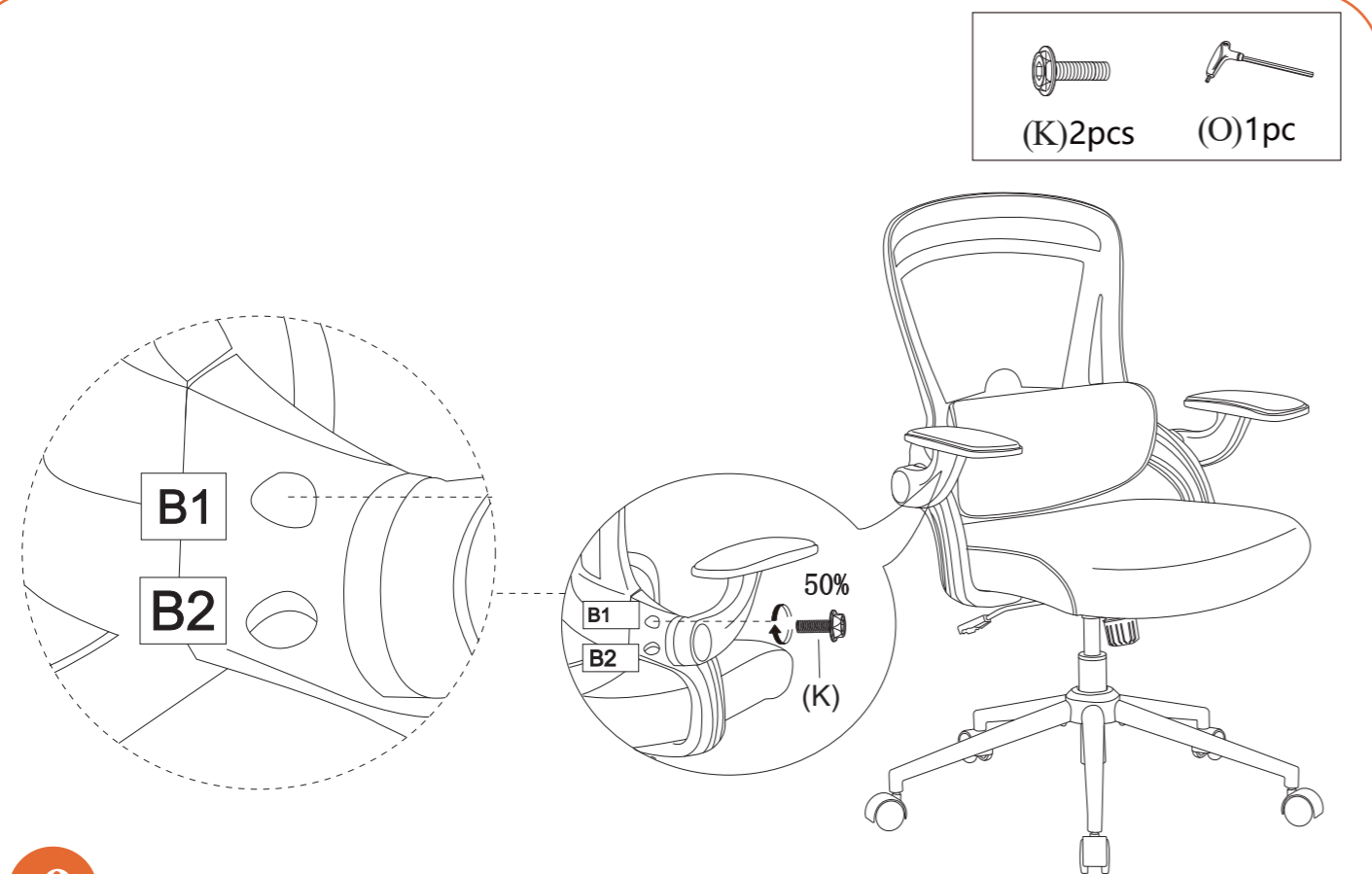

9 **NOTE:** The bolts are only tightened 50%.



11 **NOTE:** The bolts are tightened 100%.

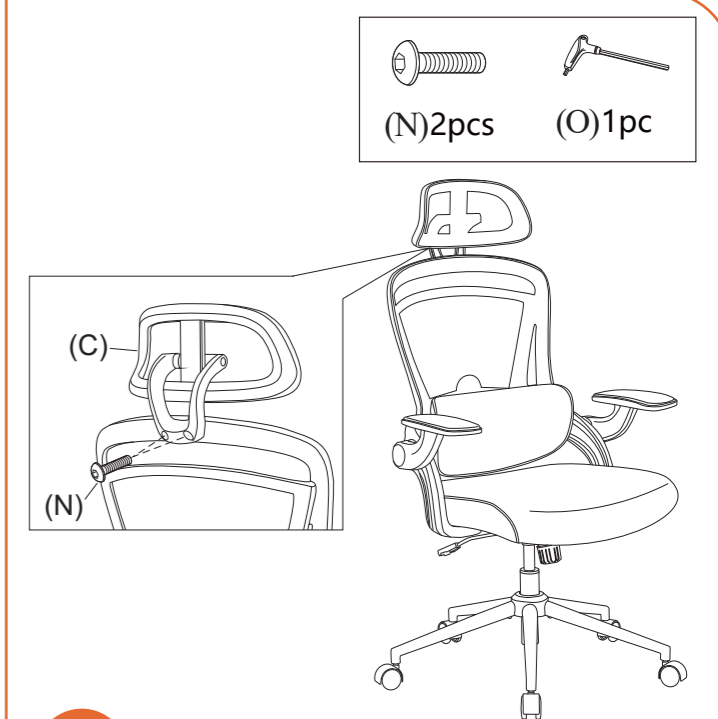

12 **NOTE:** Tighten all bolts 100% tightly.

Instructions For Use

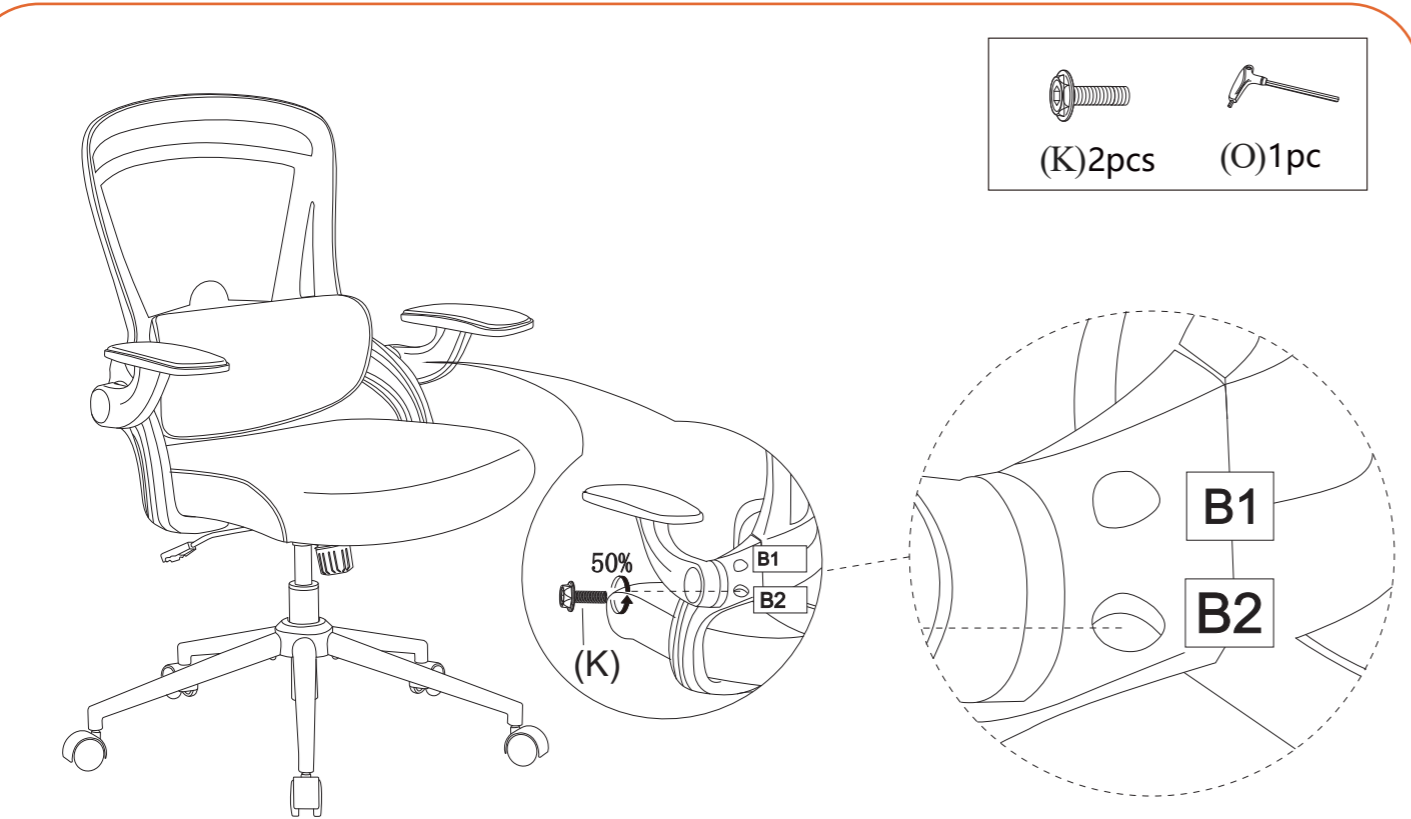
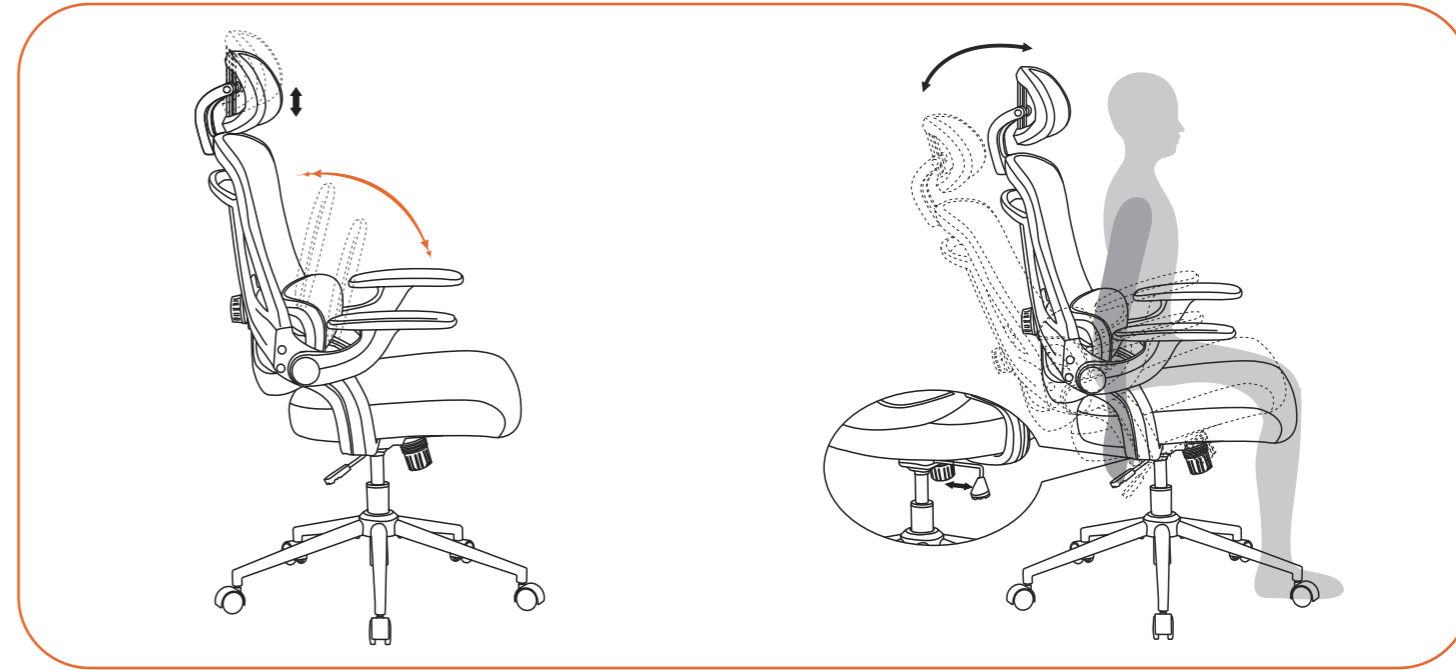

10 **NOTE:** The bolts are only tightened 50%.

CAUTION:

- * Before using the chair, check to ensure that all bolts are fully tightened.
- * Lubricate all parts and tighten all bolts every 6 months or whenever needed.

NOTE: 1. All bolts are 100% tightened.