

ASSEMBLY INSTRUCTIONS

Plastic Storage Shed_8x12 FT

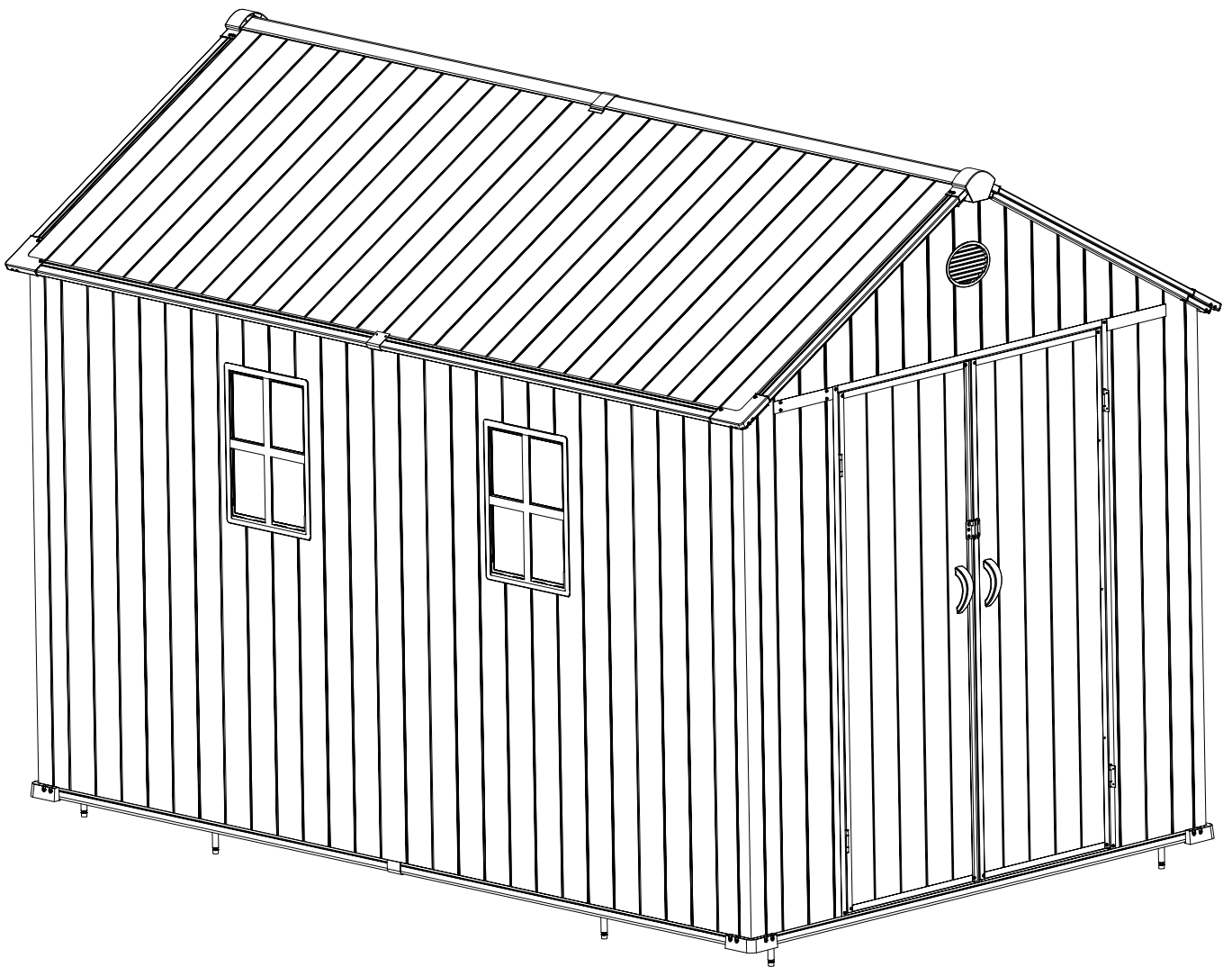

CARE AND SAFETY GUIDELINES

- The shed is intended for storage purposes only. It is not designed for habitation.
- It is strongly recommended to secure the shed to an immovable object or anchor to the ground by drilling holes in the shed floor (at the instructed locations) and inserting proper screws into the ground.
- Do not attempt assembly on windy or cold days.
- Periodically check the shed to ensure that it is stable and that the site is level.
- Be careful when handling parts with steel edges.
- When assembling or handling the shed, use only those tools listed in the user manual.
- Always wear work gloves, safety goggles and long sleeves when assembling or performing any maintenance on your shed.
- Avoid using a lawnmower or mechanical scythe near the shed.
- Wear safety goggles and always follow the manufacturer's instructions when using power tools.
- Wash the shed with a garden hose or a mild detergent solution. Do not use a metal brush or abrasive cleaners, including degreasers and oil- or acetone-based cleaning materials, as these may stain or damage the shed.
- Do not store hot items, such as recently used grills and blowtorches, and volatile chemicals in the shed.
- Avoid placing heavy items against the walls, as this may cause distortion.
- Keep the roof clear of accumulated snow and leaves. Large amounts of snow on the roof can damage the shed, making it unsafe to enter.
- Wind direction is an important factor to consider when determining the location of the shed. Reduce exposure to the wind, in general, and of the door side in particular. Keep doors closed and locked when the shed is not in use to prevent wind damage.
- Do not stand on the roof.
- Consult your local authorities to check if permits are required to erect the shed.

Installation Precautions

1. Site preparation

Leveling the ground.



2. Set up the base

It is recommended to build a wooden base or concrete base.

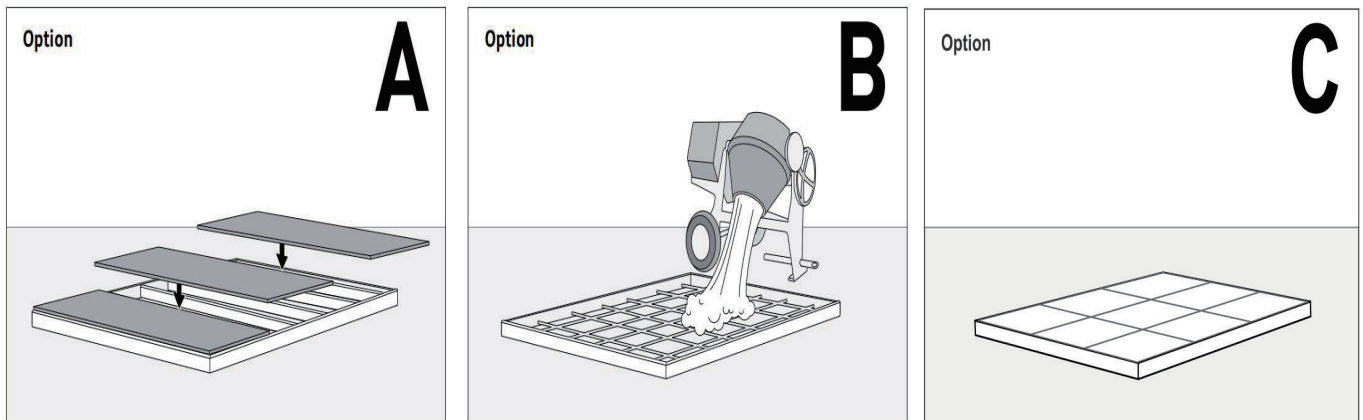

3. Leave enough space

Operating space shall be reserved for external installation work.

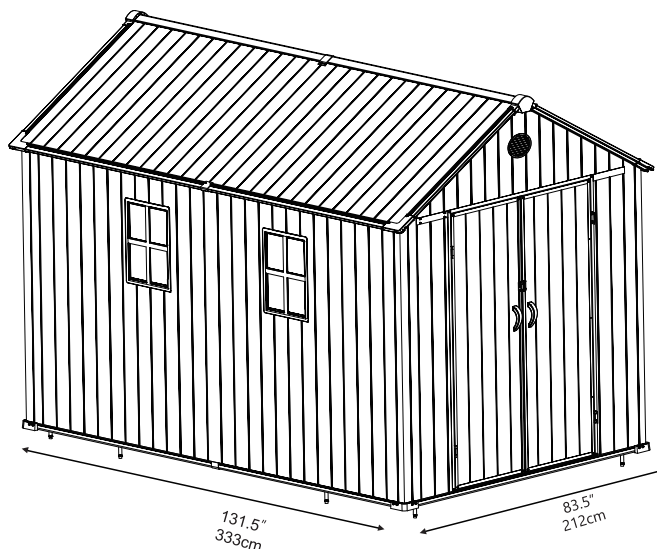

Contents

REQUIRED TOOLS

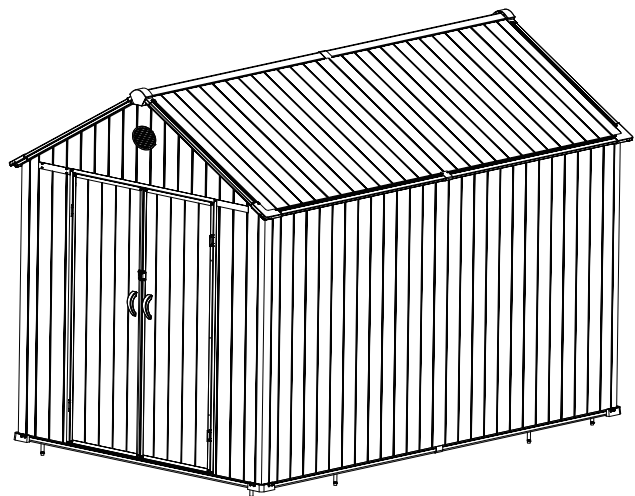
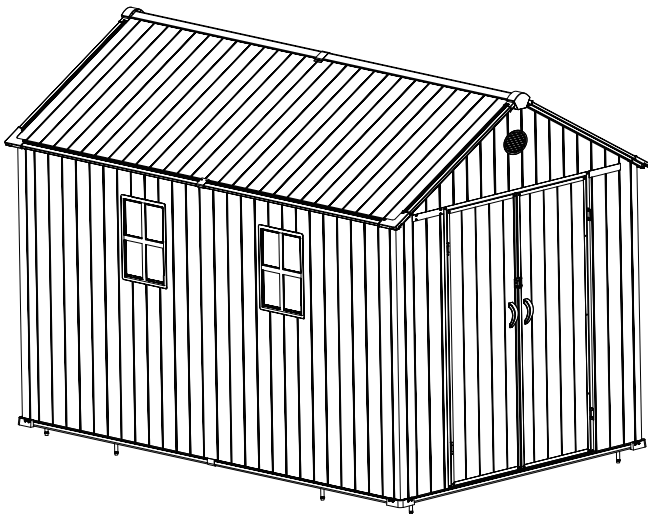
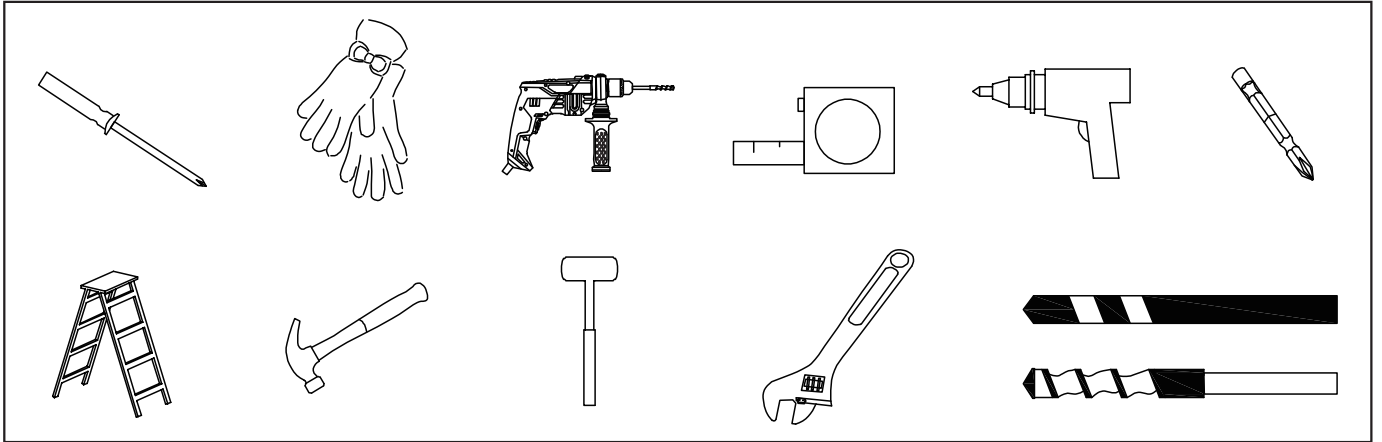









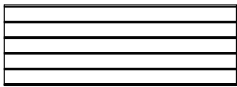
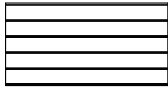
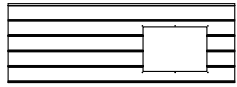
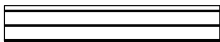
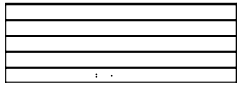
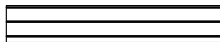
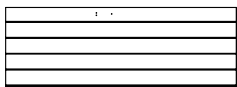

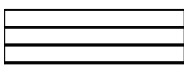

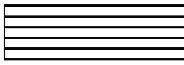
Accessories & Parts 1

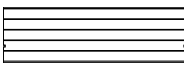

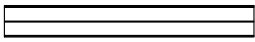

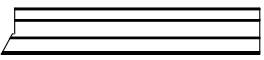

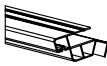



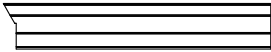

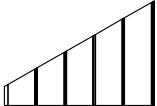

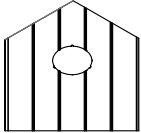

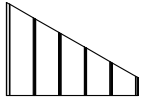
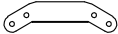
"IMPORTANT, RETAIN FOR FUTURE REFERENCE: READ CAREFULLY"

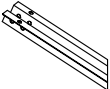

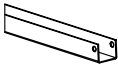
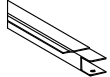

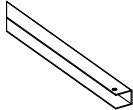



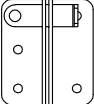



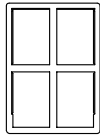

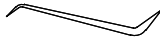
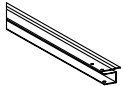

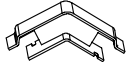

1. Gather and organize all required parts before assembling.
2. Assemble shed on a flat, clean surface.
3. Two or more people are required for assembly.

Item No.	Reference Image	Qty.	Item No.	Reference Image	Qty.
AQT		X11	ASD		X10
AQA		X2	ACG		X1
AQB-1		X1	ACE		X1
AQB-2		X1	ADZ		X4
ASE		X2	DCT		X4
DCC		X4	ZY-ZJ		X2
DCC-A		X1	CC		X2
DCB		X1	DZ-ZJ		X2
ALA		X2	BAC		X4
			BAD-B		X4

Accessories & Parts 2

Item no.	Reference Image	Qty.	Item no.	Reference Image	Qty.
ALB		X2	BHD		X2
			BHD-B		X4
ASA		X2	BAE-B		X2
ASB		X2	BHA		X2
ASC		X2	JAC		X2
BHC		X1	JAA		X4
LQT		X1	JAB		X2
RQT		X1	TQC		X2
C1		X1	A		X2
C2		X4	B		X8
C3		X2	C		X1

Accessories & Parts 3

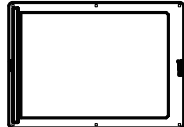
Item no.	Reference Image	Qty.	Item no.	Reference Image	Qty.
C5-1		X1	E		X2
C5-2		X1	N		X2
C6		X1	M	 M4X14mm	X16
F		X4	O	 M5X20mm	X16
G		X1	P	 M4X14mm	X4
H		X2	Q	 M5	X12
I		X6	R	 M5X30mm	X12
J	 M4X30mm	X2	S	 M6X80mm	X8
K	 M4X40mm	X4	T		X8
L	 M5X14mm	460	HG-1		X2

Window Installation

1

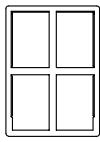

ⓔ 2pcs

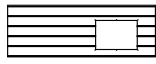

ⓐⓐ 2pcs

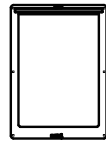

ⓓⓖ-1 2pcs



Ⓛ 12pcs

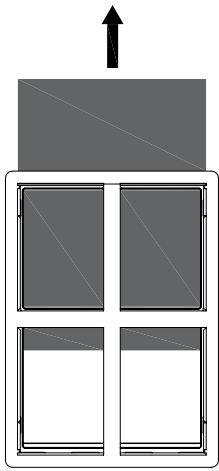
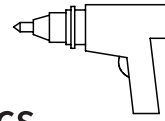

ⓔ

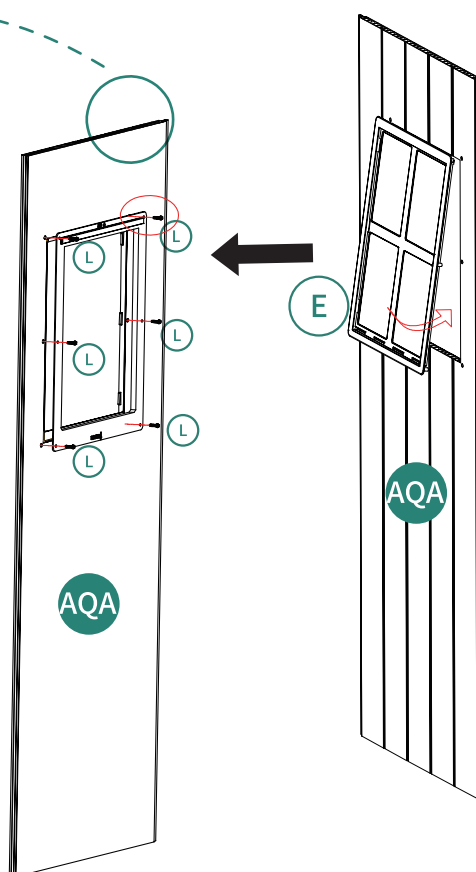
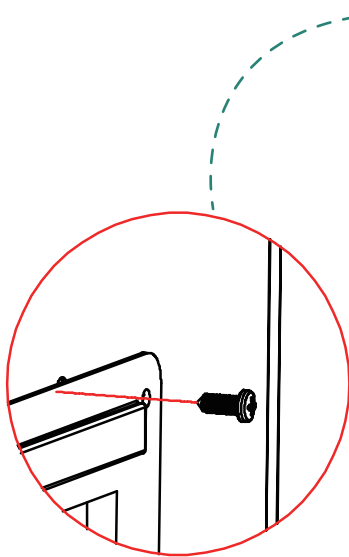
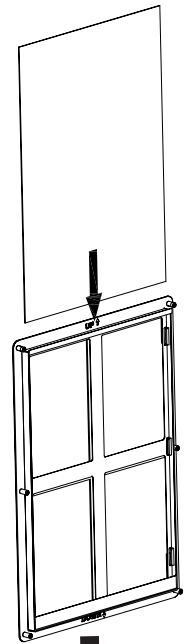

ⓔ

ⓐⓐ



ⓔ



ⓐⓐ

Roof Support Installation

2

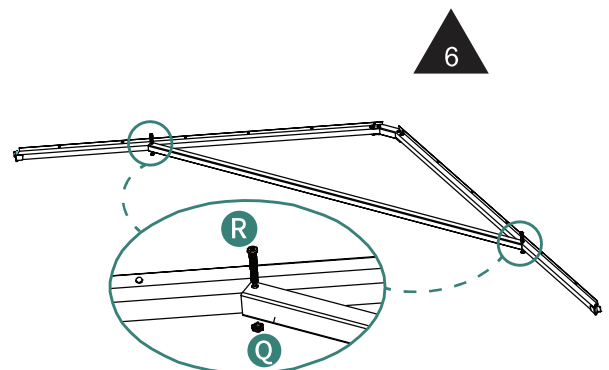
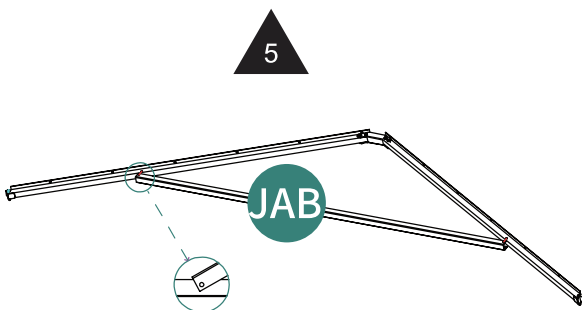
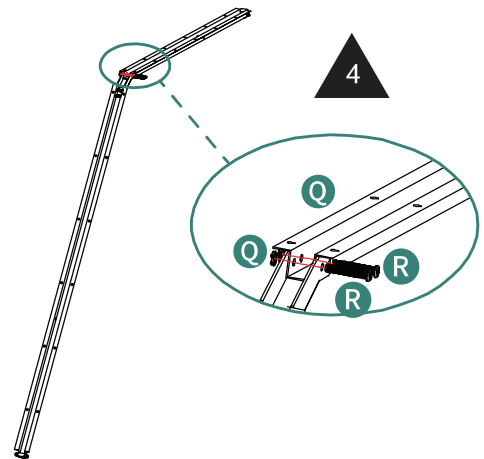
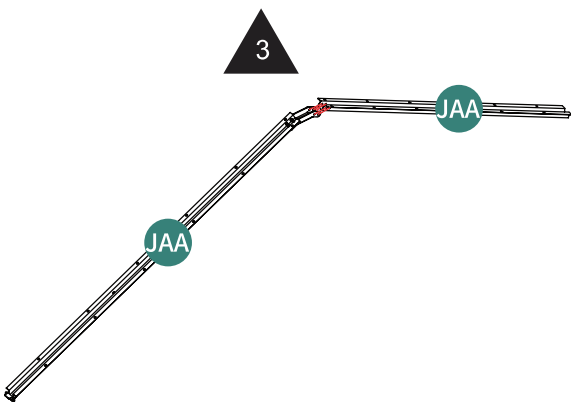
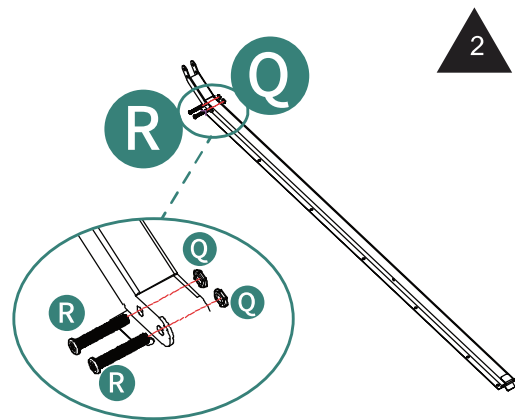
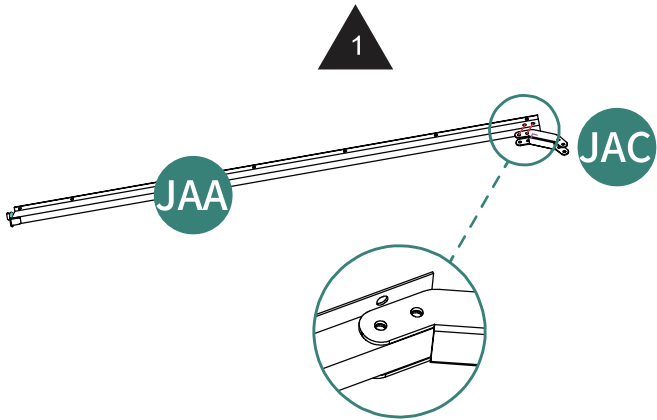

Base Installation 1

3

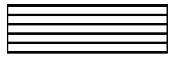

DCC 4pcs

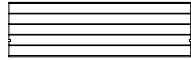

DCC-A 1pc

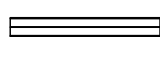

DCB 1pc



L 15pcs

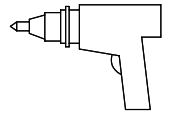
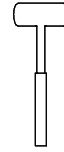

Note: Put the strips face upwards!
Fully fit the panels to each other to avoid any gap.

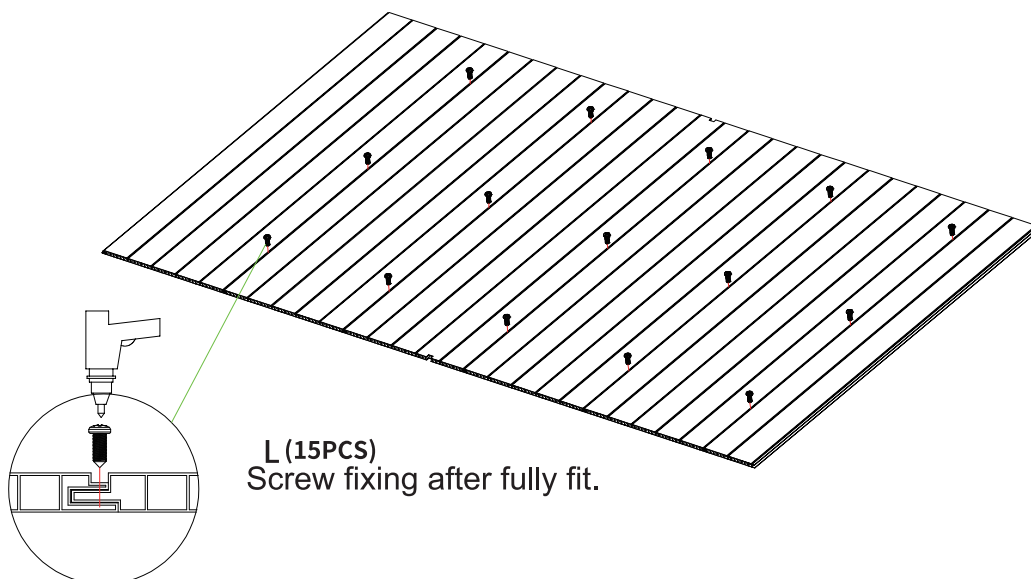
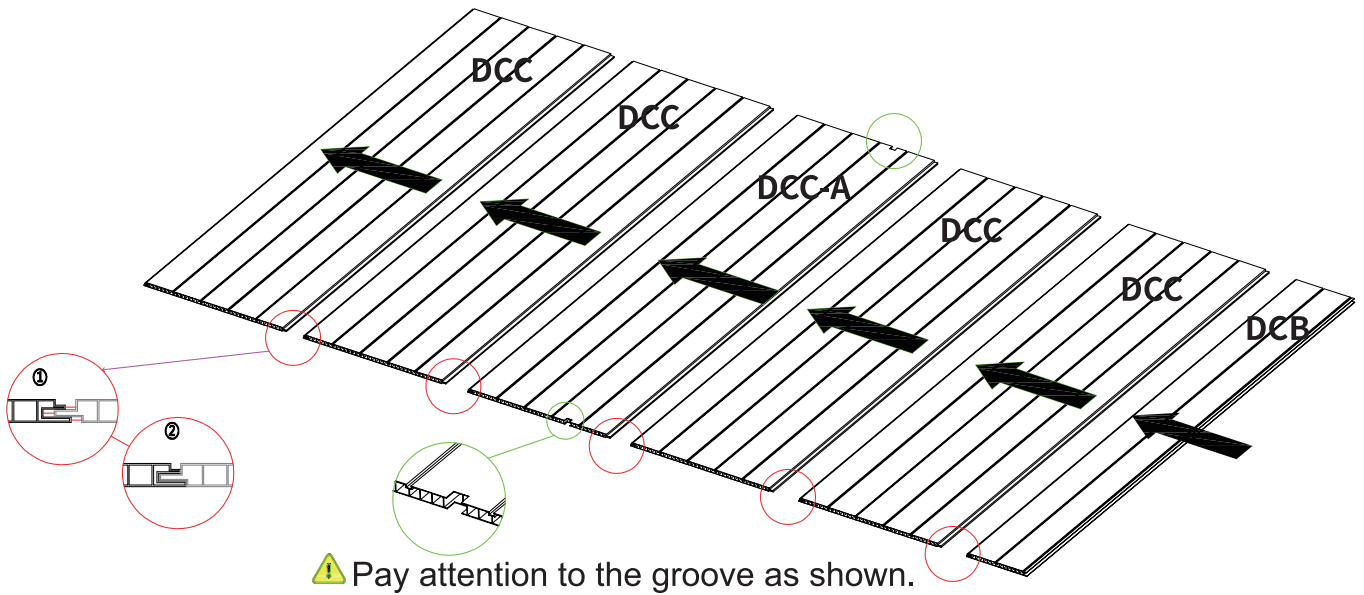

Base Installation 2

4



ADZ 4pcs

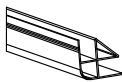

BHD 2pcs

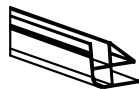

BHD-B 4pcs



DZ-ZJ 2pcs



L 28pcs

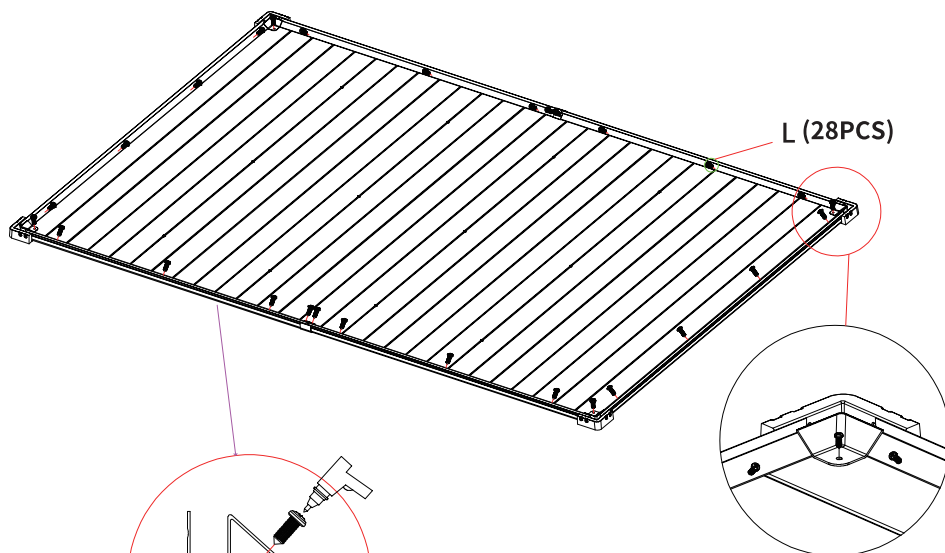
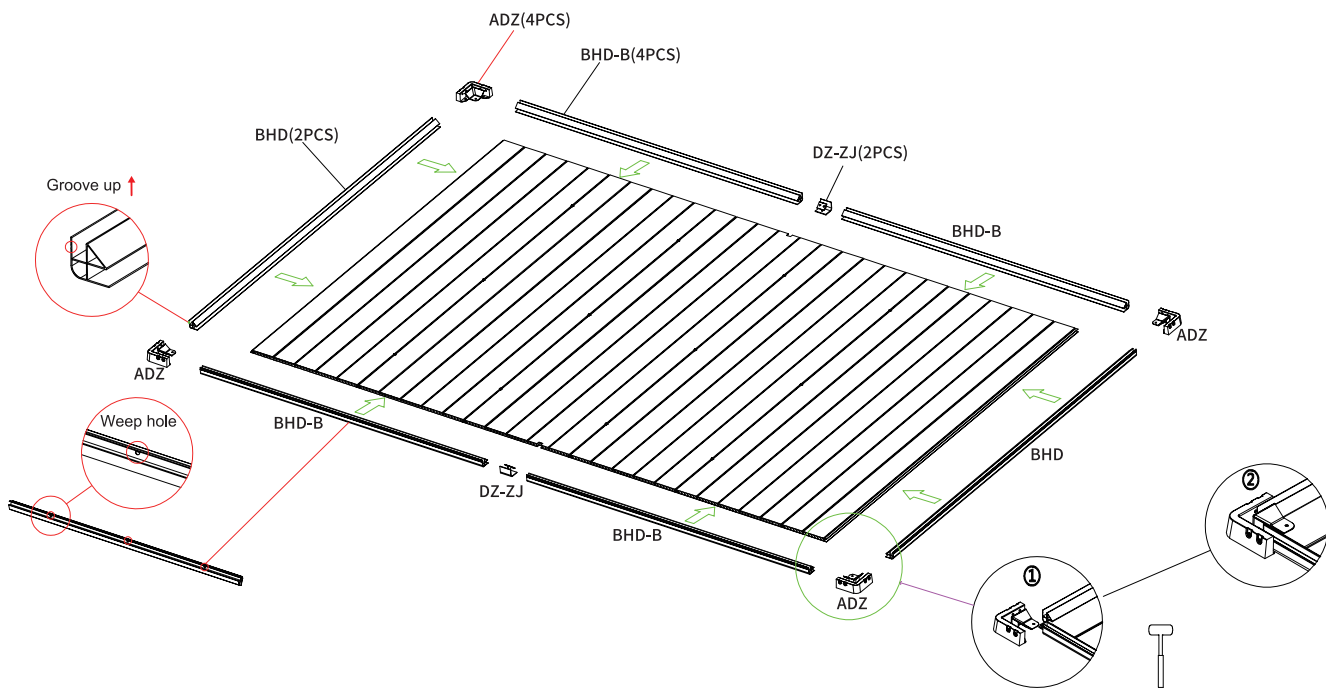
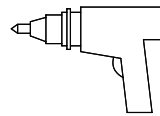

Screws fixing BHD,BHD-B,ADZ,towards floor panel.

5

ALA 1pc AQT 5pcs

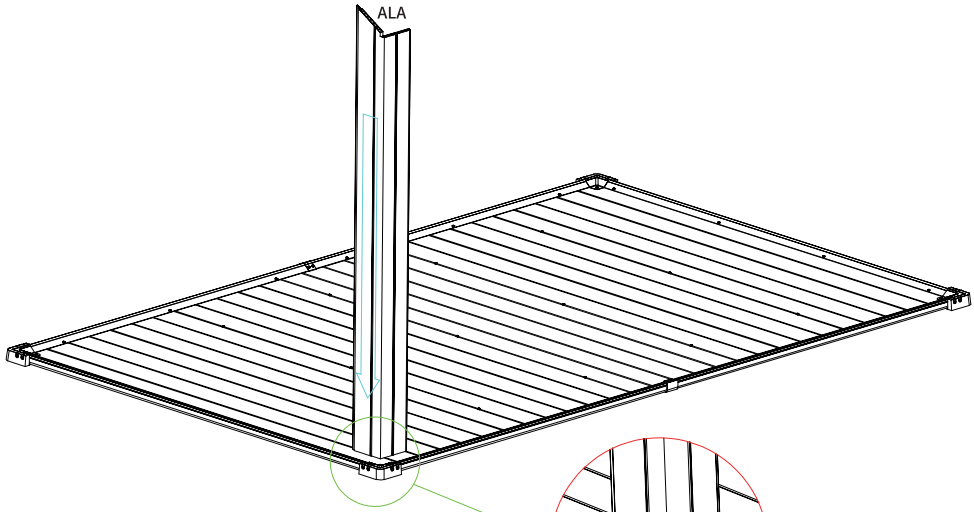

Fully fit the panel inside the profile.

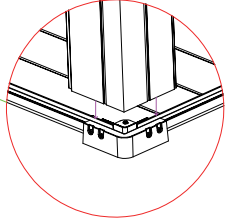

Fully fit to each other without any gap.

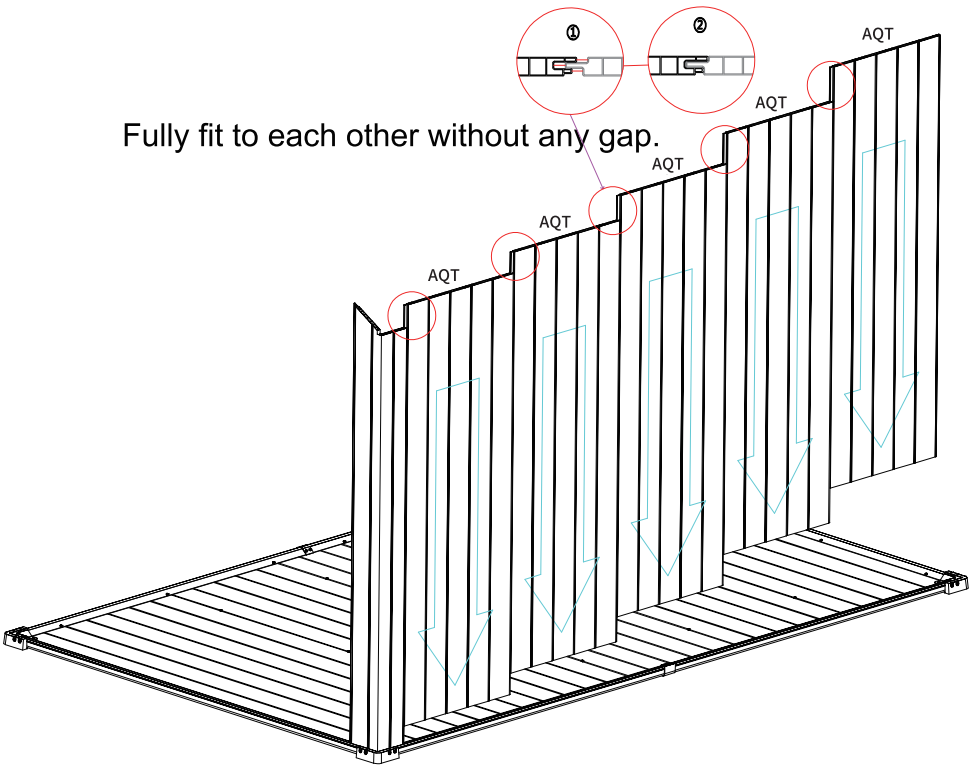

6

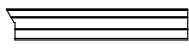

ALB 1pc

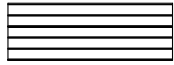

AQT 3pcs

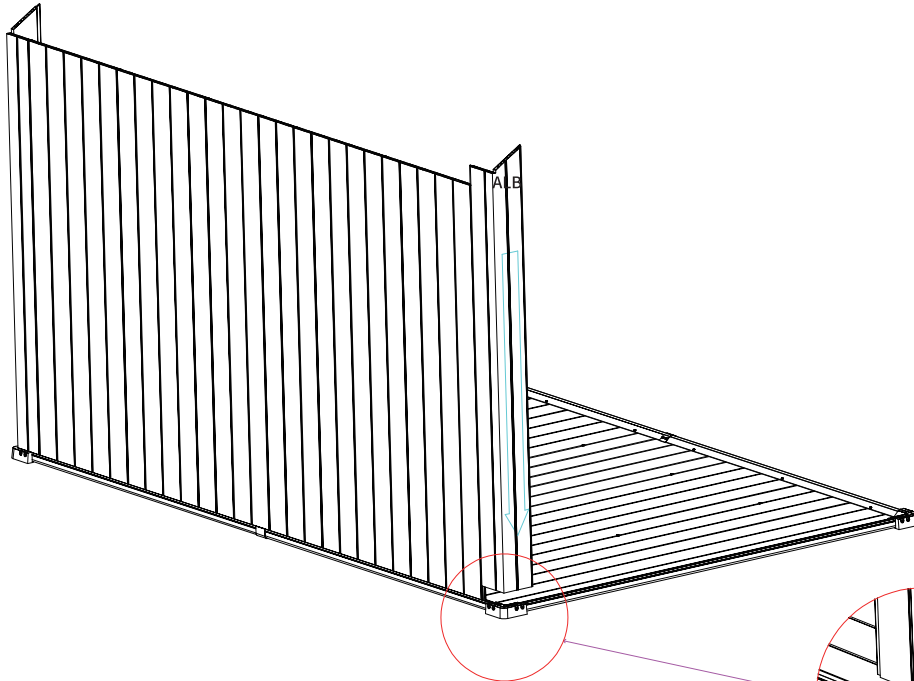

Fully fit the panel inside the profile

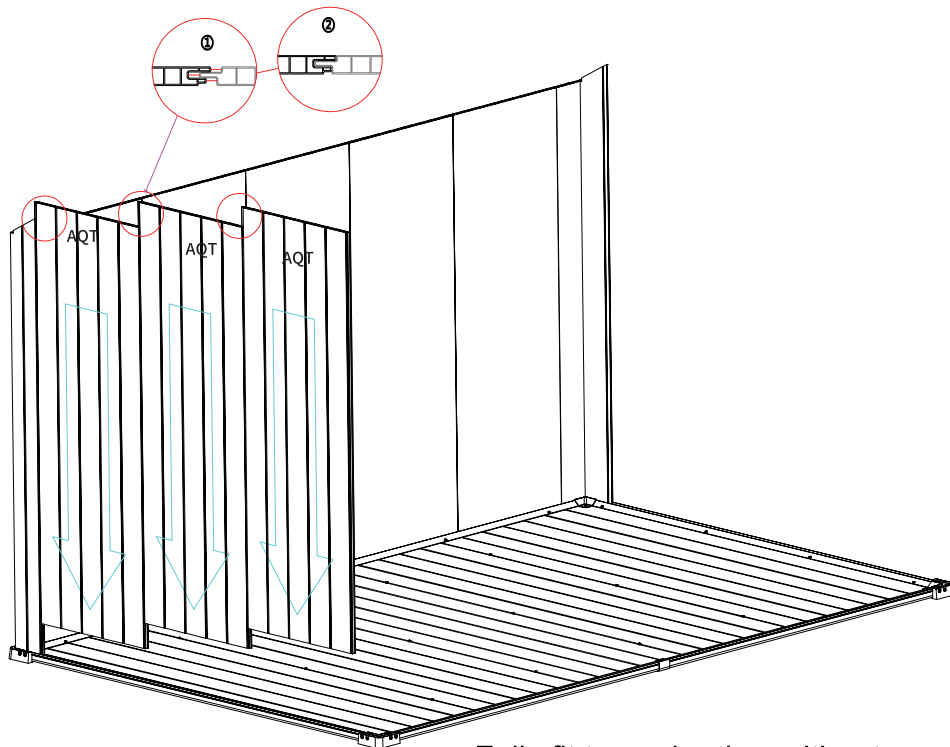
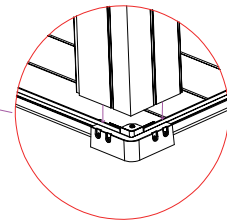

Fully fit to each other without any gap.

7

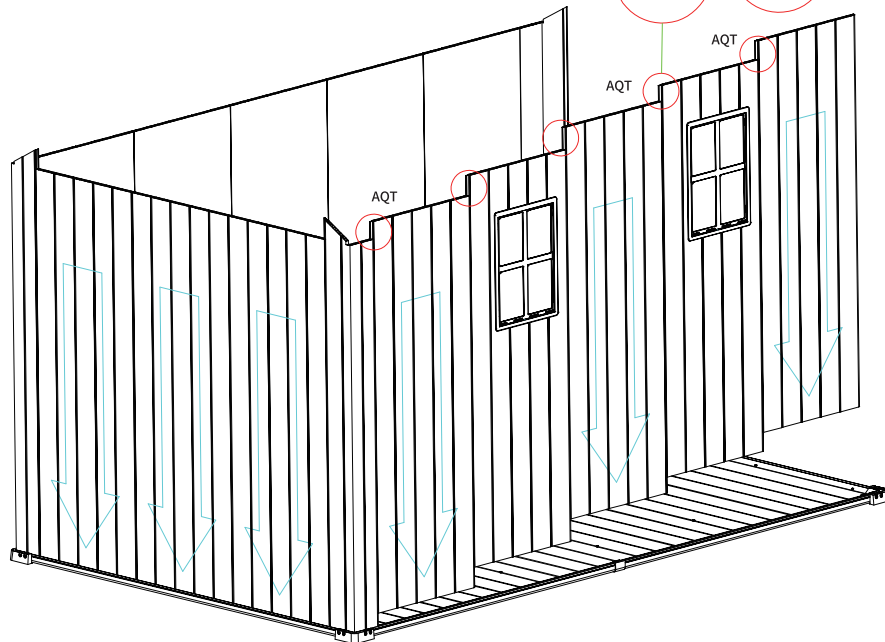
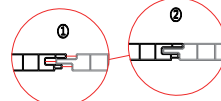
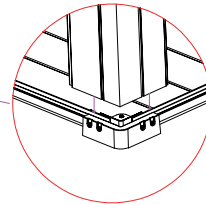
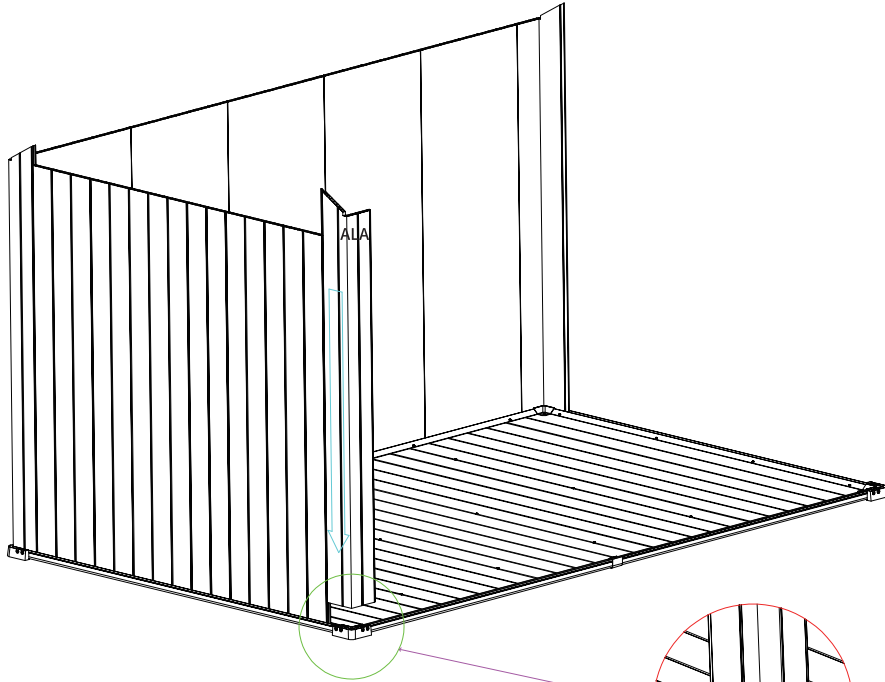
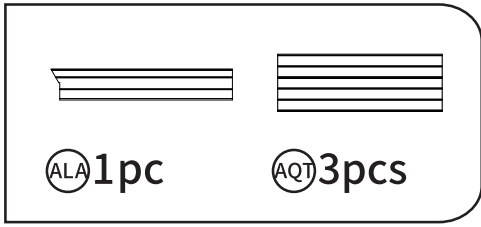

Fully fit to each other without any gap.

8

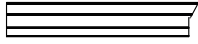

ALB 1pc

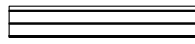

ACG 1pc

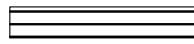

ACE 1pc



⊙ 16 pcs

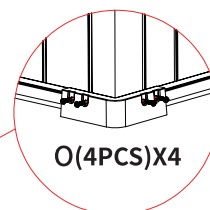
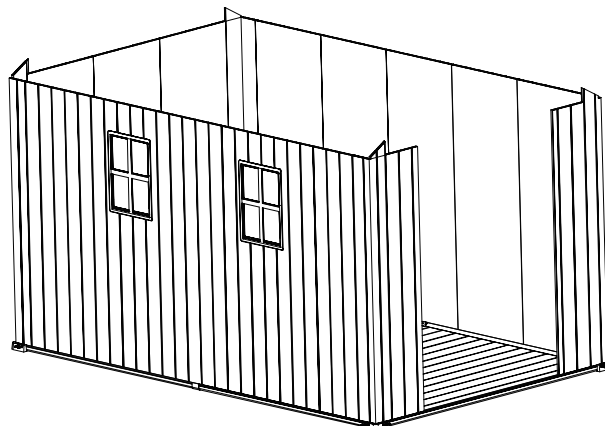
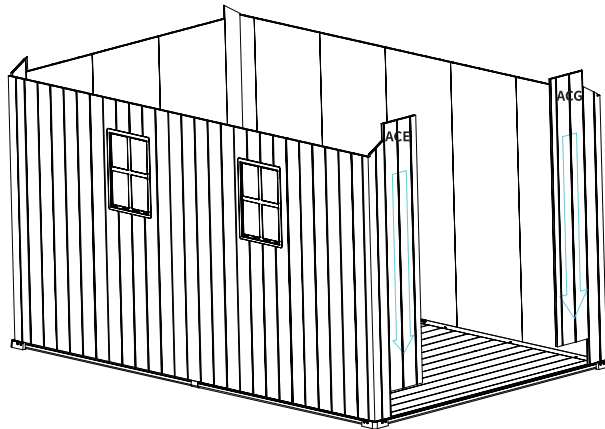
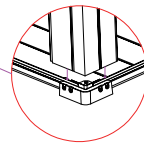
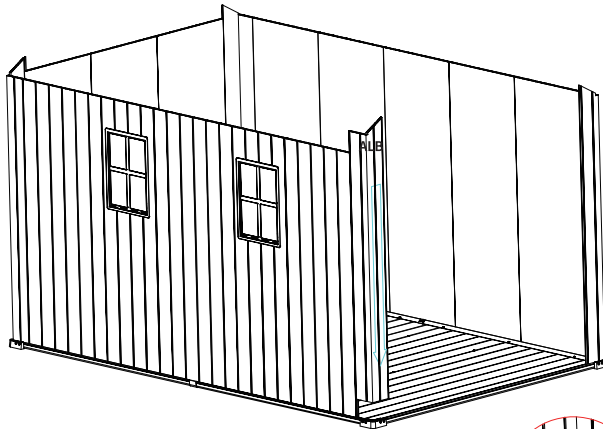
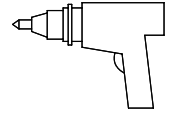

9

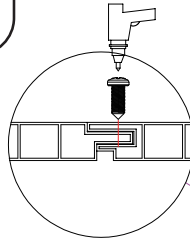
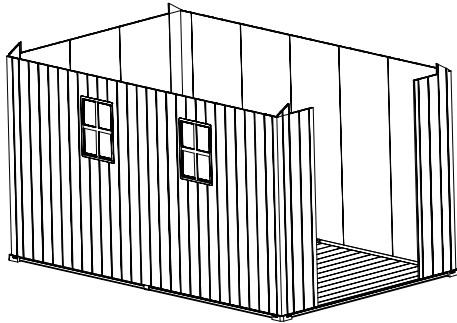
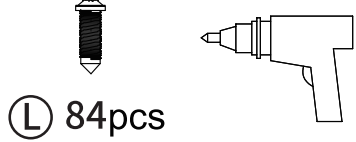

L (16PCS)

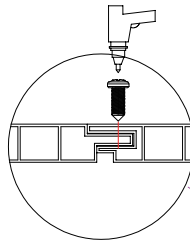
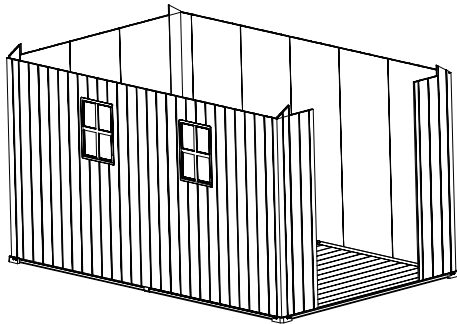
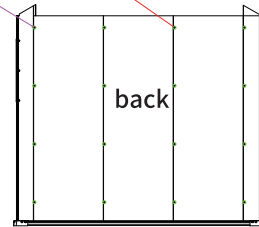

L (24PCS)

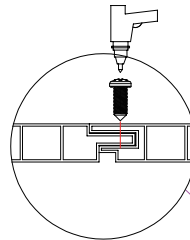
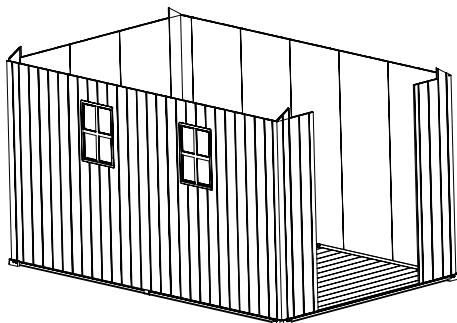
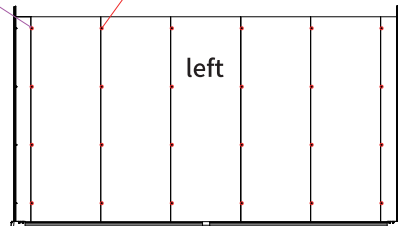

L (24PCS)

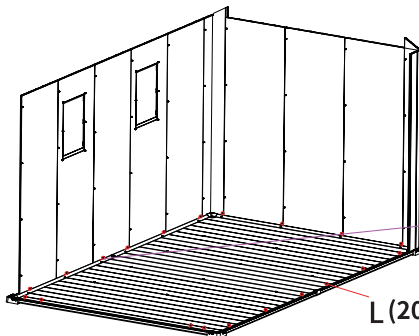
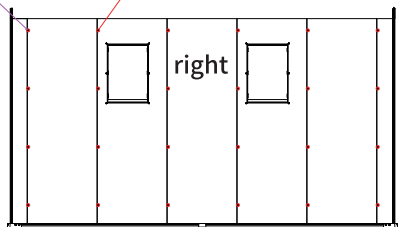

Screws fixing BHD,BHD-B,AQT,ADZ towards floor panel.

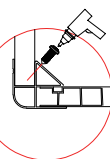

10

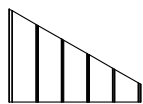

ASC 1pc

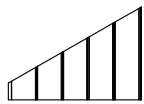

ASA 1pc

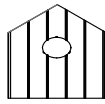

ASB 1pc



TQC 1pc



L 7pcs

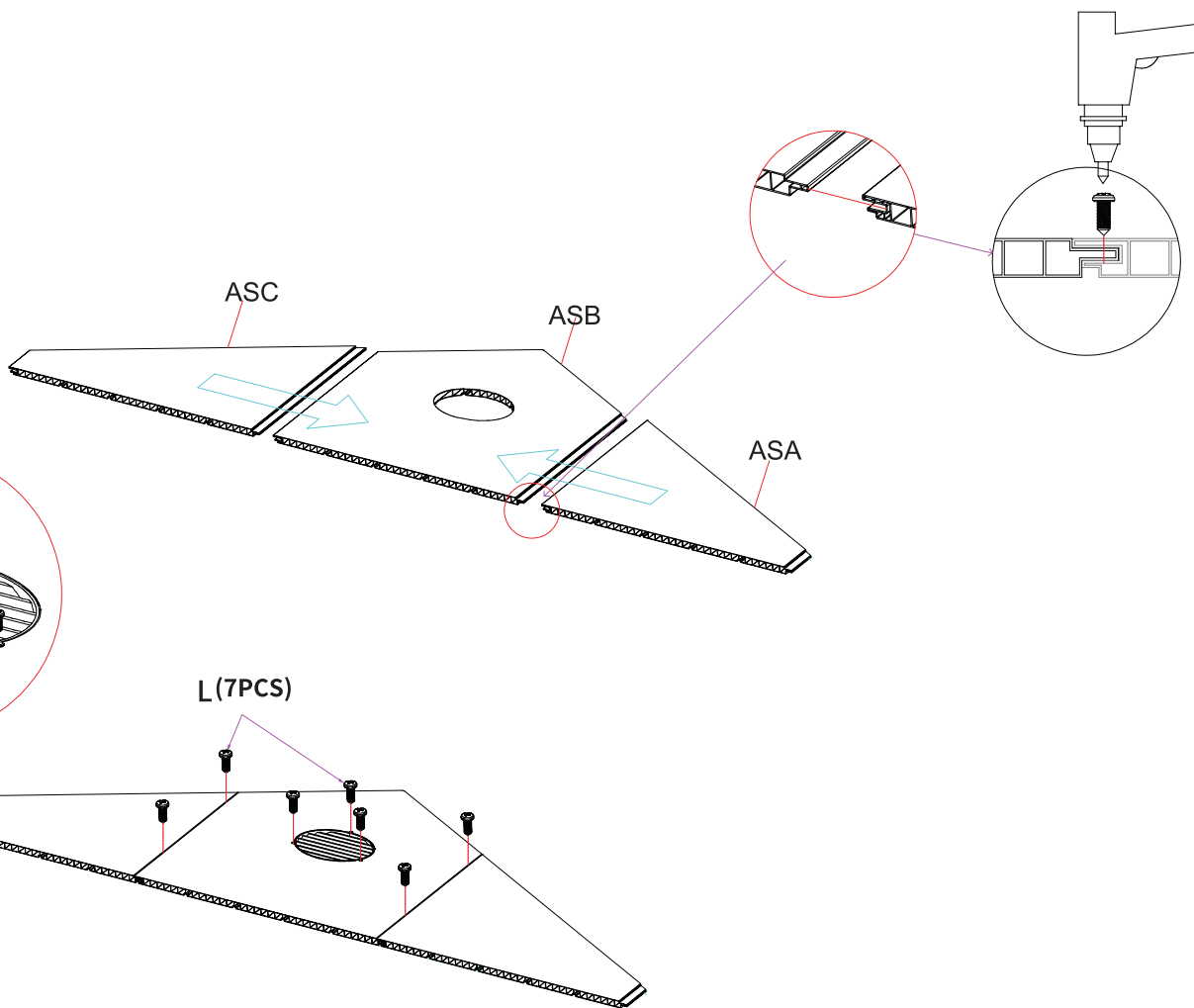
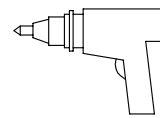

Screw fixing after fully fit.

11

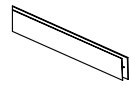

BHA 2pcs



L 24pcs

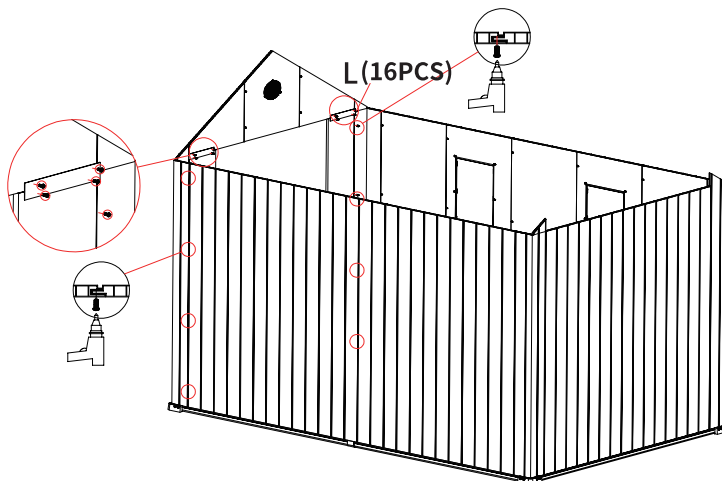
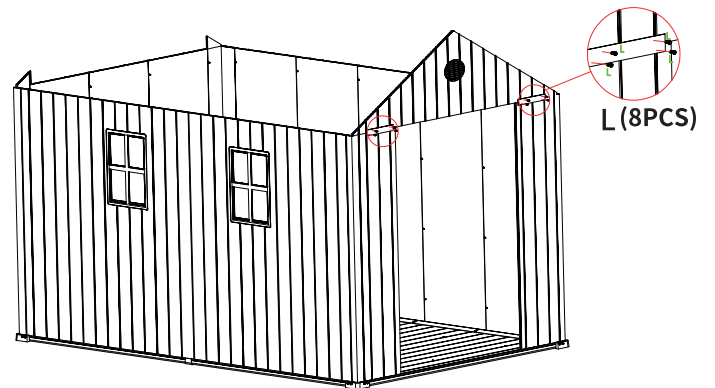
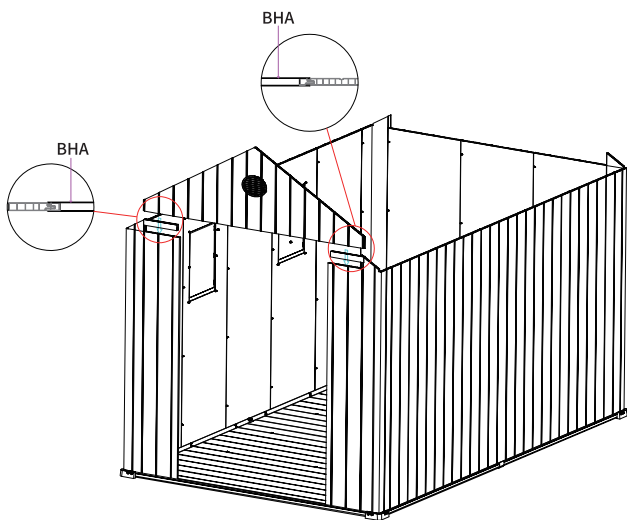
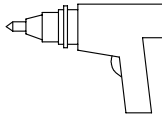

12

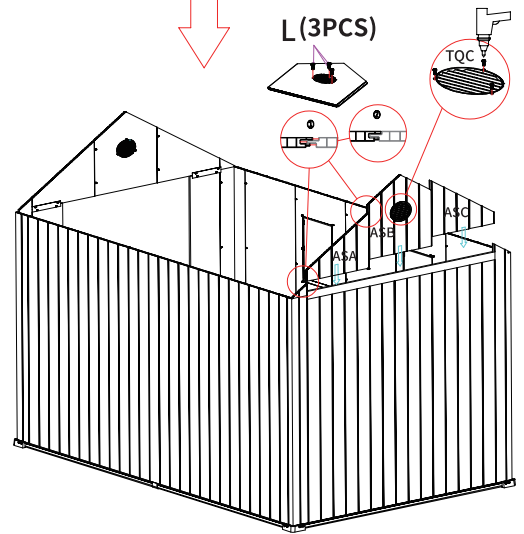
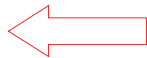
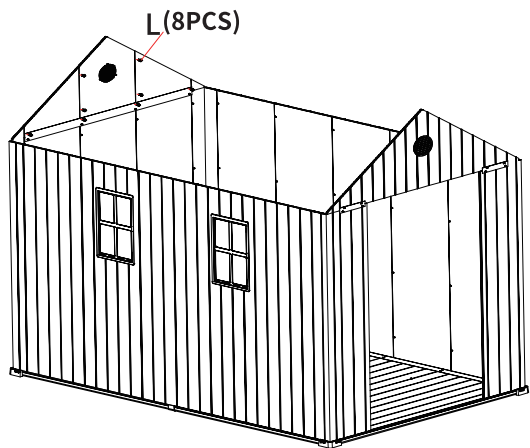
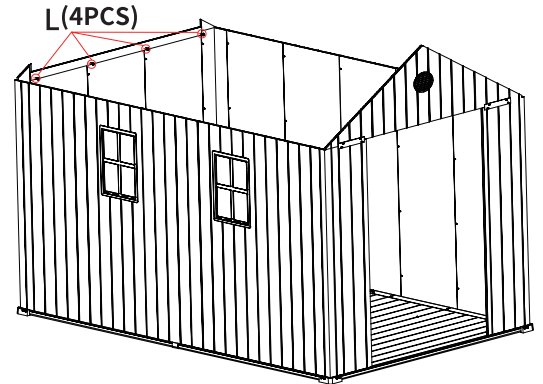
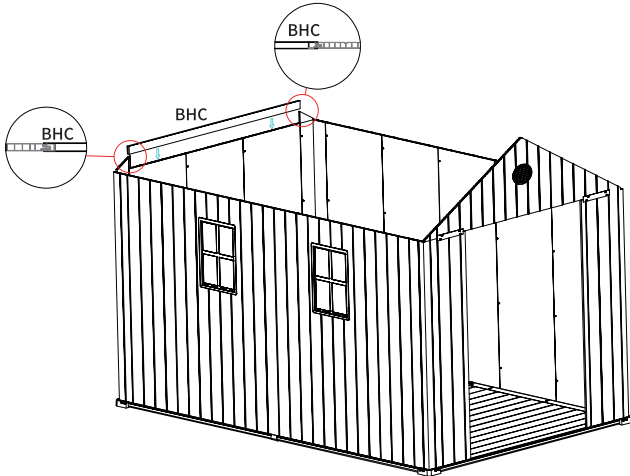
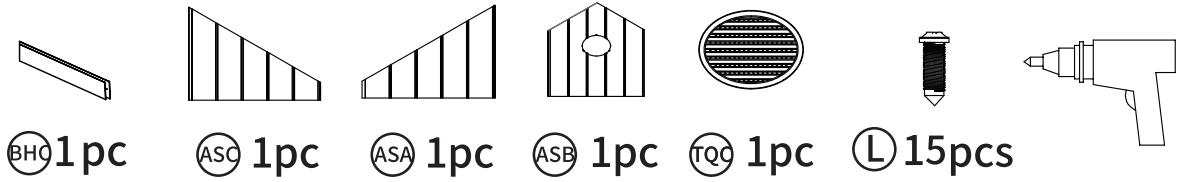

Fully fit to each other without any gap.

13

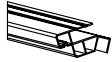

BAD-B 4pcs



BAC 2pcs



ZY-ZJ 2pcs

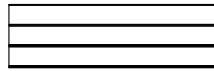

ASE 2pcs

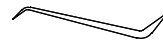

N 2pcs

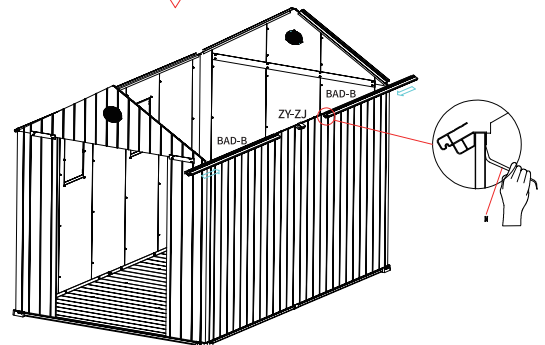
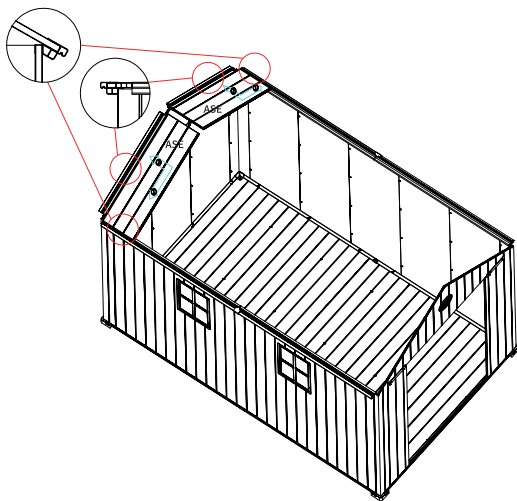
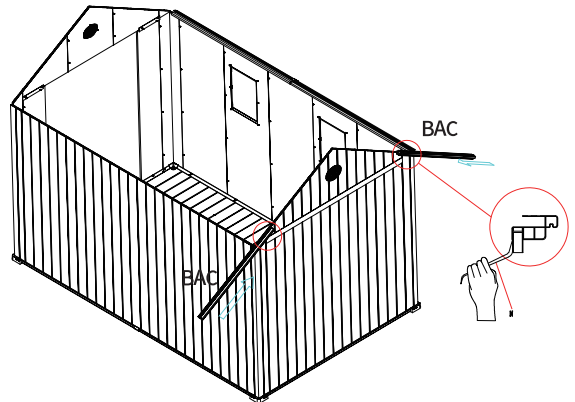
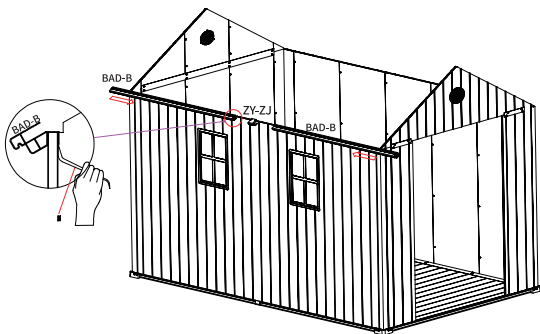

14

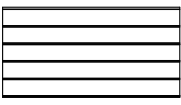

ASD 2pcs

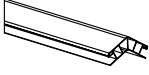

BAE-B 1pc



L 4pcs

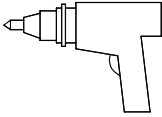



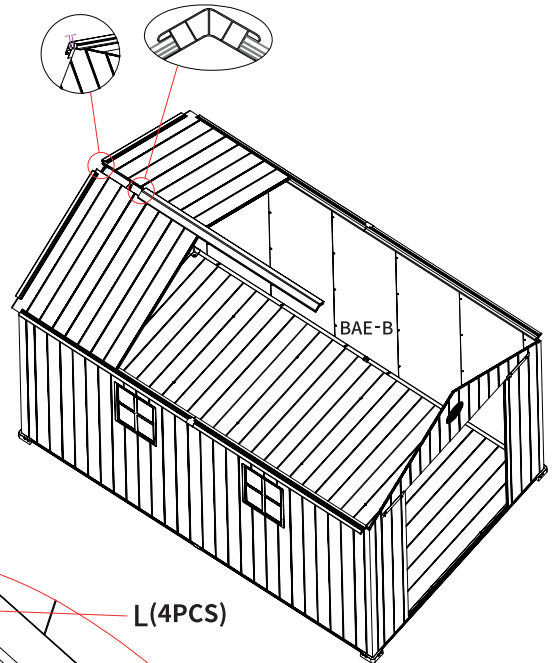
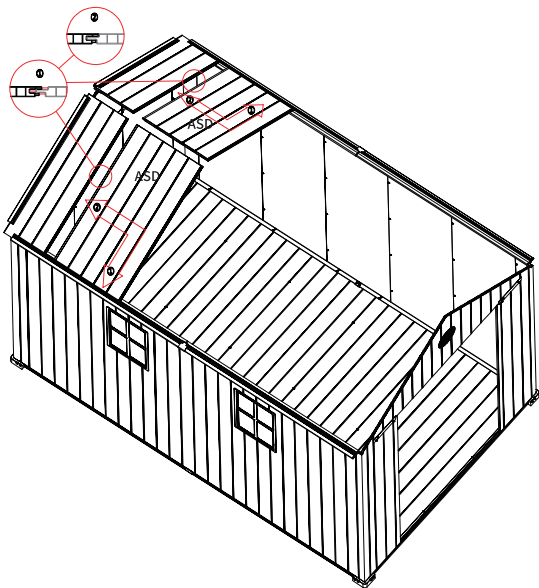

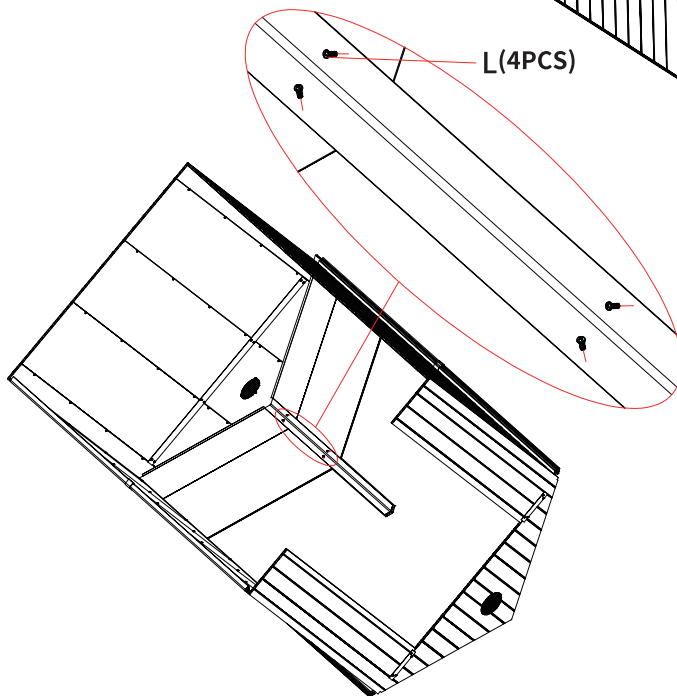

Fully fit to each other without any gap.

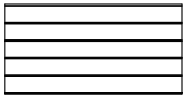

15



ASD 2pcs



L 34pcs

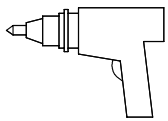



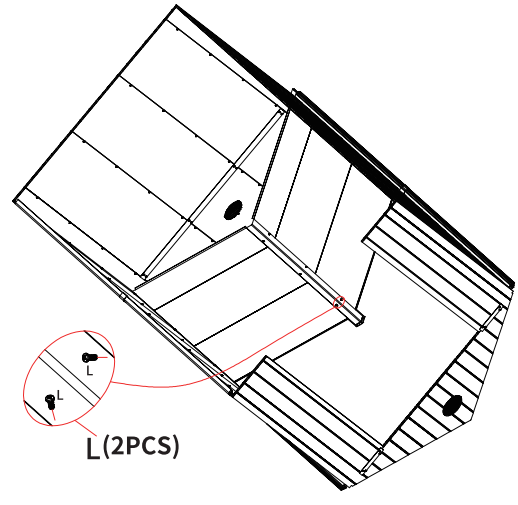
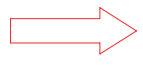
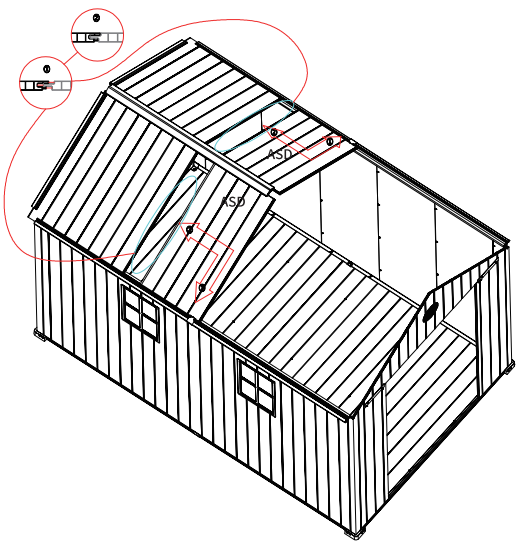

Fully fit to each other without any gap.

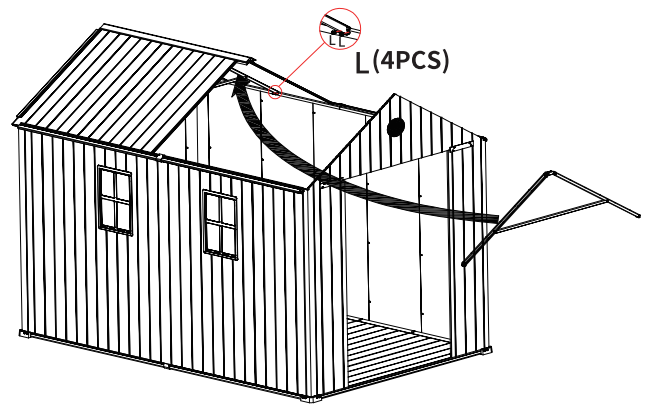
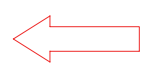
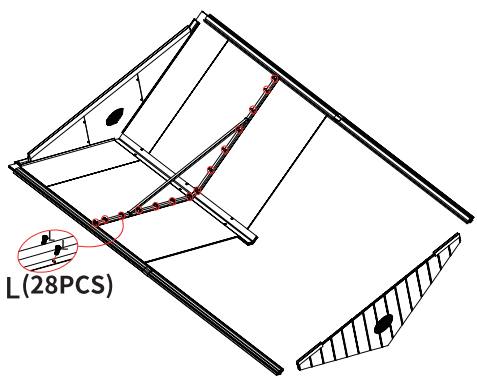

Fixing Roof Support to the roof.

16

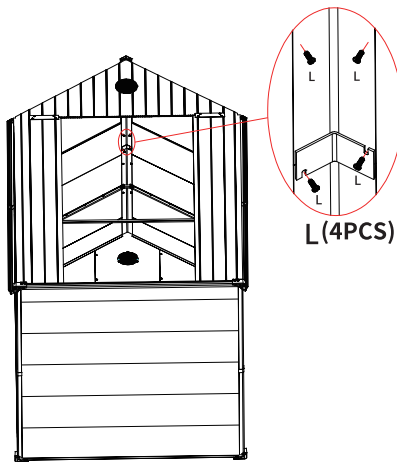
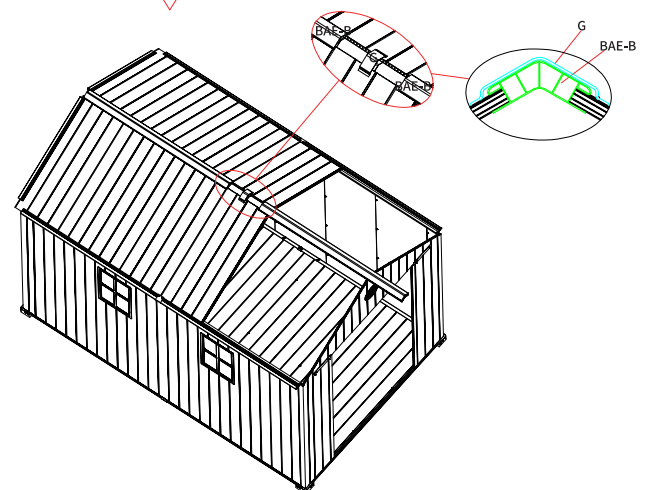
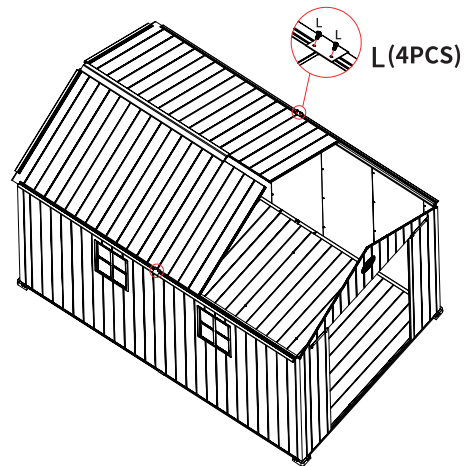
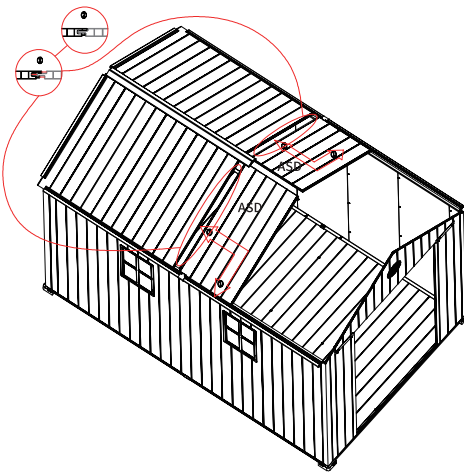
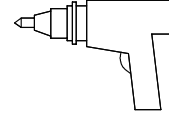
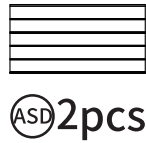
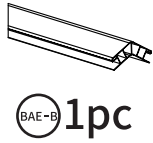

17

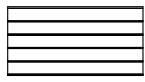

ASD 2pcs



L 34pcs

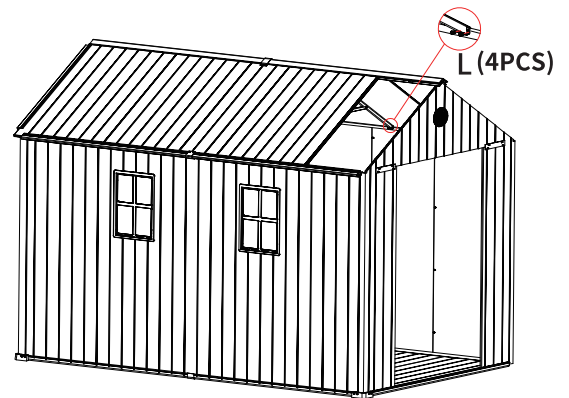
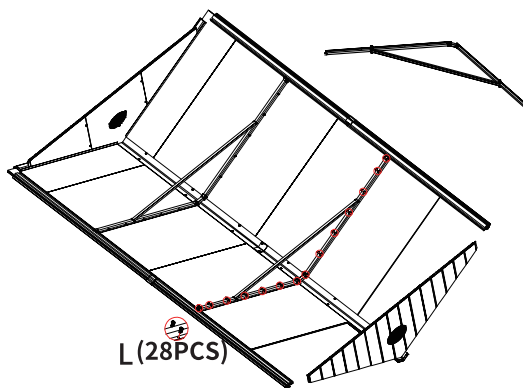
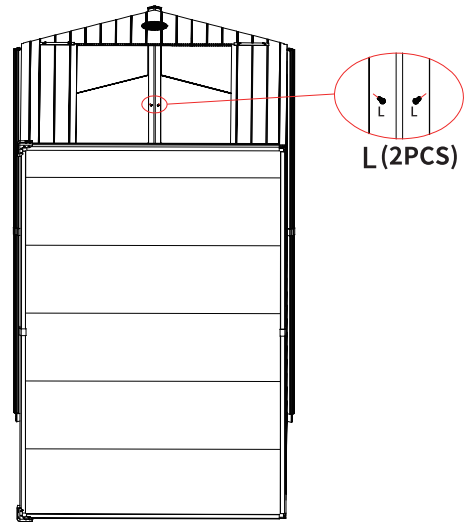
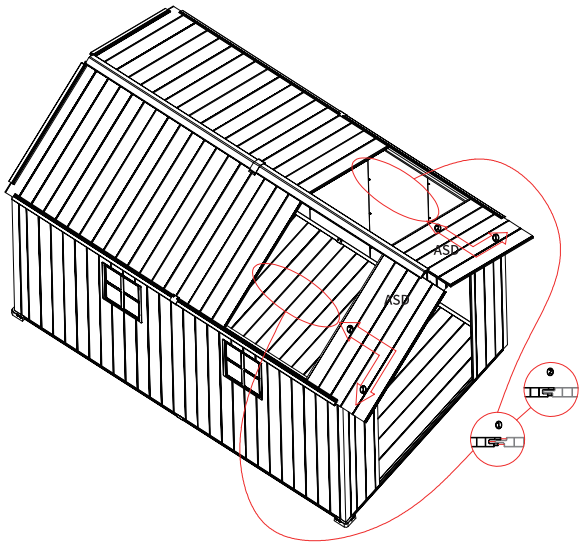
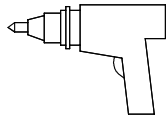

18

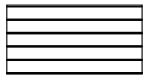

ASD 2pcs

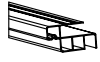

BAC 2pcs



L 2pcs

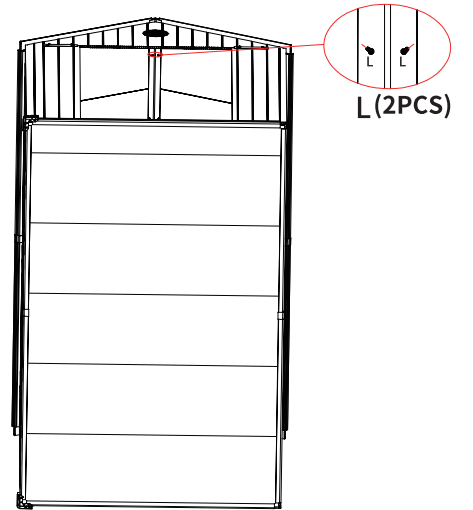
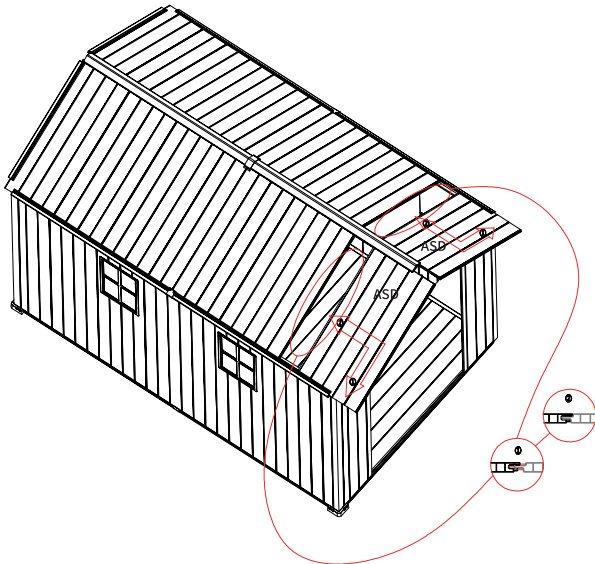
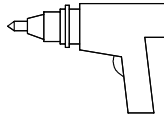

Fully fit to each other without any gap.

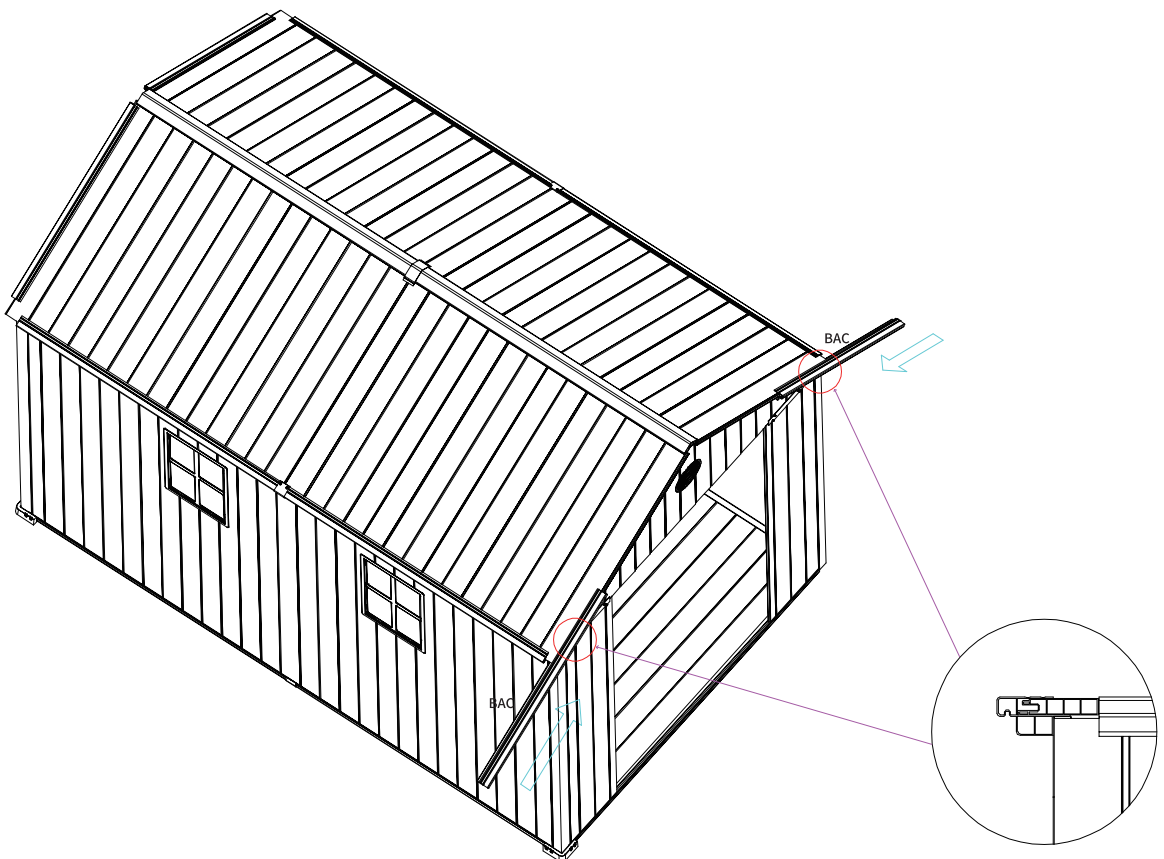

19

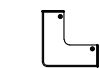

DCT 4pcs



CC 2pcs



L 74 pcs

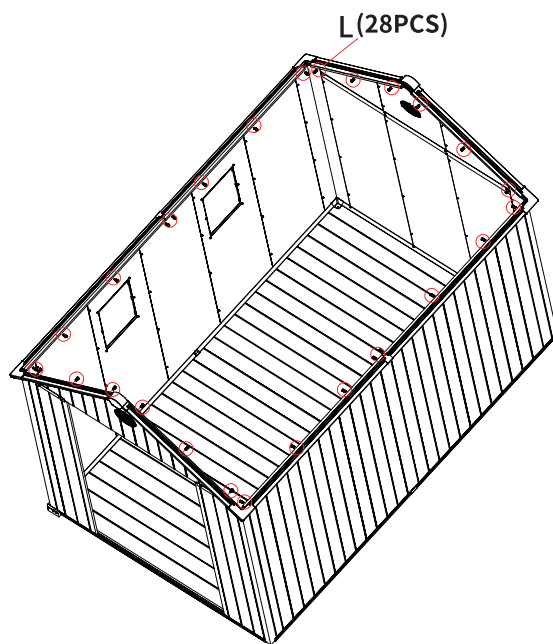
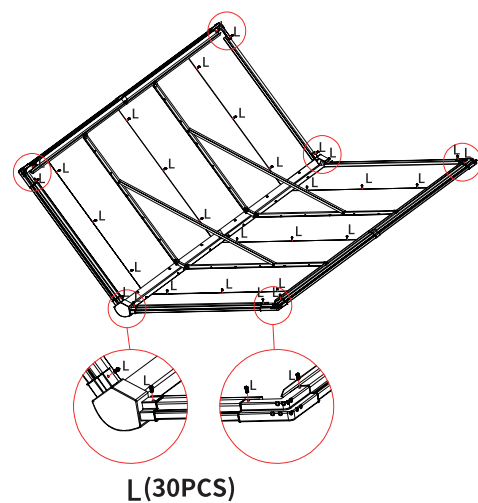
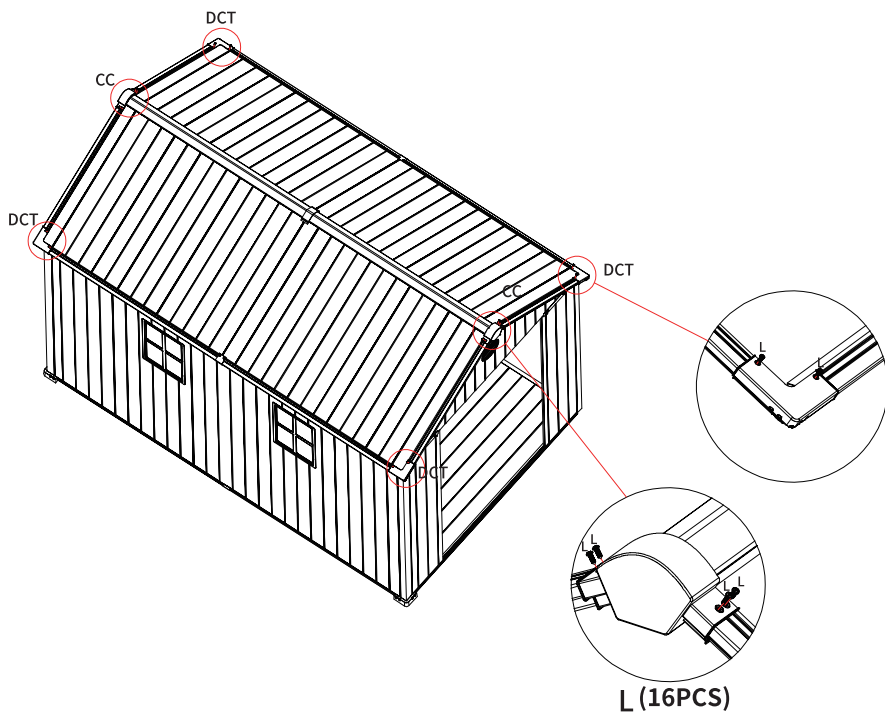
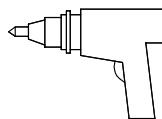

20

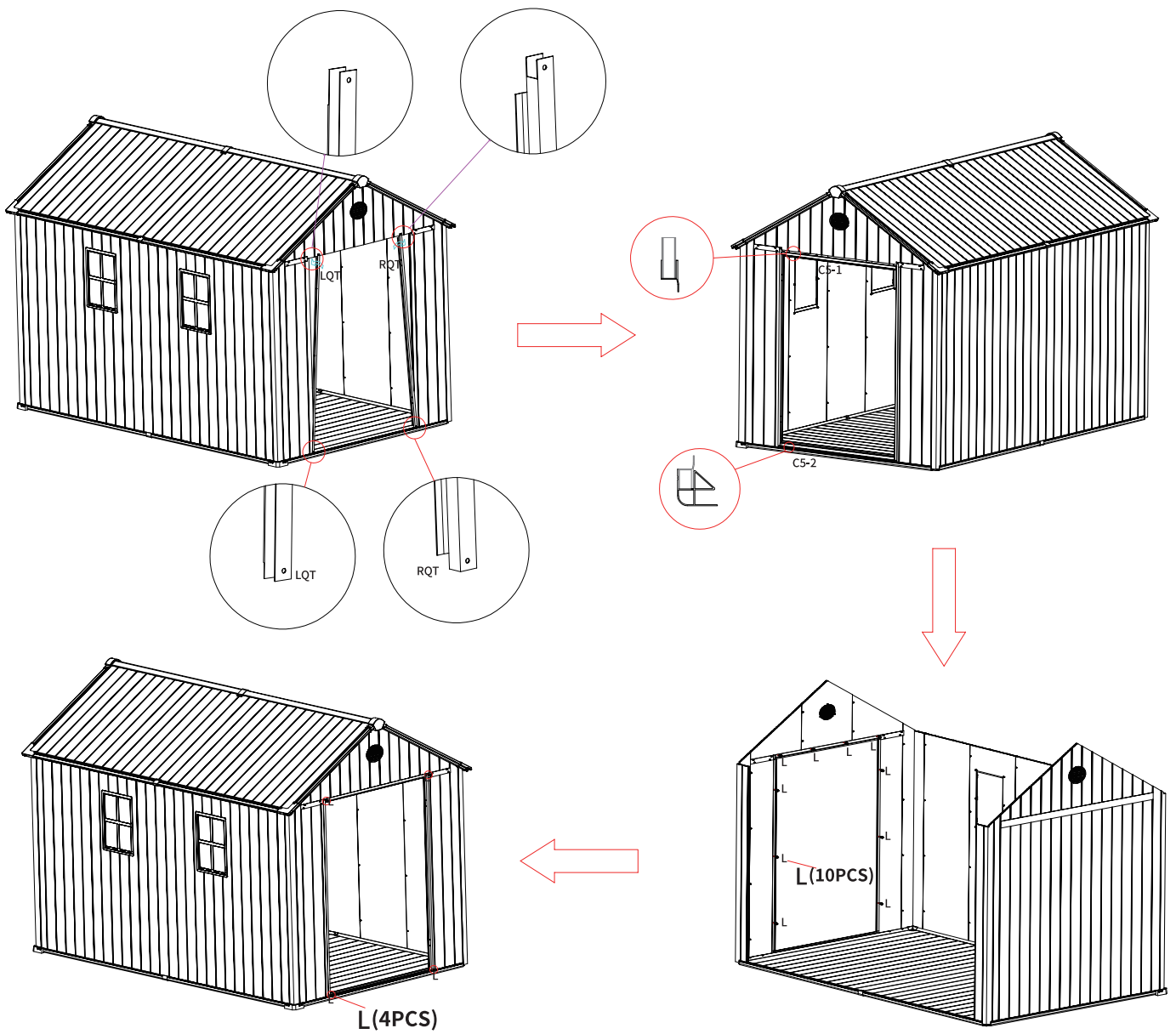
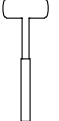
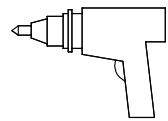
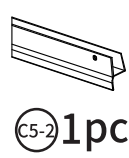
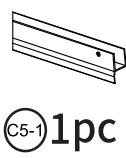
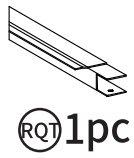
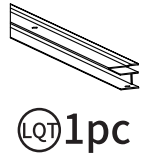

21

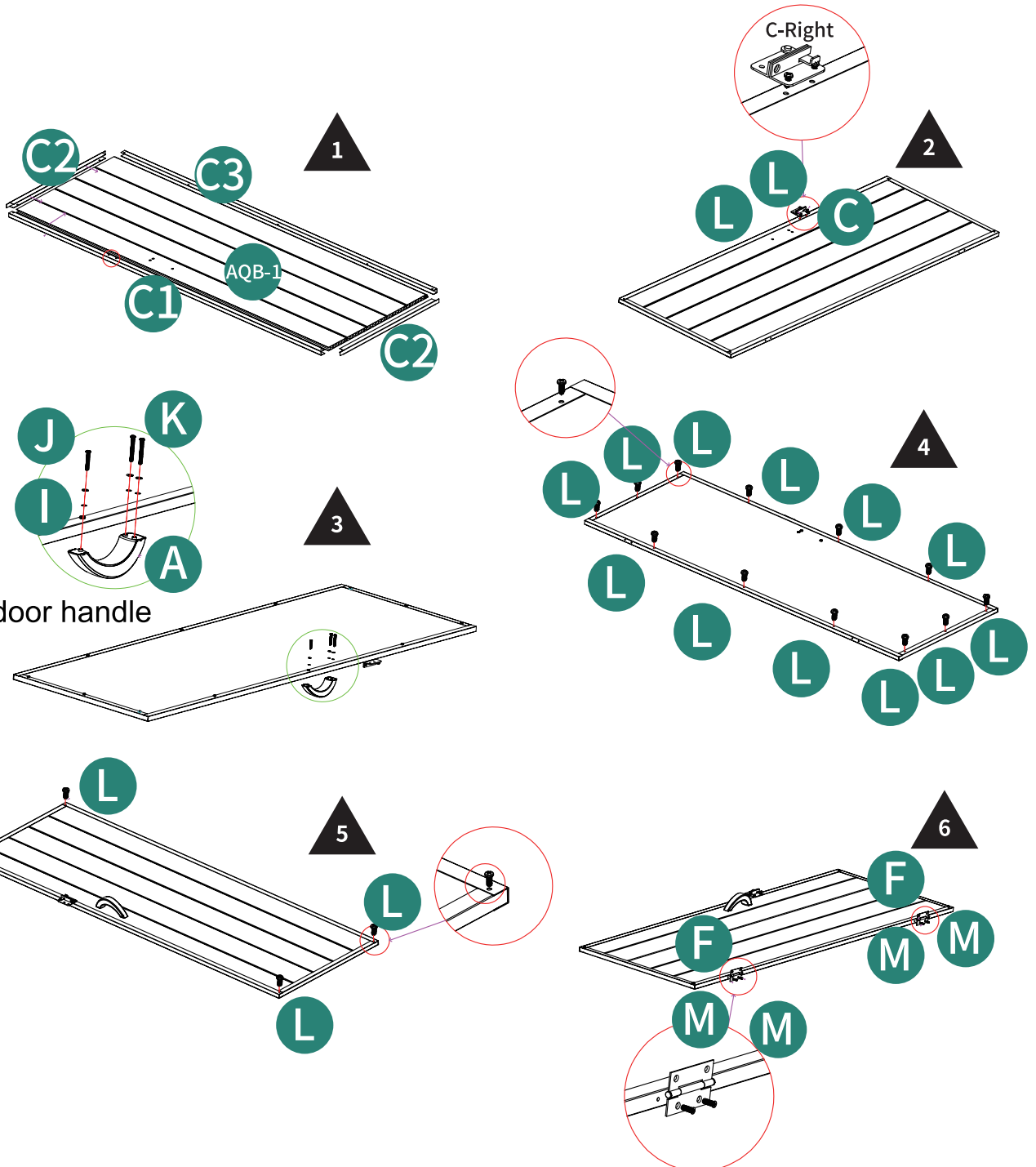
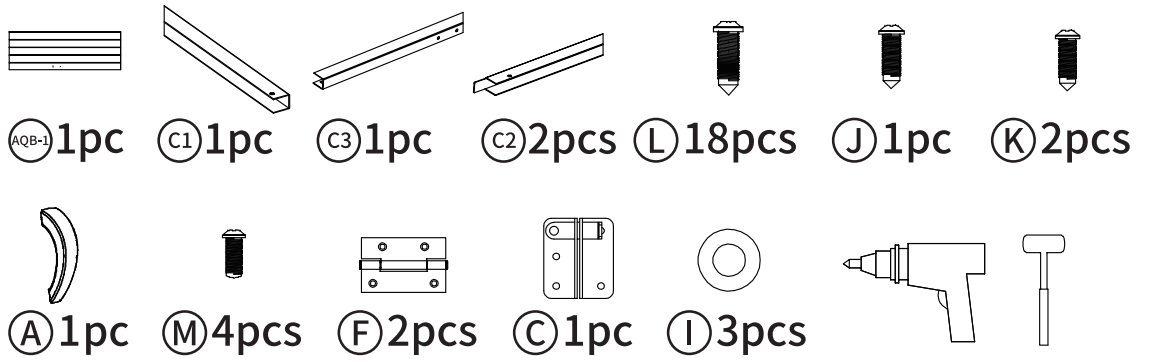

22

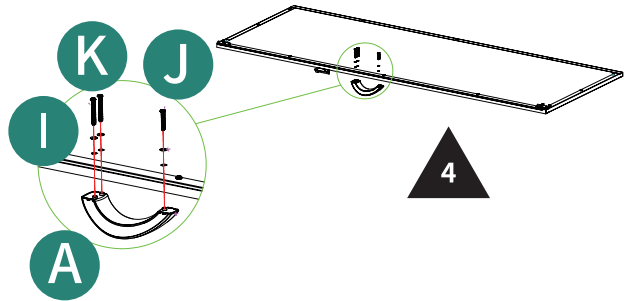
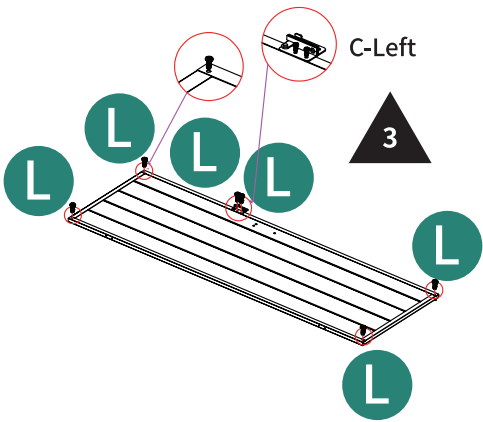
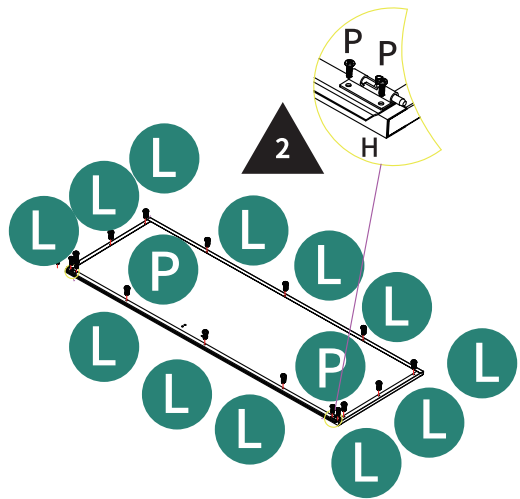
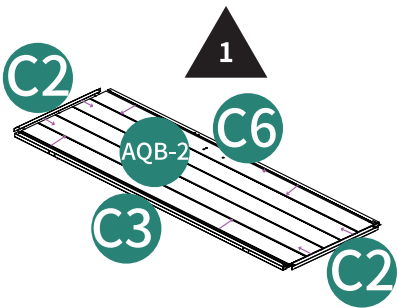
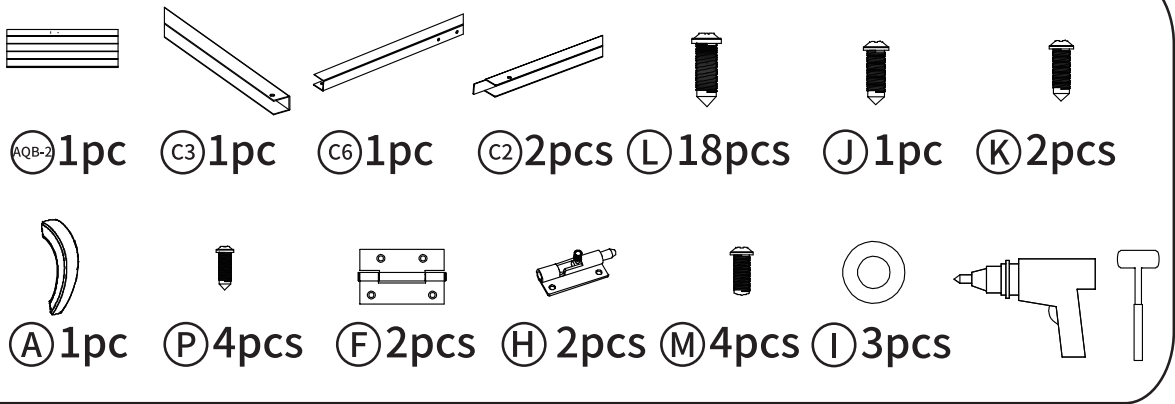

Fixing door handle

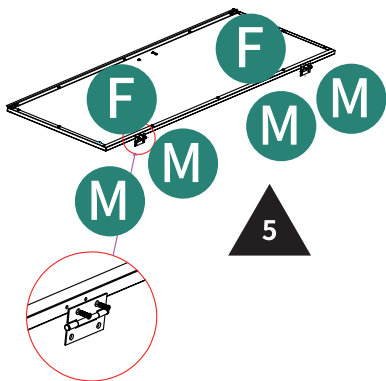

23

Ⓜ 8pcs

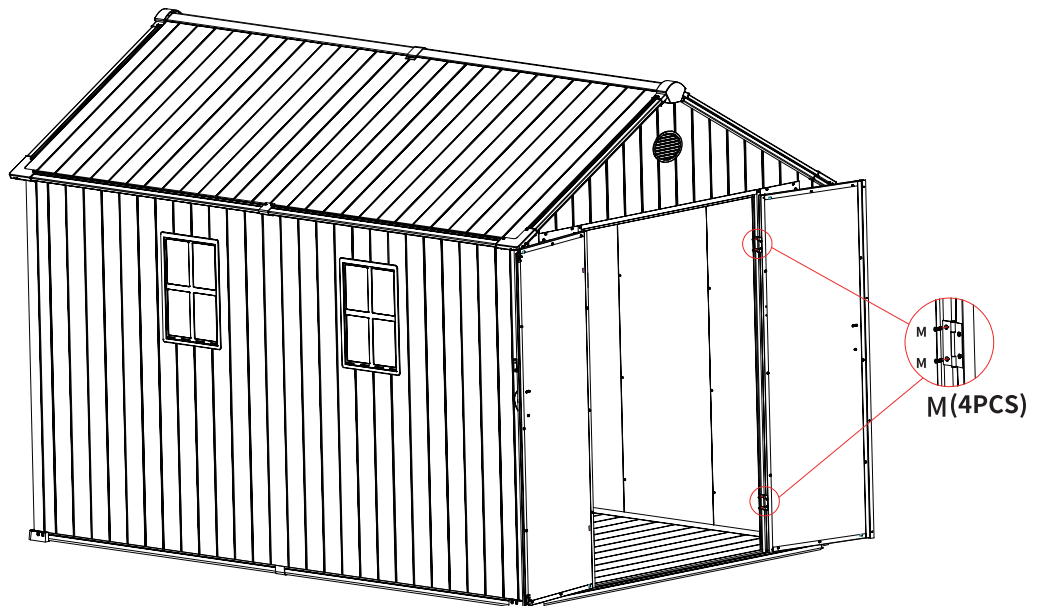
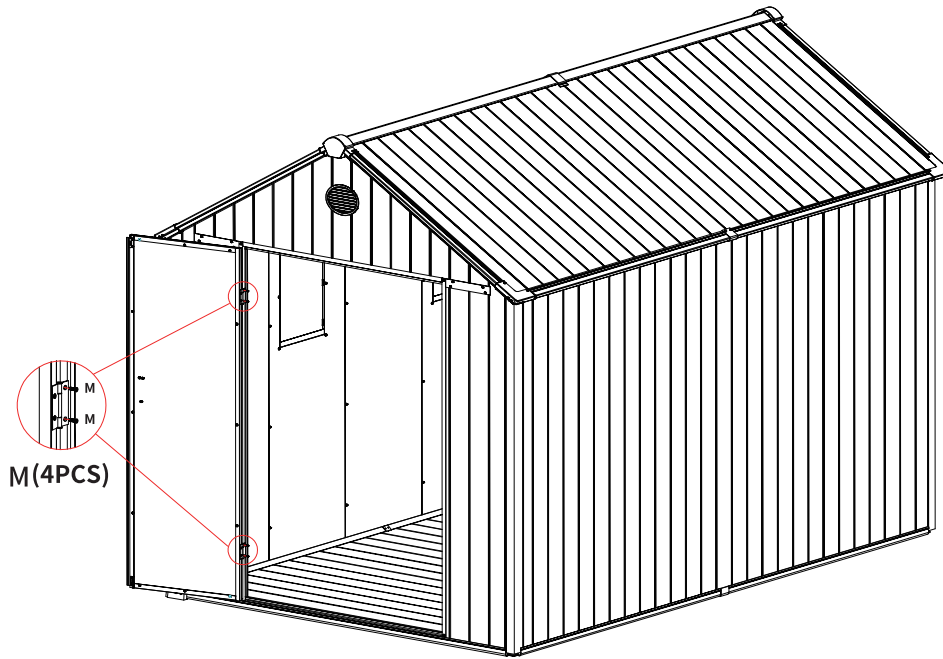
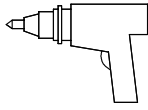

24



ⓑ 8pcs



Ⓛ 64pcs



Ⓢ 8pcs



Ⓣ 8pcs

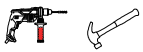
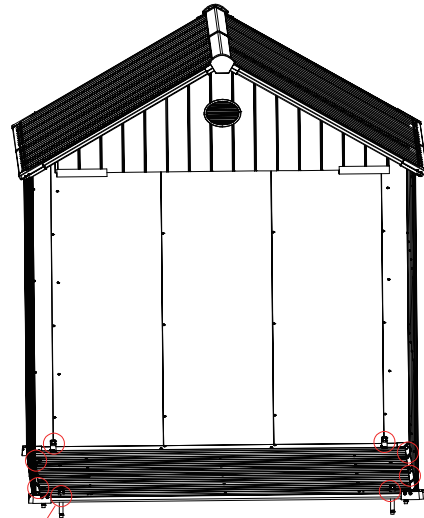
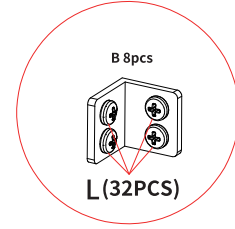
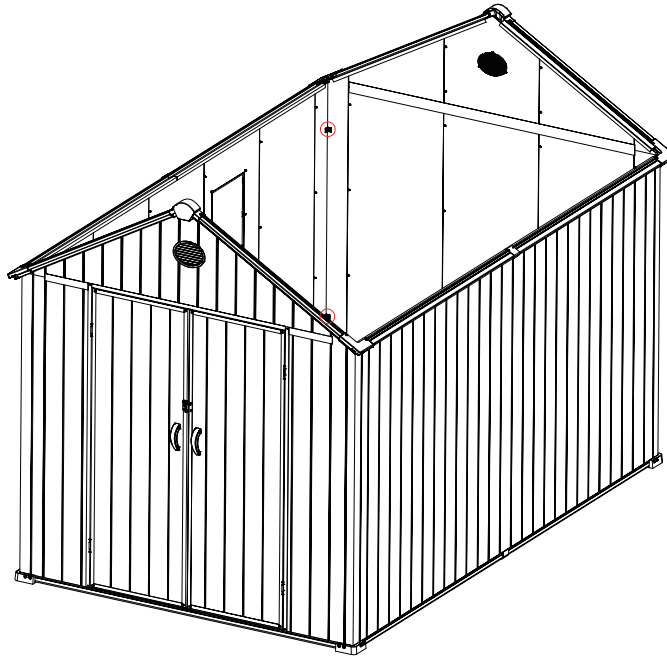
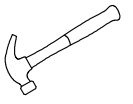
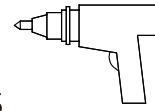

Ⓛ (32PCS)

Ⓣ (8PCS)

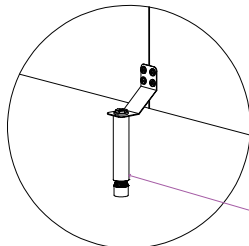
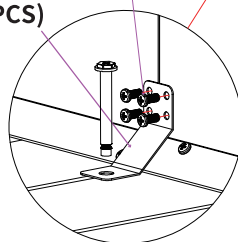

Ⓢ (8PCS)

25

