

Assembly Instructions

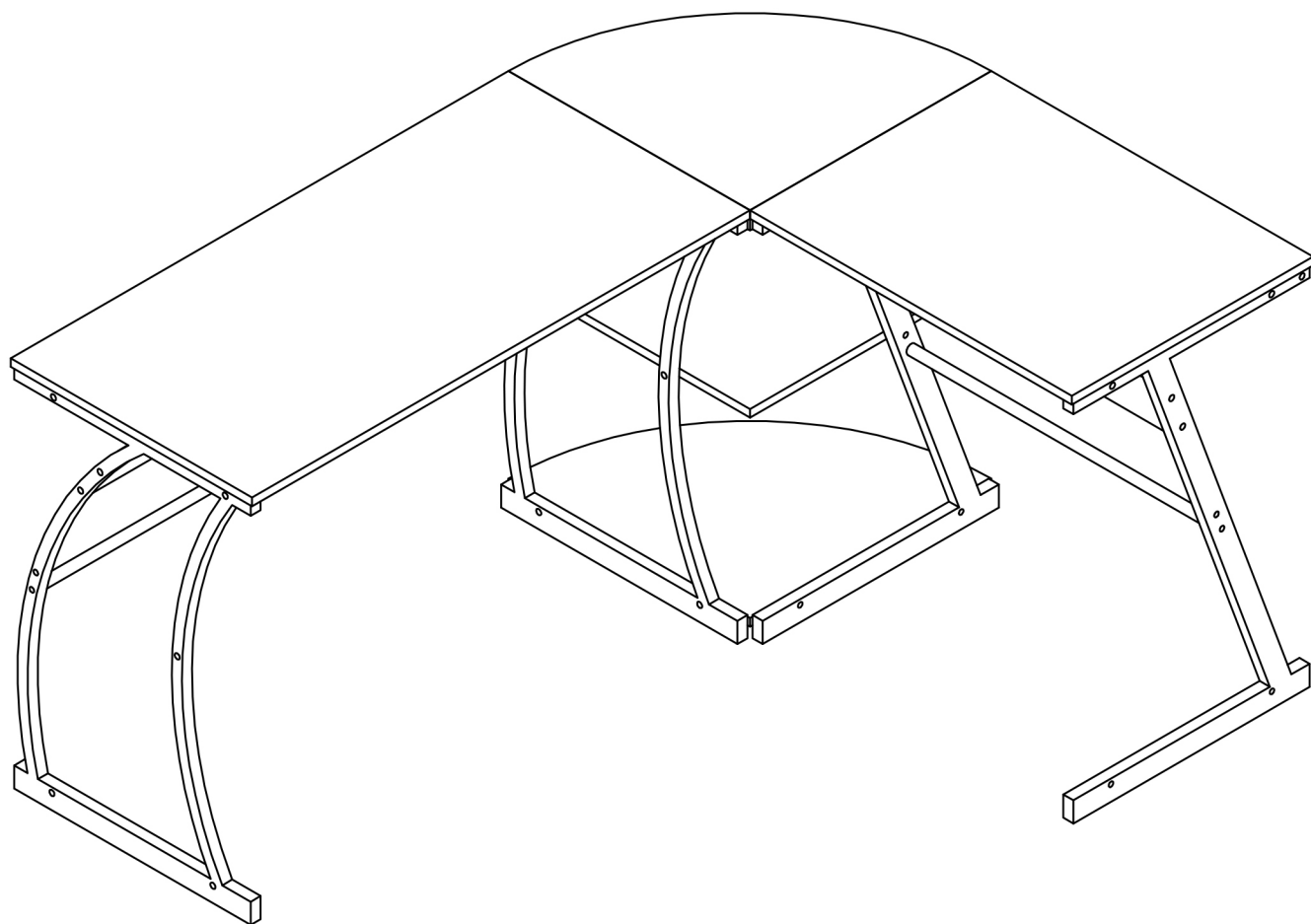

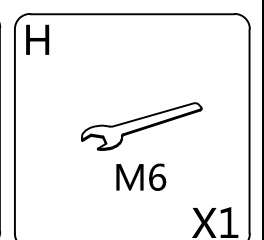

1

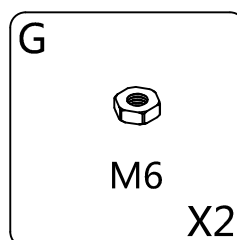
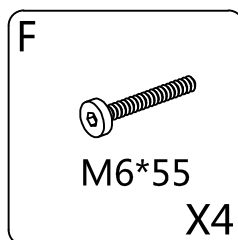
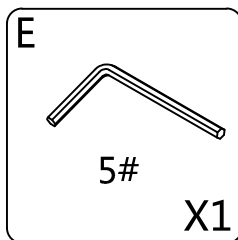
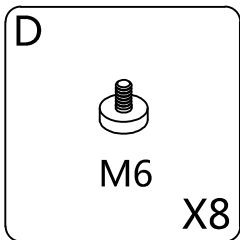
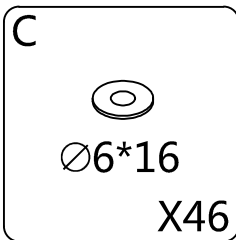
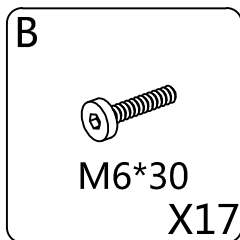
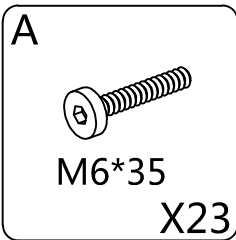
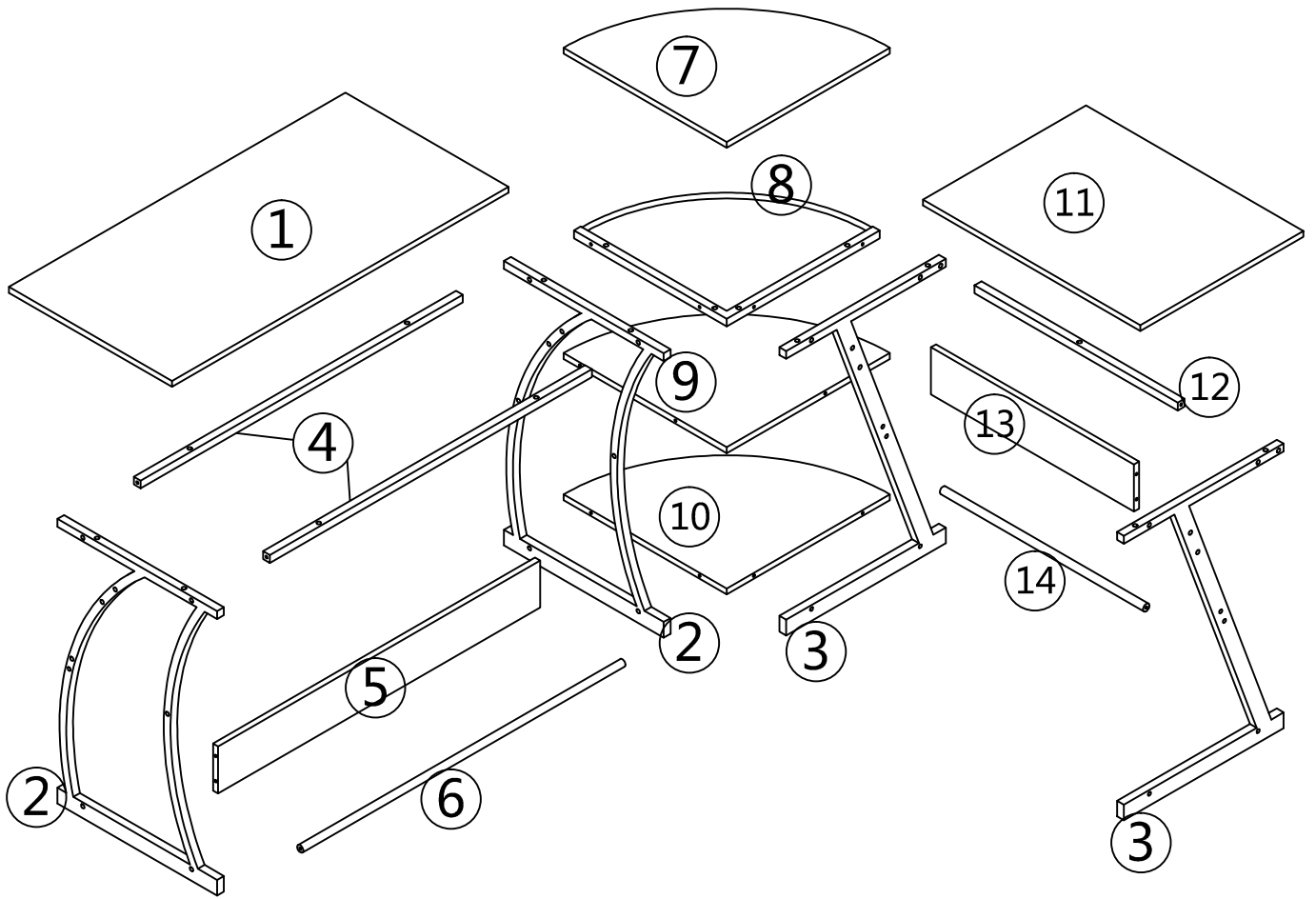
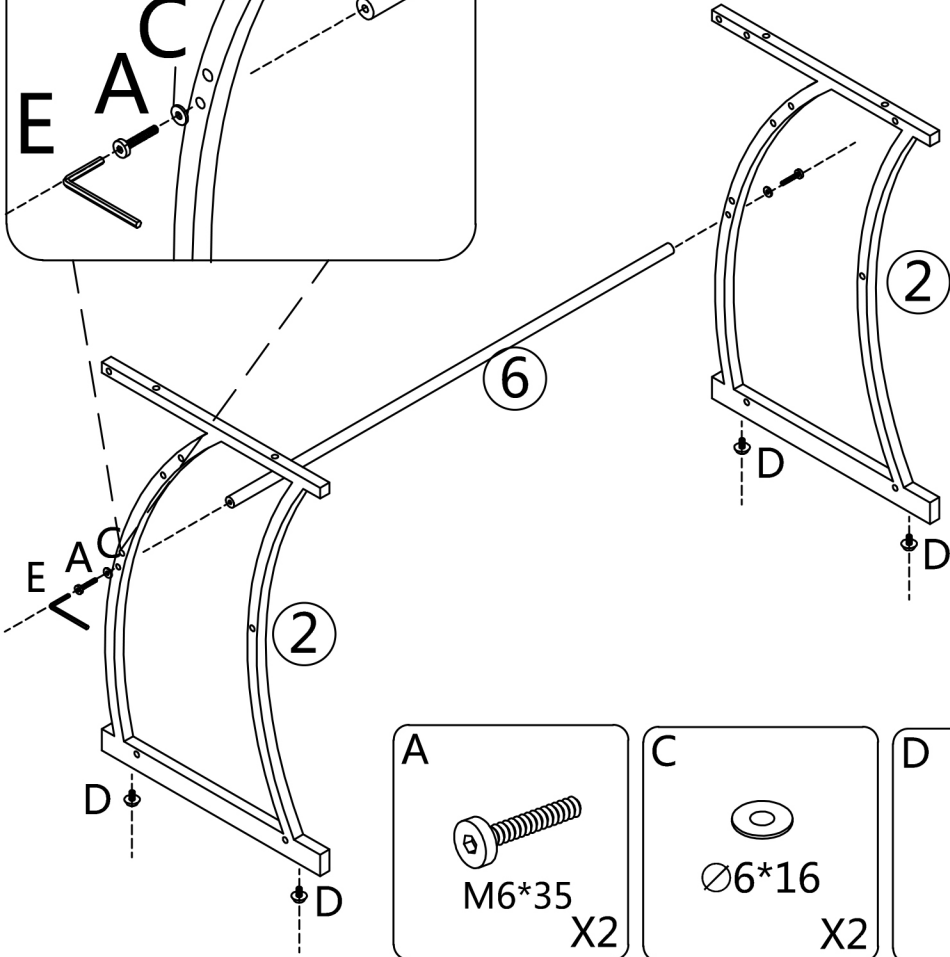
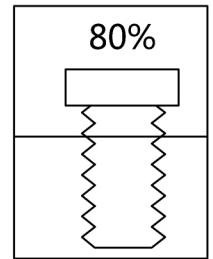
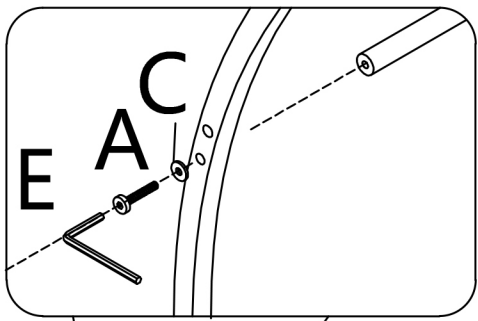

Use screw A to connect the two No. 2 legs with a No. 6 round tube, and then use screws to 80%, two No. 2 legs bottom screw D

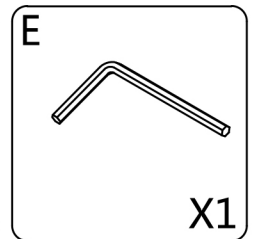
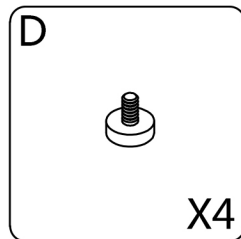
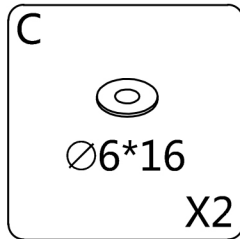
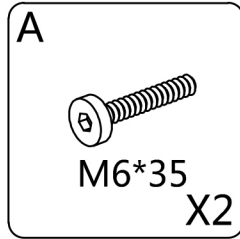

2

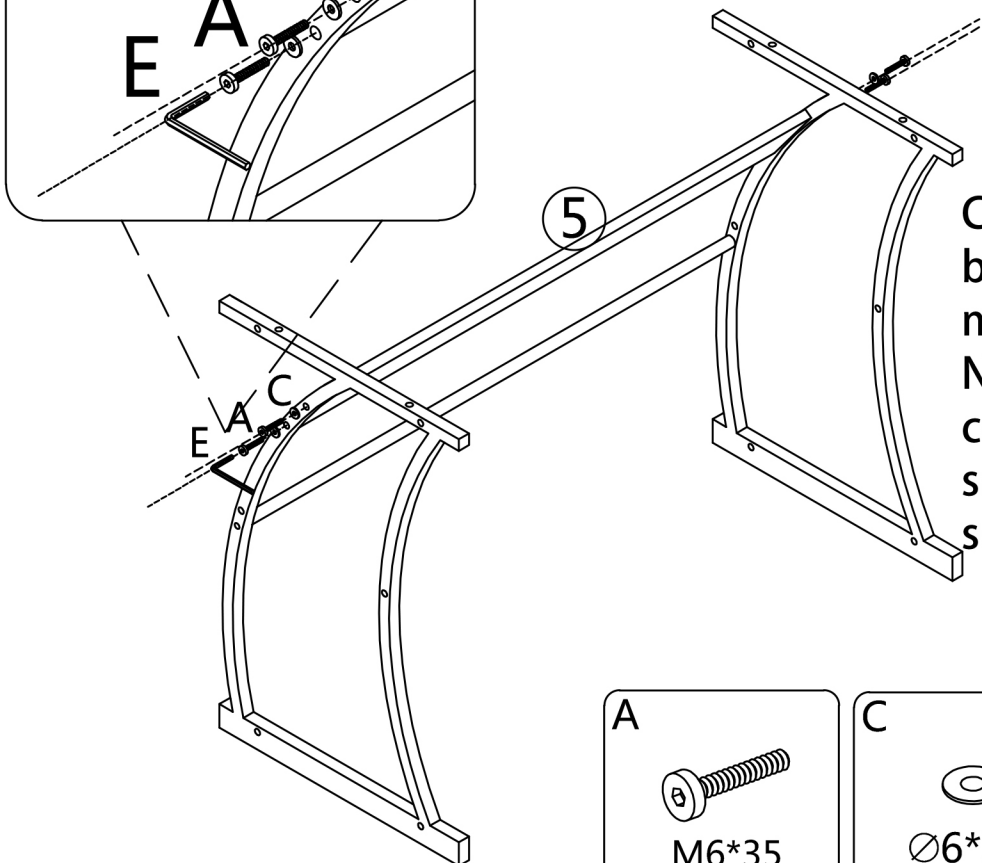
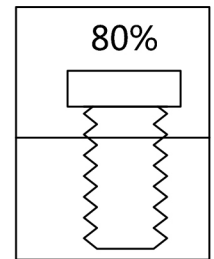
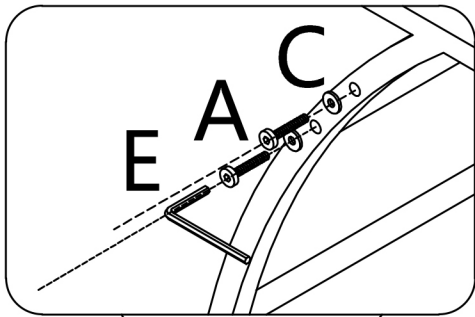

Connect the No. 5 board to the middle of the two No. 2 legs, then connect with screw A, and screw it to 80%

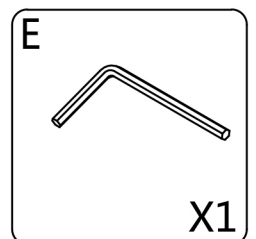
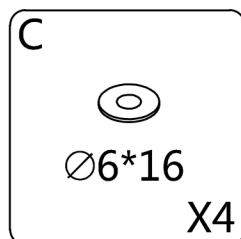
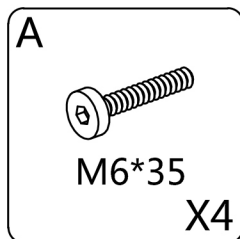

3

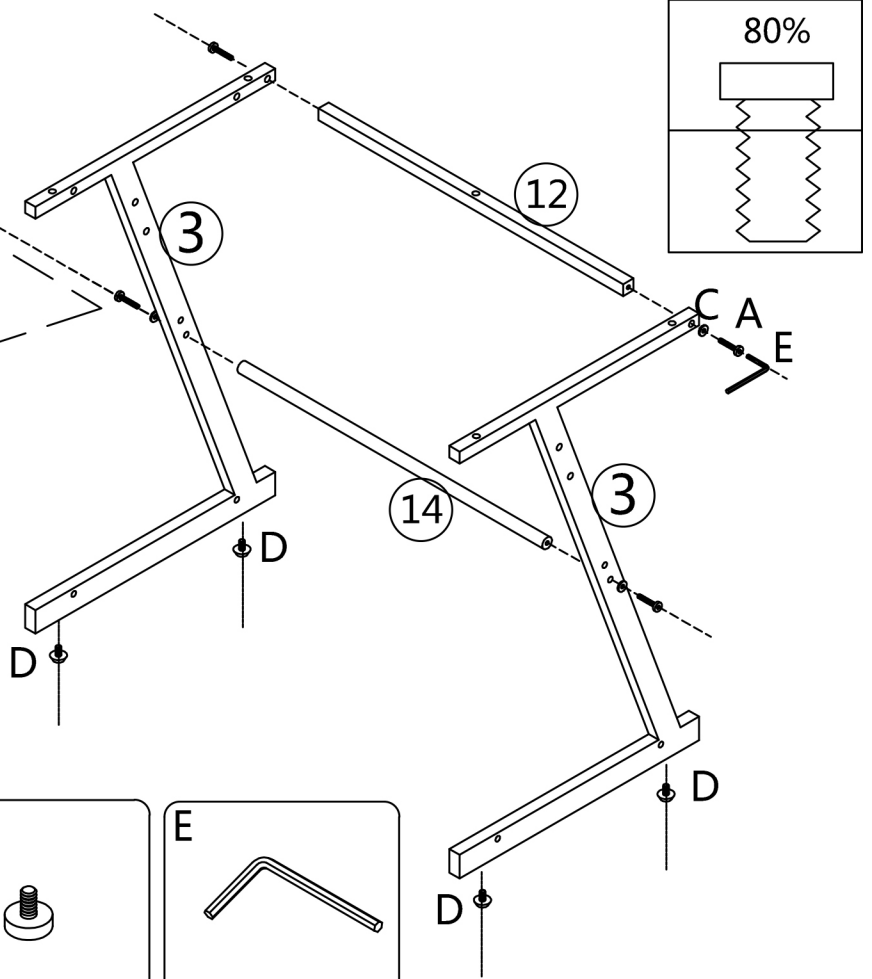
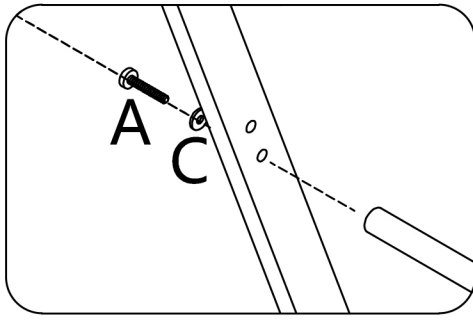

Connect No. 12 and No. 14 to the two No. 3 legs, connect with screw A, and screw D at the bottom of the two No. 3 legs to 80%

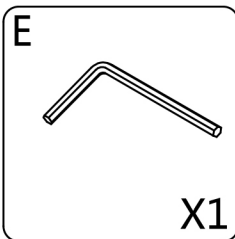
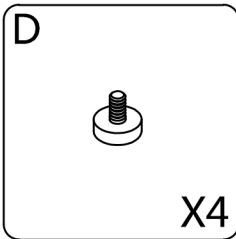
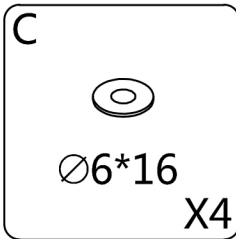
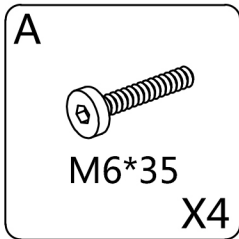

4

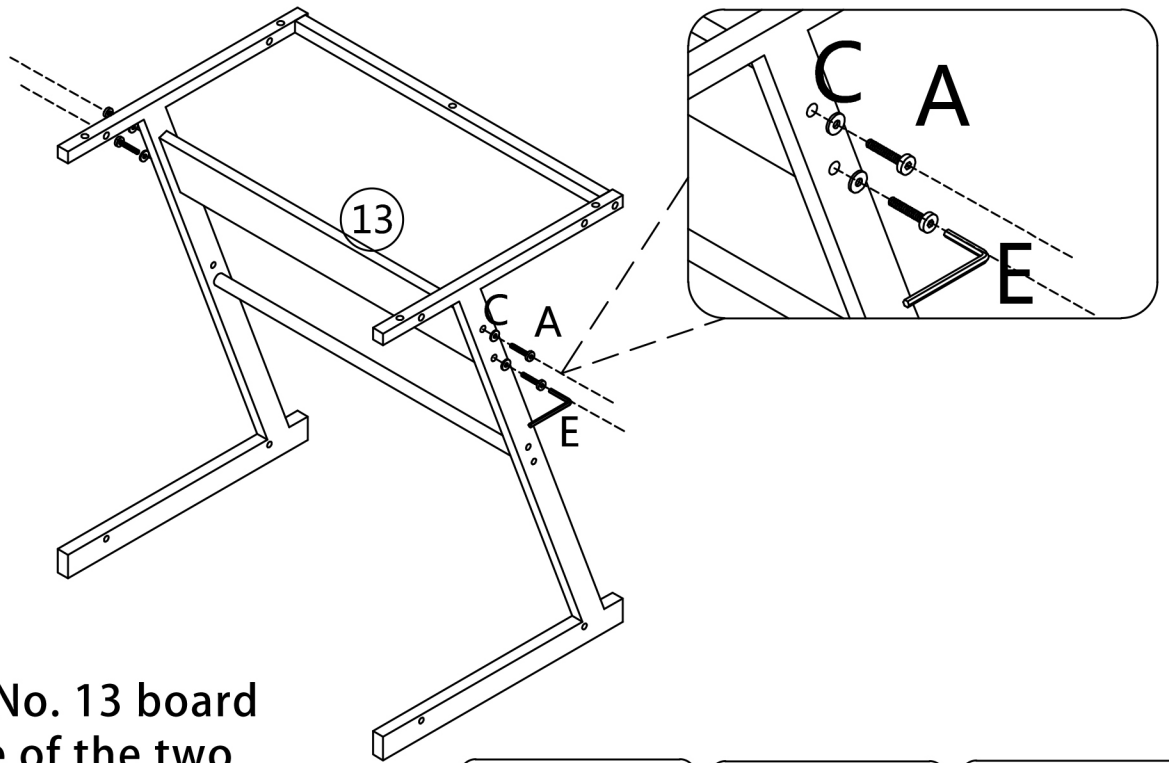
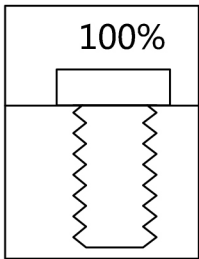

Connect the No. 13 board to the middle of the two No. 3 legs, connect with screw A, and tighten the screw to 100%

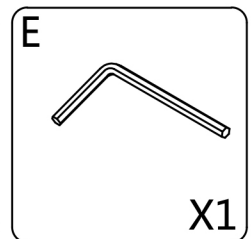
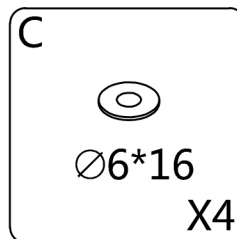
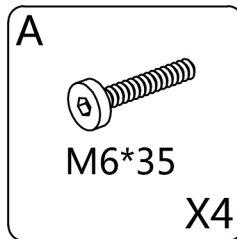

5

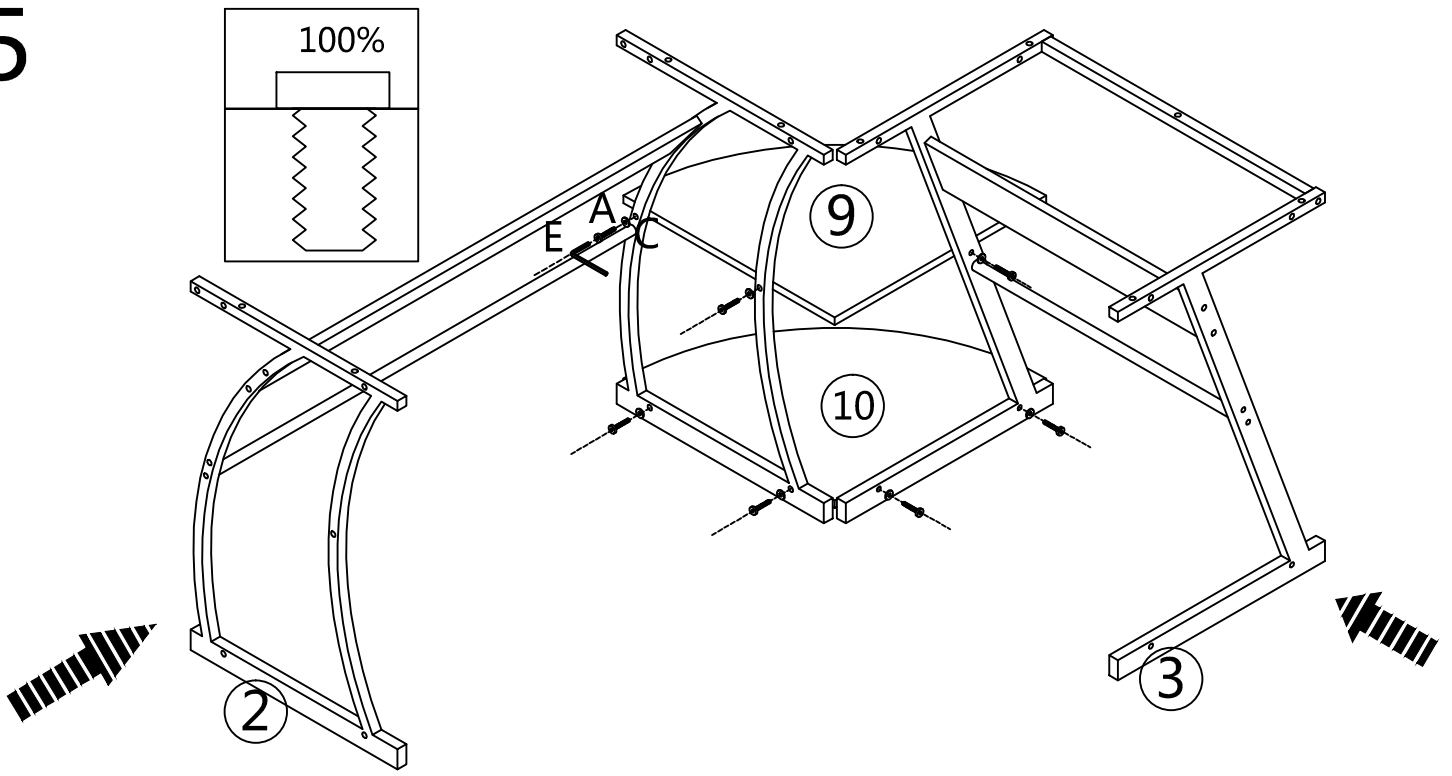

Use screw A to connect the No.9 and No.10 boards to the No.2 and No.3 legs, and tighten the screws to 100%

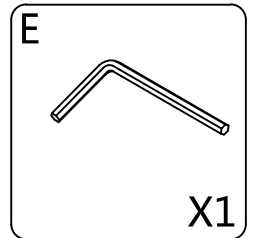
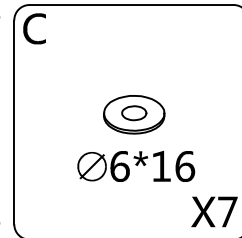
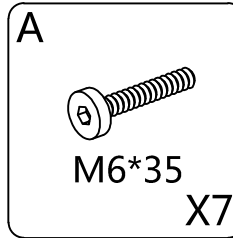

6

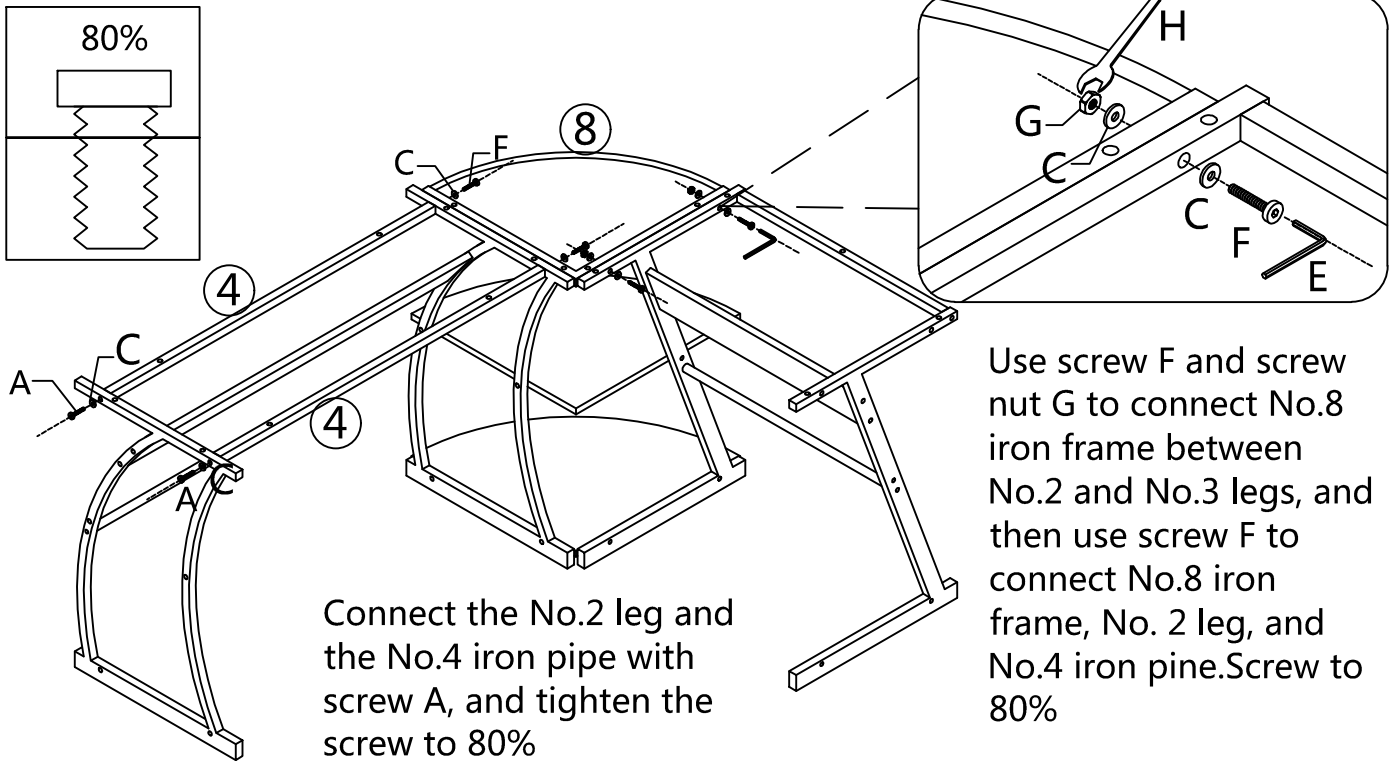

Connect the No.2 leg and the No.4 iron pipe with screw A, and tighten the screw to 80%

Use screw F and screw nut G to connect No.8 iron frame between No.2 and No.3 legs, and then use screw F to connect No.8 iron frame, No. 2 leg, and No.4 iron pine.Screw to 80%

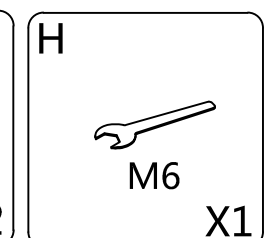
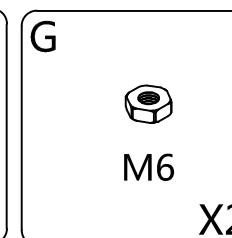
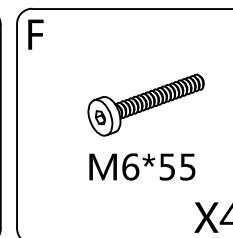
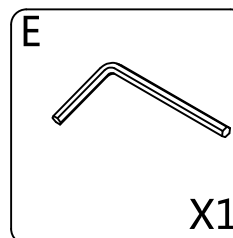
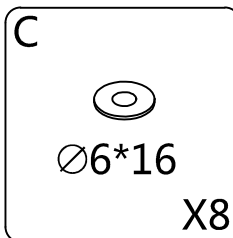
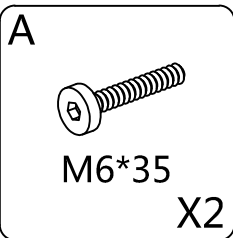

7

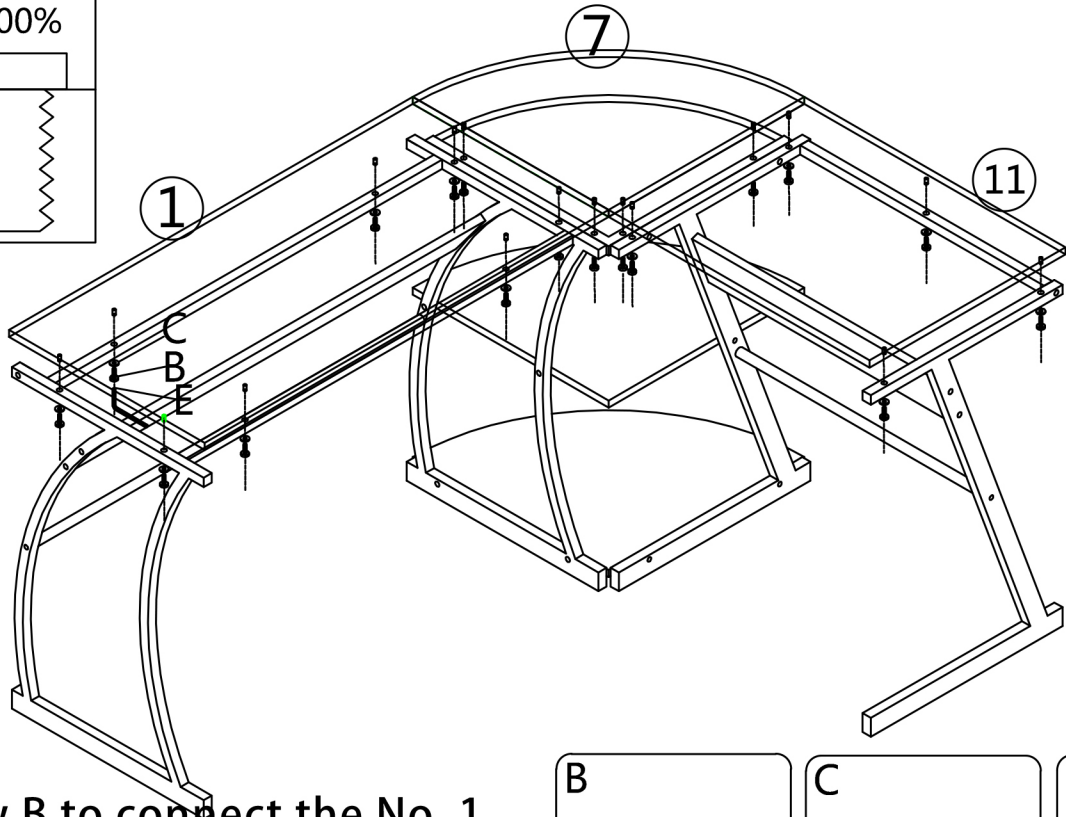
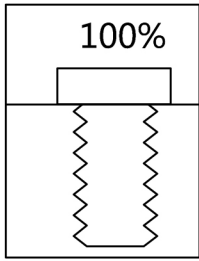

Use screw B to connect the No. 1, No. 7 and No. 11 boards to the iron frame, and tighten the screws to 100%

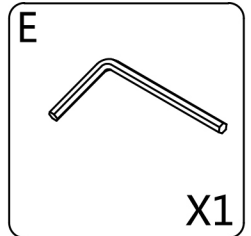
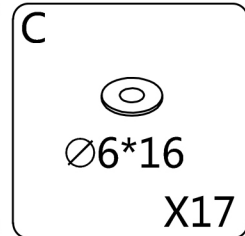
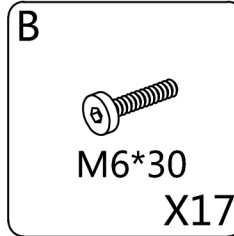

8

Note: The extra holes are for iron leg interchange

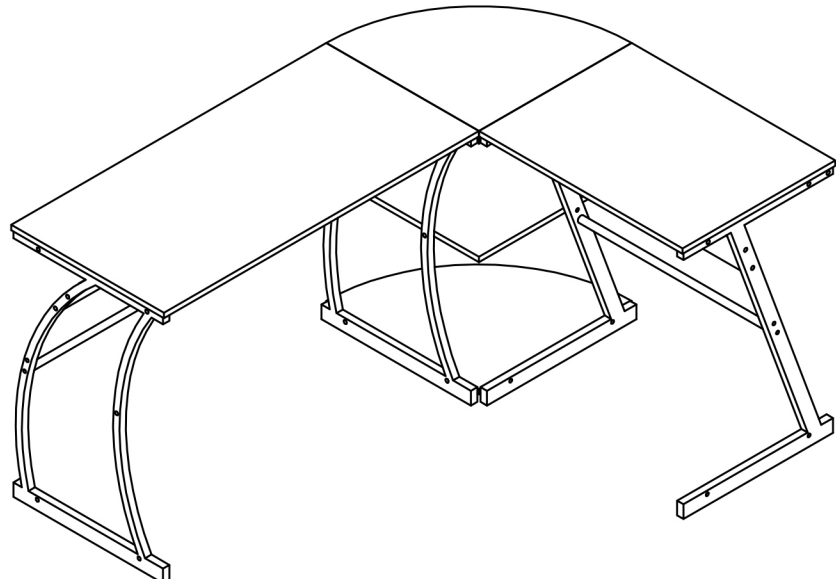

Note: please fasten all of the screws at last

OK