

# INSTRUCTION SHEET

## ASSEMBLY INSTRUCTIONS

## Madden Sideboard

Thank you for purchasing this quality product. Be sure to check all packing material carefully for small parts that may have come loose inside the carton during shipping.



**Caution:** (1) These parts are cumbersome and heavy. This product can best be assembled with the assistance of one or more persons in order to prevent personal injury and to insure parts are not damaged during the assembly process. If dirty, clean finished parts with mild dishwashing liquid and water solution applied on a damp cloth. The cloth should not be excessively wet. Polish finish with a soft cloth and an industry recognized furniture polish.

(2) To prevent damage to your floor or carpet, please check the bottom of each piece of furniture for stain residue and rough surfaces and also check for staples or nails left after removing the packaging material. The manufacturer will not be held responsible if preventative steps are not taken prior to installation.



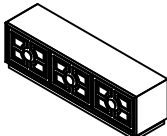

(3) Unpack and dispose of all packing material but be careful not to throw away any assembly parts or hardware. Read the instruction sheet and parts list carefully. Remove all staples and screws used for packaging carefully using pliers and (or) screwdrivers to prevent injury and scratching or damaging flooring.

(4) During normal use everyday, screws, bolts, nuts and wooden plugs may loosen up. They should be periodically inspected and re-tightened to prevent damage to the furniture and (or) personal property or cause injury. Always check to be sure all hardware on this list and the above mentioned components is attached to the furniture properly and kept tightened at all times.

### Parts List:

Description	Sketch	QTY
Sideboard (A)		1 pc
Leg (B)		4 pcs

### Hardware List:

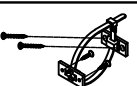
1	Hex Head bolt	5/16"x2"		8 pcs
2	Spring washer	5/16"		8 pcs
3	Flat washer	5/16"x19mm		8 pcs
4	Wrench	12mm		1 pc
5	Anti-tip Kit			1 set

**Assembly Procedure:** (Please follow the sketches below.)

**Step 1:** Unpack, inspect, and read assembly instruction carefully. Lay out the parts and hardware. Make sure the quantity of each is correct.

**Step 2:** Assemble the Legs (B) to the bottom of Sideboard (A) using Hex Head bolt (1), Spring washer (2), Flat washer (3). Tighten all bolts securely with Wrench (4), but do not over tighten the bolts.

**Step 3:** Install Anti-tip Kit (5) as directed by the instructions in the tip-restraint bag. Use adjustable leveler as necessary.

**Assembly is now complete.**

# INSTRUCTION SHEET

ASSEMBLY INSTRUCTIONS

Madden Sideboard

STEP 2

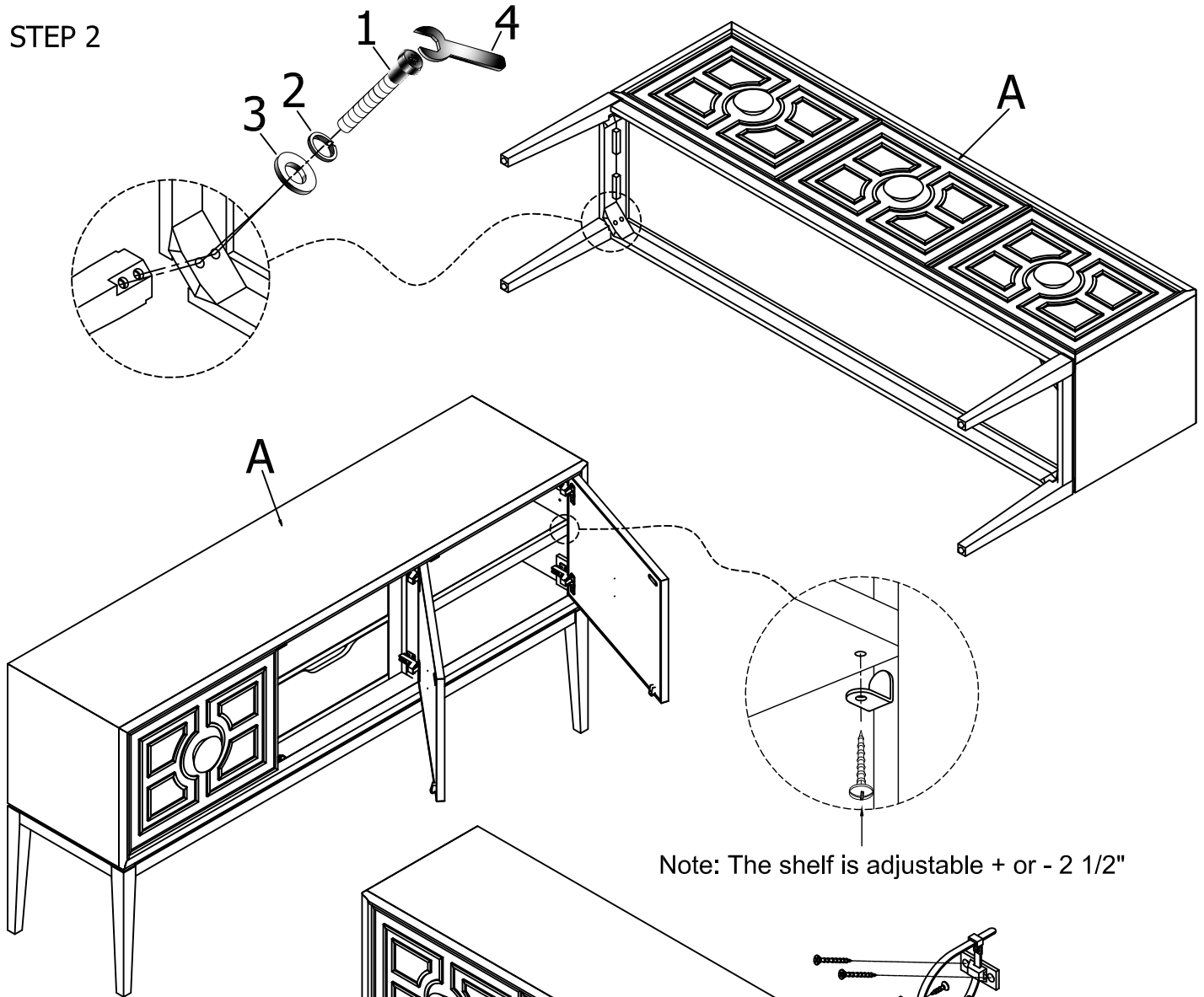

Note: The shelf is adjustable + or - 2 1/2"

Adjustable  
Leveler

STEP 3

