

Owner Manual

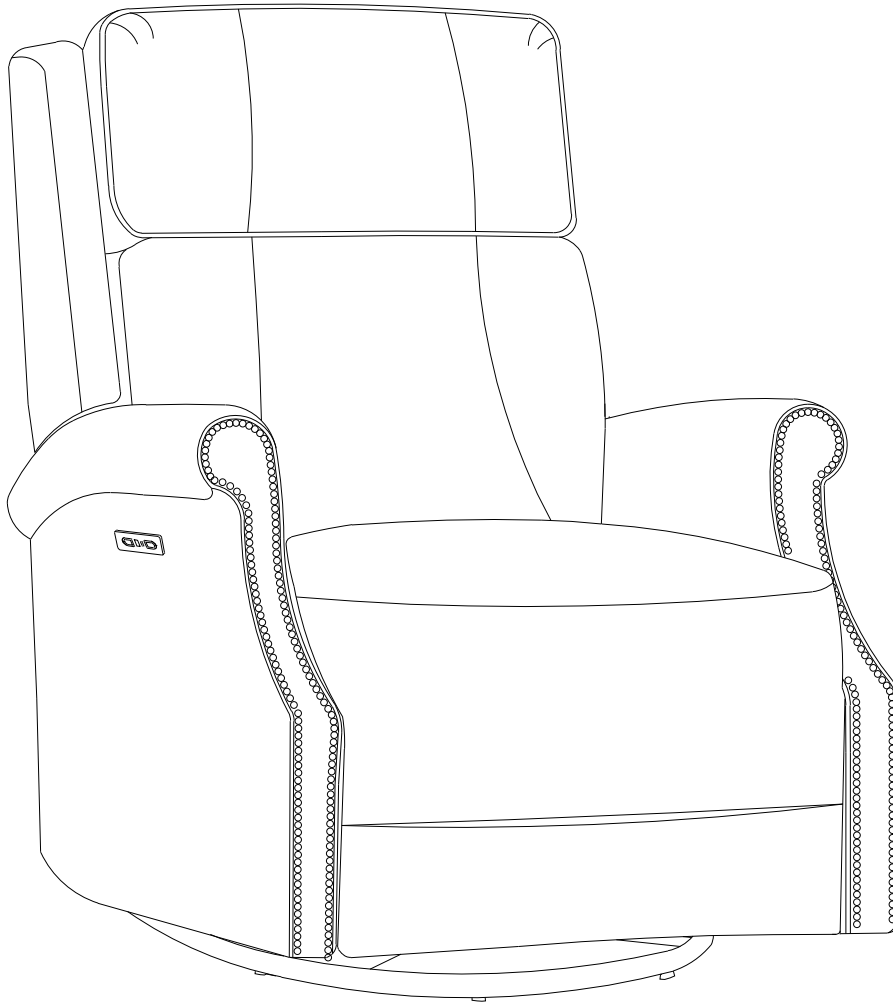

Thank you for purchasing the Genuine Leather Swivel Rocker Power Recliner.

Please read the instructions and warnings carefully before use, to ensure safe and satisfactory operation of this product. We are committed to making great products possible. From our in-house Design Team, to our Buyers, we work together to bring great designs to life. Our expert Product Technologists work collaboratively with our buyers and suppliers to assure the legality, safety and quality of the product we sell. We are all committed to designing and developing products to the highest industry standards. We hope you are happy with your product and welcome any feedback or comments you may have.

PARTS LIST

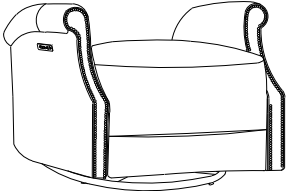
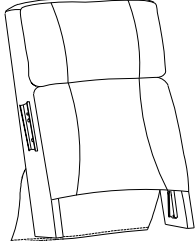
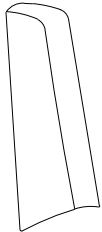
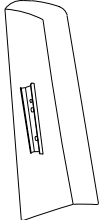
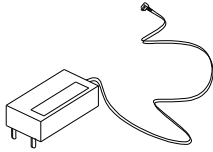
<p>A  x 1</p> <p>Seat Frame</p>	<p>B  x 1</p> <p>Back</p>	<p>C  x 1</p> <p>Left Wing</p>
<p>D  x 1</p> <p>Right Wing</p>	<p>E  x 1</p> <p>Power Adapter (2.5M)</p>	

Be sure to check all packing material carefully for small parts, which may have come loose inside the carton during shipment.

STEP 1

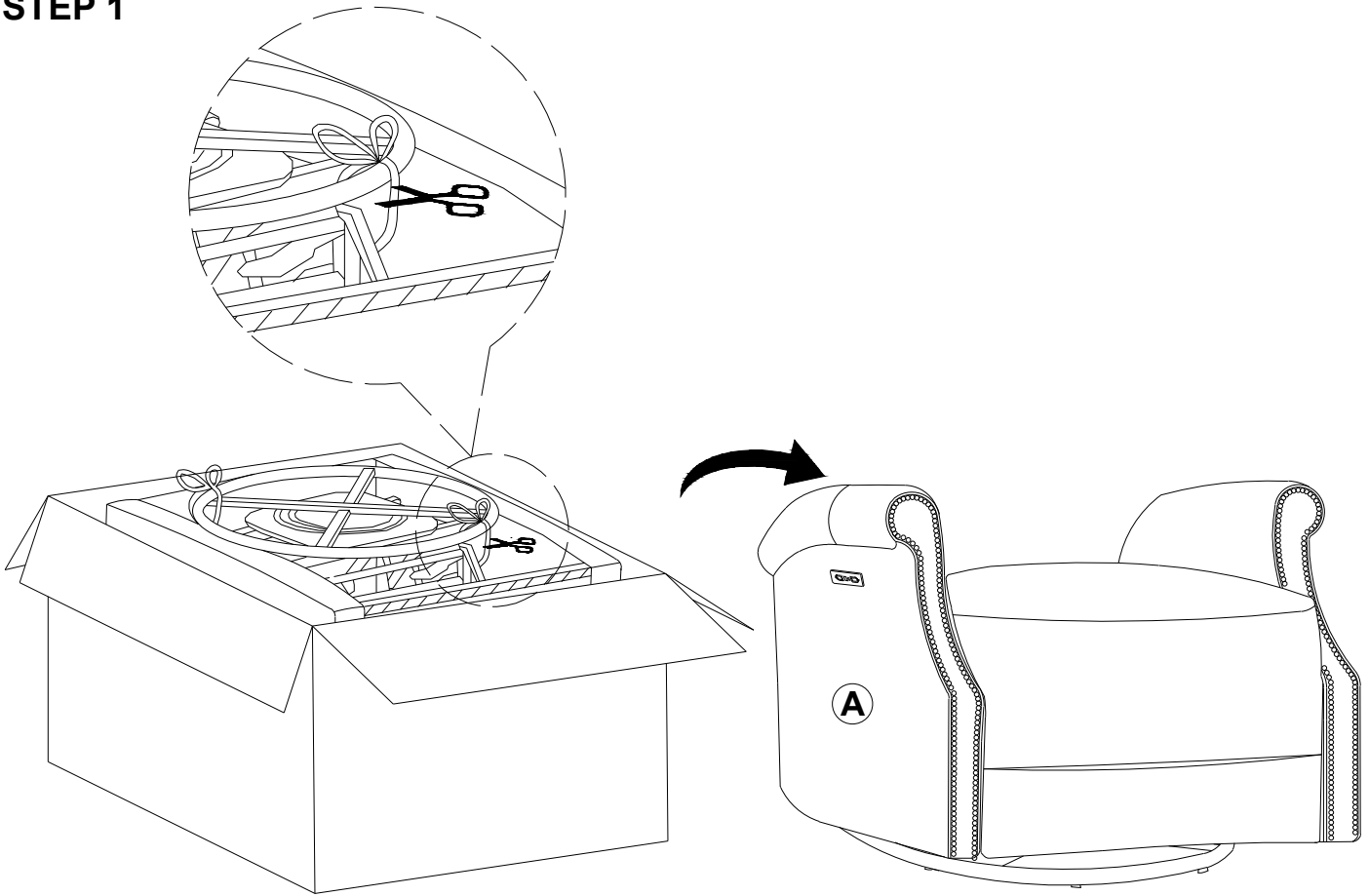

STEP 2

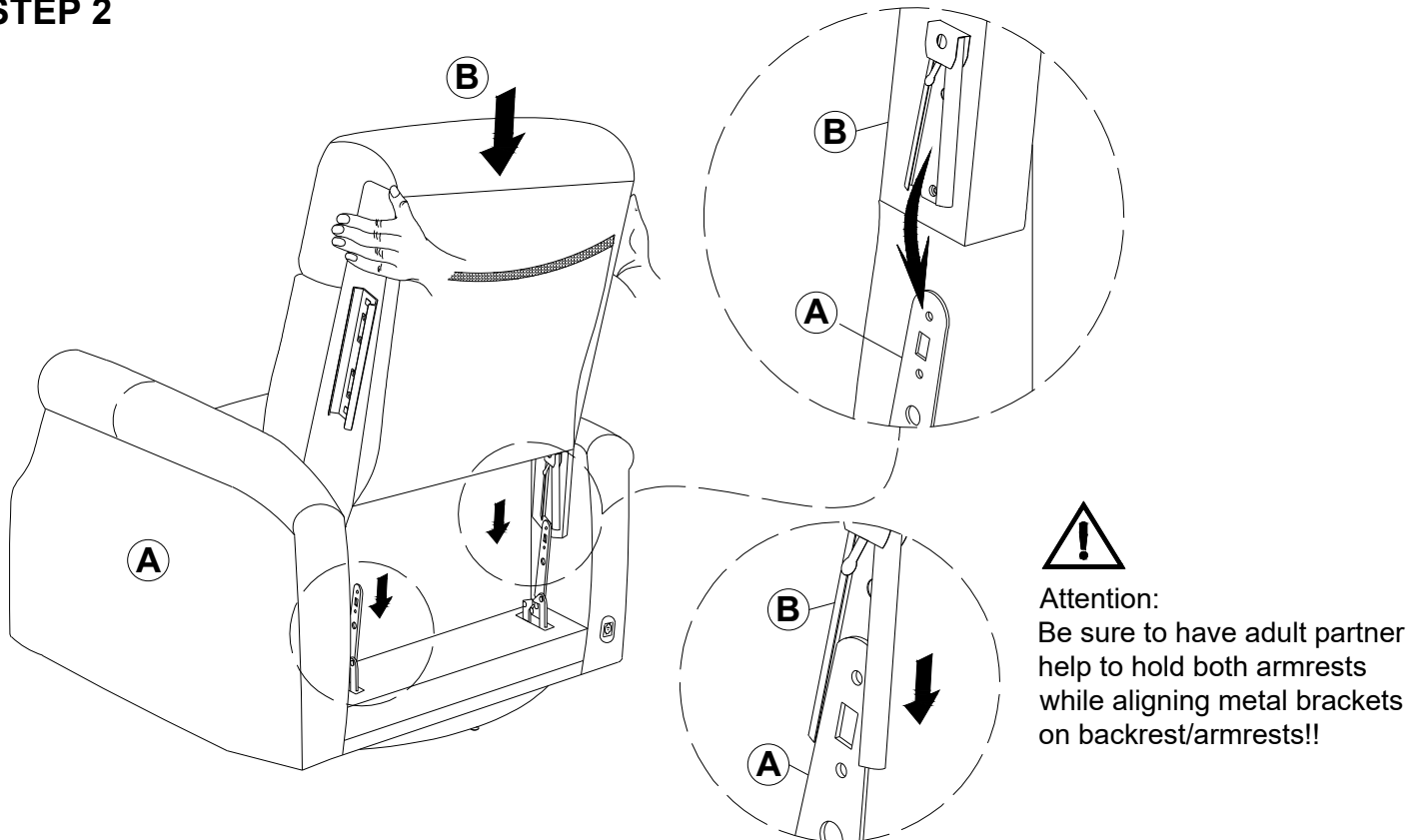

Attach the Back (B) to the Seat Frame (A) by sliding the receivers into the mechanism posts located on the Seat Frame (A).

STEP 3

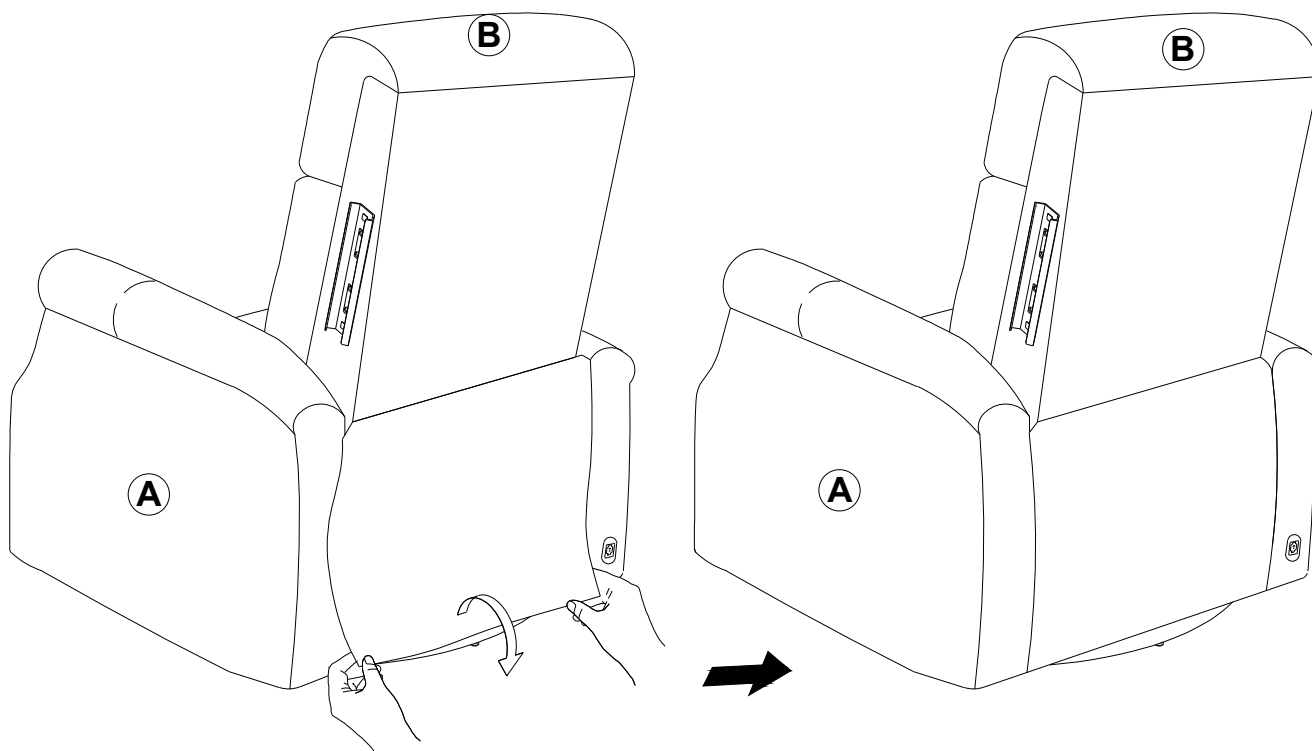

STEP 4

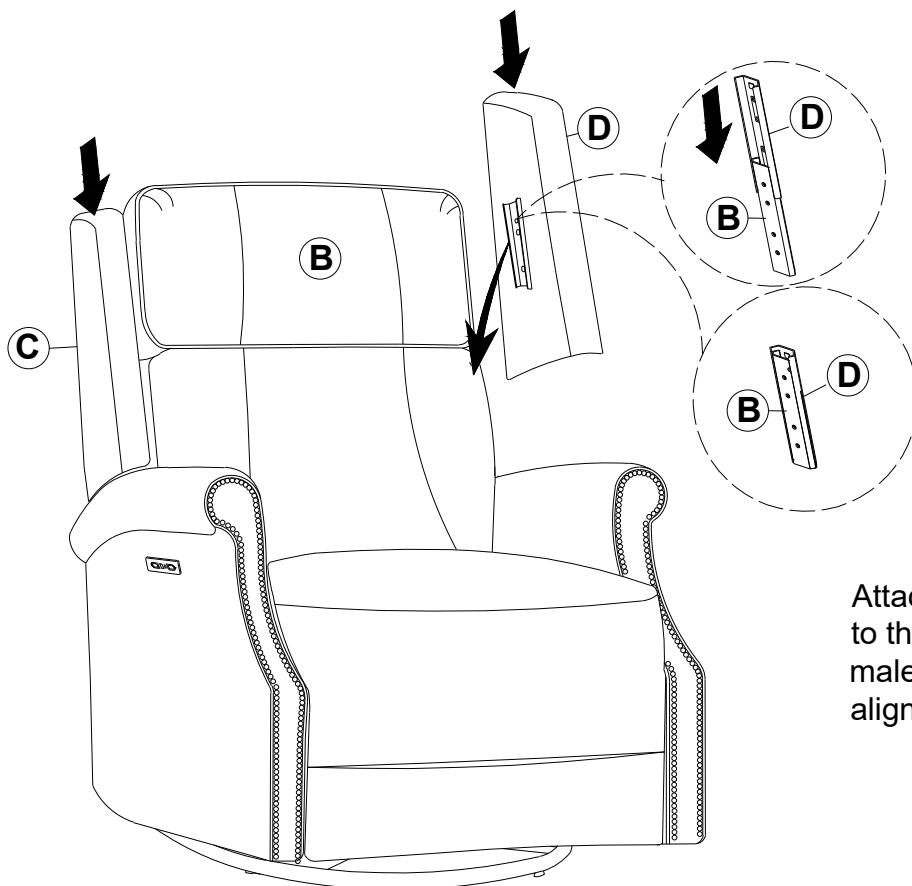

Attach the back wing (C) (D) to the back. Make sure the male and female brackets align as shown.

STEP 5

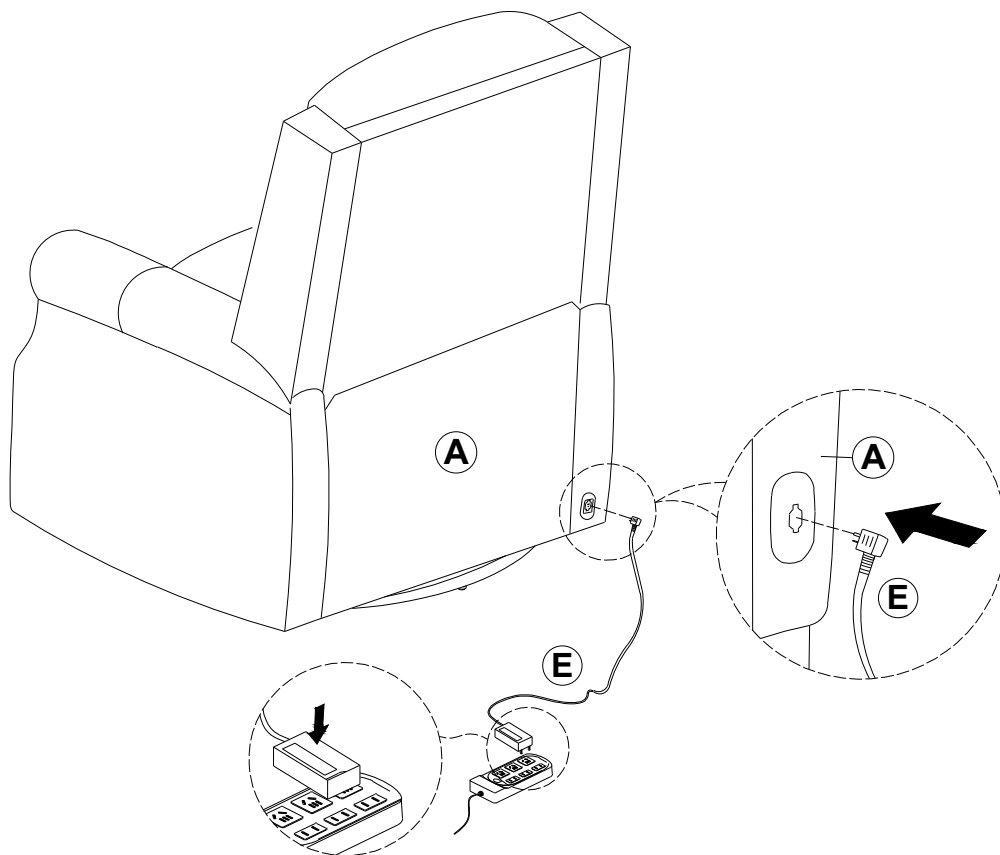

STEP 6

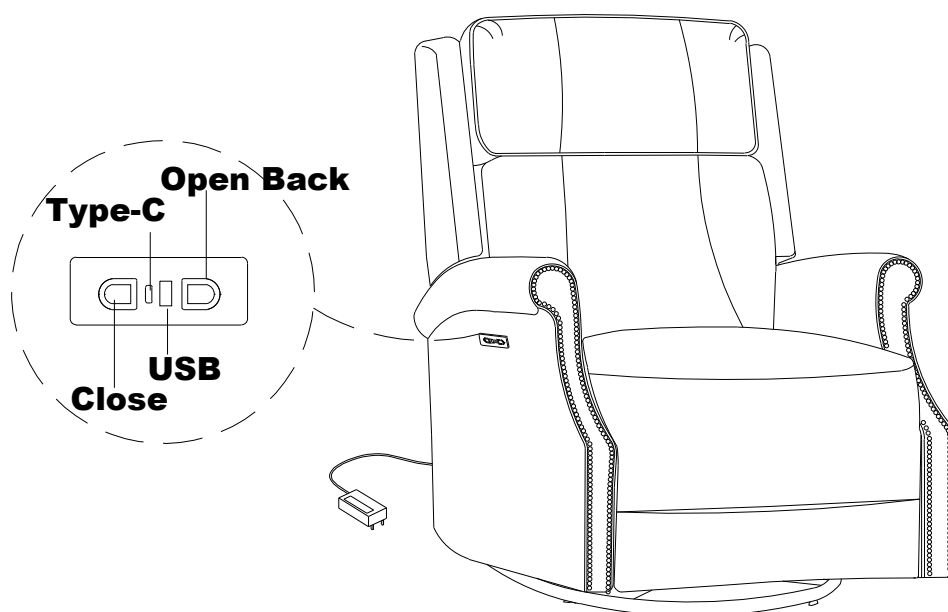

STEP 7

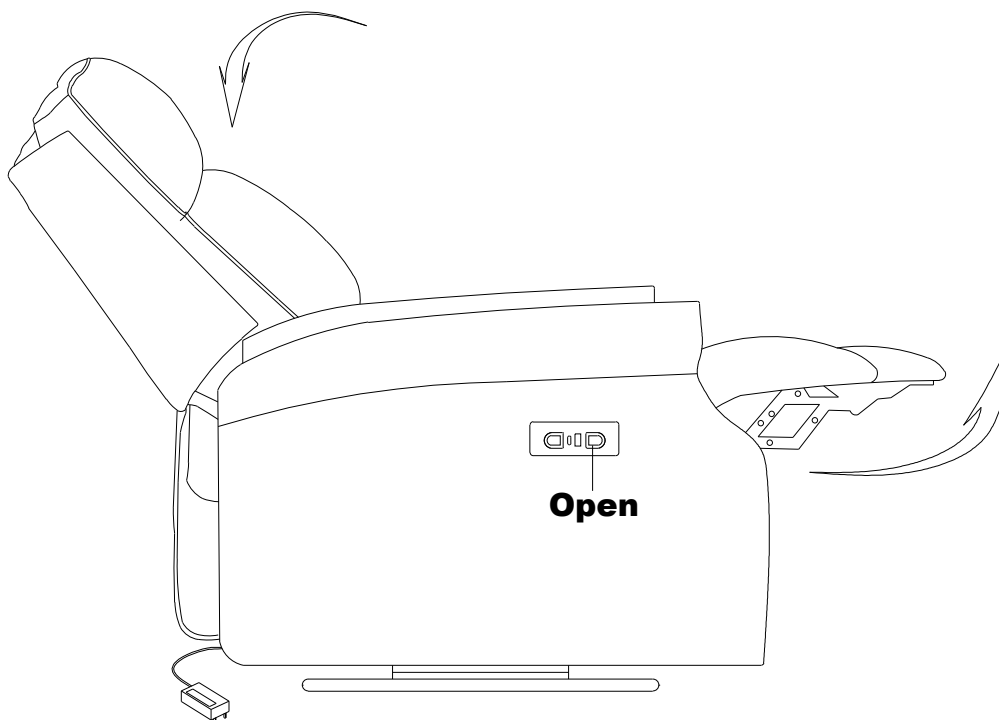

STEP 8

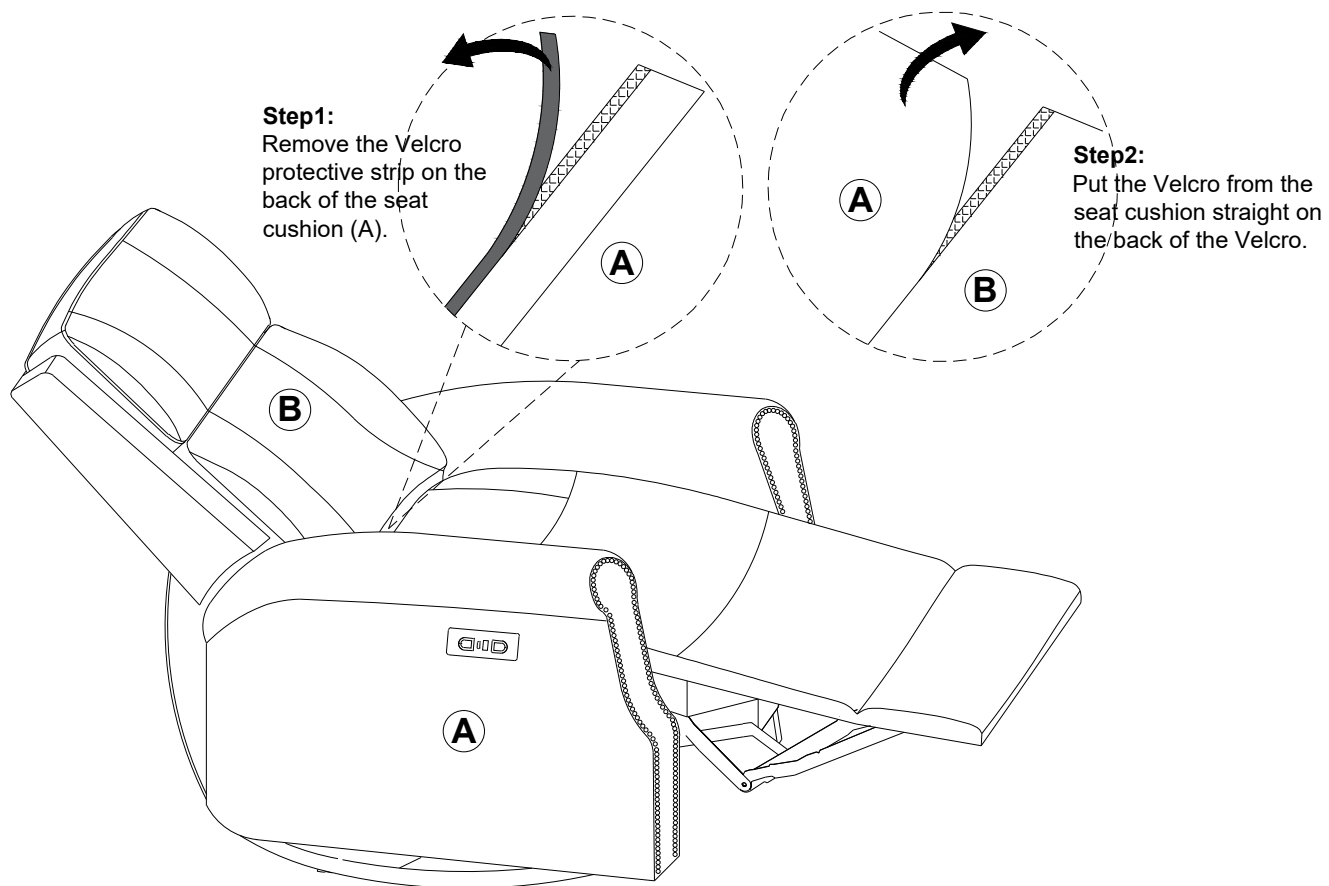

STEP 9

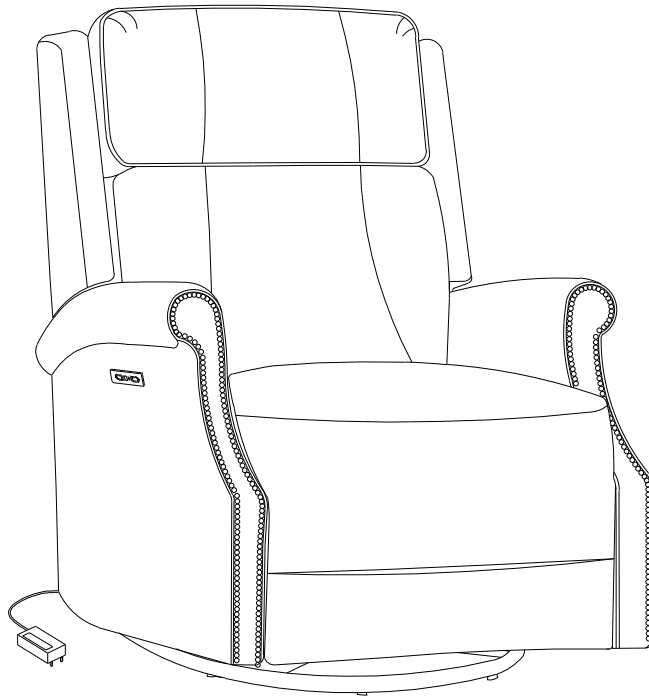

STEP 10

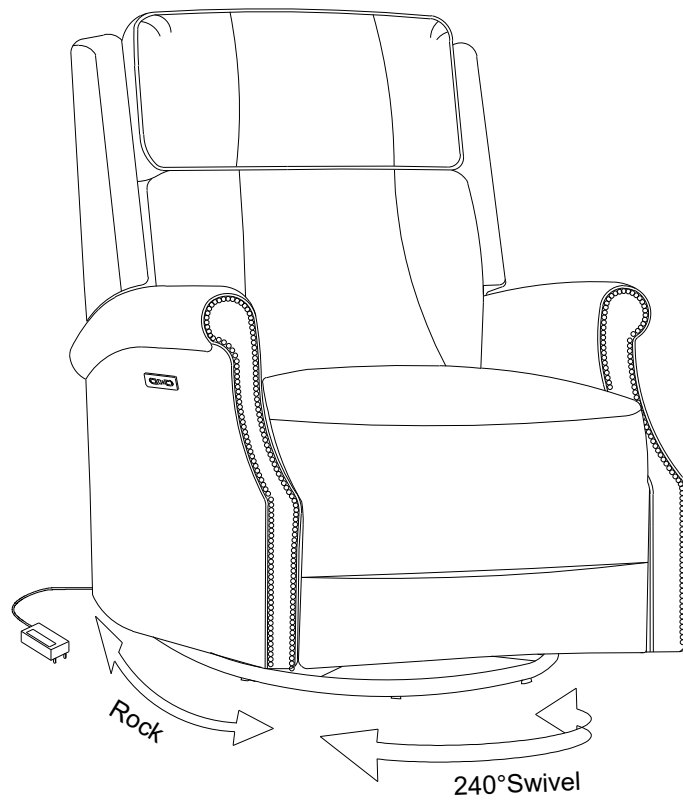

MAINTENANCE AND WARNING

- Keep furniture away from heat.
- Do not clean furniture with harsh cleansers or polish. Do not use detergents, Solvents, abrasives, spray packs or leather cleaner. Use non-color mild soap with warm water clean spills(Mix 1:10 soap to water)
- Do not place furniture under direct sunlight, material will possibly fade over time.
- Do not use on site dry Cleaning machine.
- Children should not climb or jump on the furniture.
- Do not write on furniture without a padded barrier to protect the surface.
- Not for commercial use, For residential use only.
- The maximum load is 330 LBS.

WARRANTY

We strive to offer high , quality products, and we also try our best to satisfy each and every customer that orders from us with product or service as needed. We provide 30 days warranty starting from the time you receive the item. Each customer must provide a record of their order such as the order number, or item receipt for any items that are out of the warranty period you may also still receive replacement parts by purchasing them with our company if they are available.

Are you having difficulty with assembly? Missing parts? Please send email with your order No to customerservice@hulalahome.com

For return, please check the return policy with the retailer or market place you bought from. Appreciate your purchasing from us. Pop up your life by our furniture piece!