

INSTRUCTION MANUAL

8.2X6.2X6.7FT
GREEN HOUSE

ATTENTION

1. Please secure your greenhouse in windy conditions with extra ropes when wind speed exceeds 24 miles/hour.
2. Please try to install your greenhouse away from direct wind conditions.
3. Please keep your greenhouse clear of snow during snowy conditions. Snow coverage can not be over 2 inches high.
4. We will not take any responsibility of greenhouse damaged by severe weather.

HARDWARE

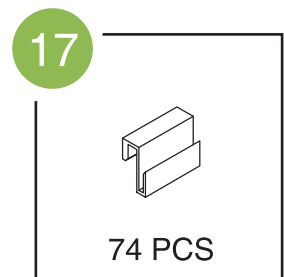
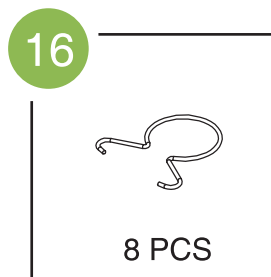
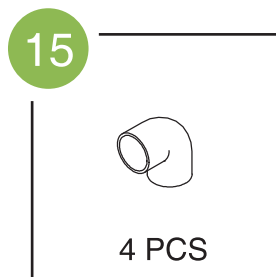
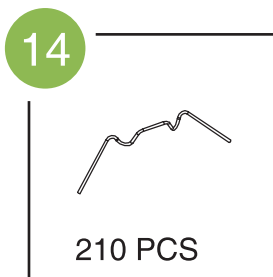
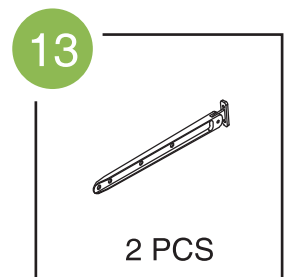
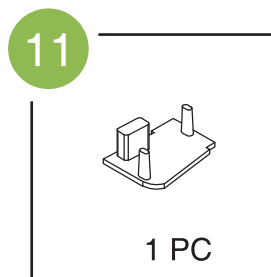
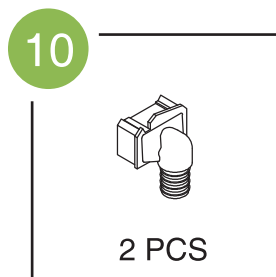
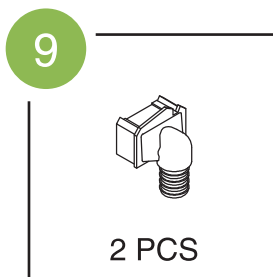
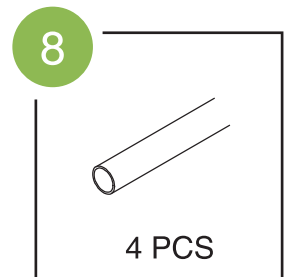
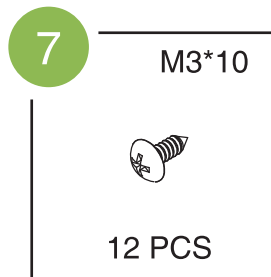
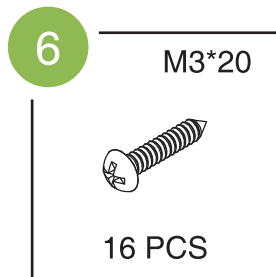
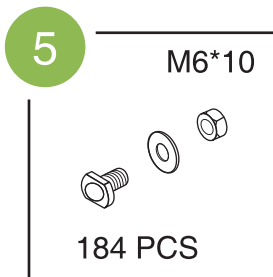
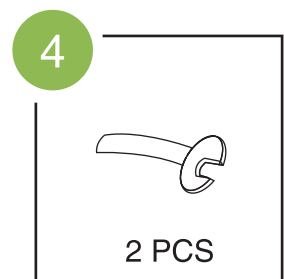
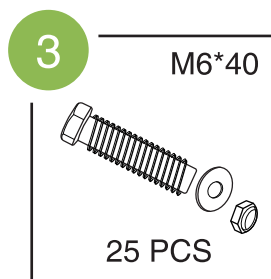
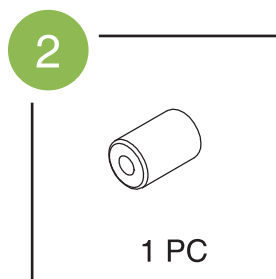

HARDWARE

18

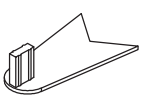

2 PCS

19

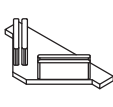

4 PCS

20

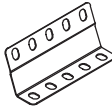

2 PCS

21

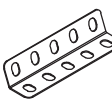

1 PCS

22

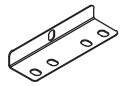

2 PCS

23

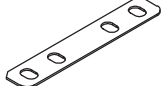

2 PCS

24

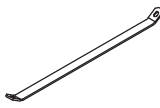

9 PCS

25



4 PCS

26

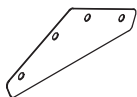

4 PCS

27-1 1830

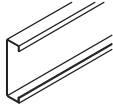

2 PCS

27-2 1220

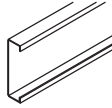

4 PCS

28



4 PCS

29

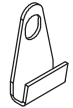

14 PCS

30

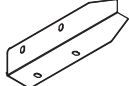

4 PCS

31

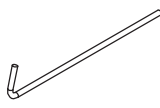

14 PCS

32

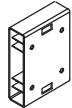

2 PCS

33



6 PCS

35



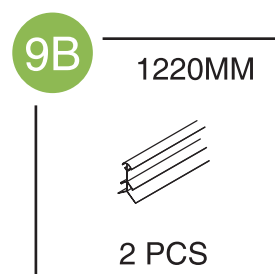
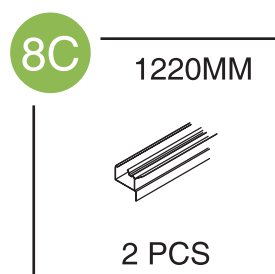
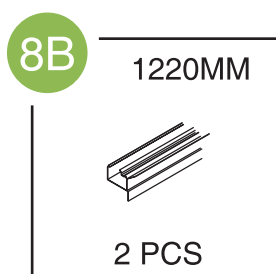
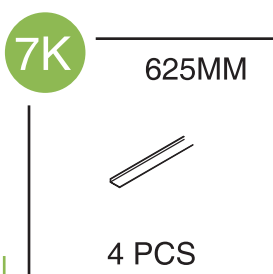
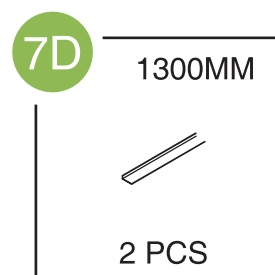
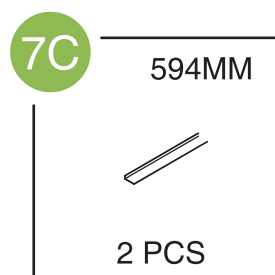
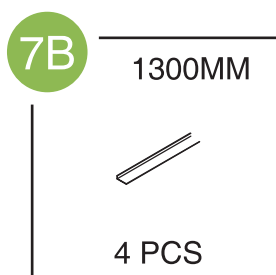
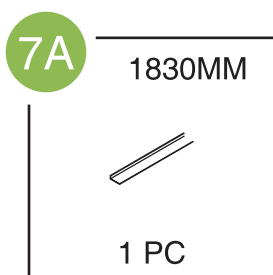
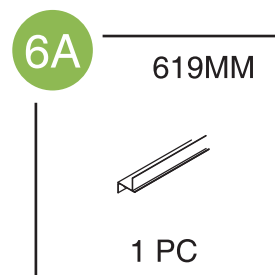
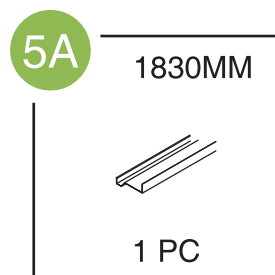
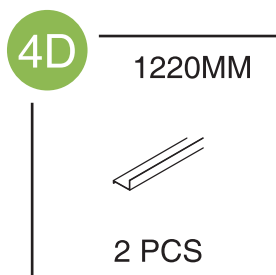
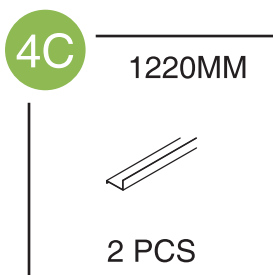
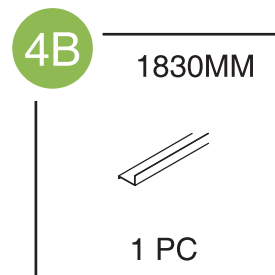
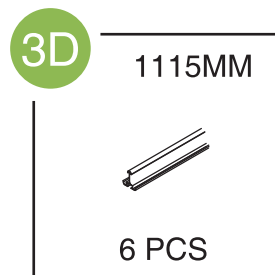
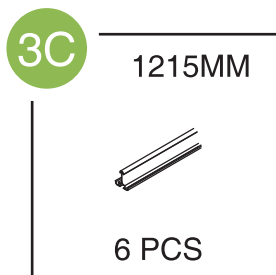
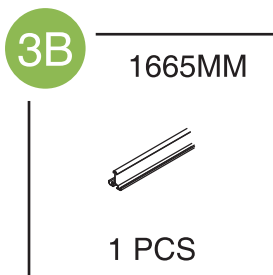
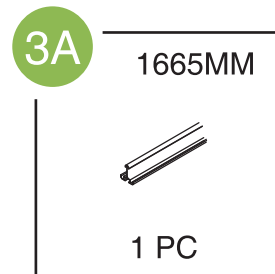
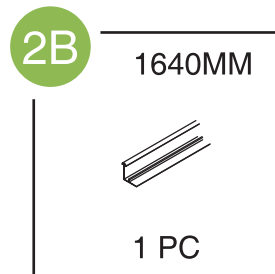
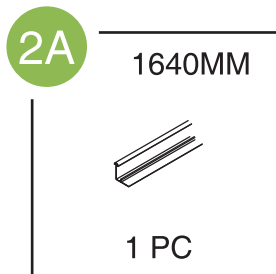
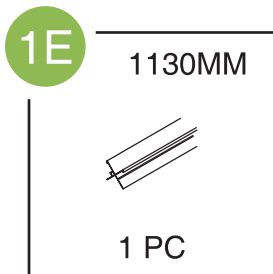
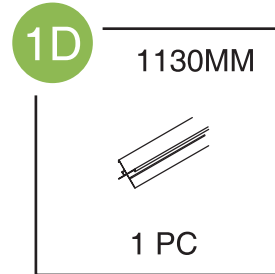
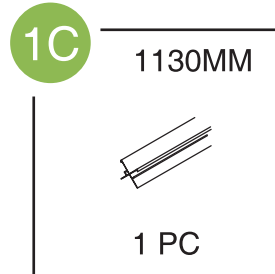
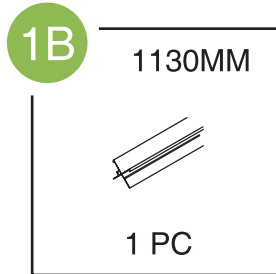
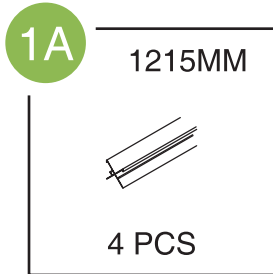

184 PCS

PARTS





PARTS

10A 635MM

 2 PCS

11A 625MM

 1 PC

12A 610MM

 1 PC

13A 1250MM

 1 PC

14A 380MM

 1 PC

15A 1600MM

 2 PCS

16A 625MM

 2 PCS

17A 625MM

 1 PC

18B 595MM

 2 PCS

19B 520MM

 4 PCS

20B 595MM

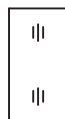
 2 PCS

21A 603MM

 5 PCS

A4 603*1210MM

 13 PCS

B4 603*1120MM

 6 PCS

D4 603*590MM

 2 PCS

E4 595*550MM

 2 PCS

F4 603*655MM

 1 PC

G4 620*240MM

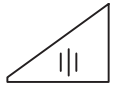
 1 PC

H4 620*230MM

 1 PC

I4 620*600MM

 2 PCS

X4 603*440MM

 4 PCS

PRODUCT ASSEMBLY

The ground must be firm and level. The greenhouse will only become permanent and stable if it is precisely aligned vertically and horizontally with a spirit level. Even with slightly sloping walls, these can no longer be properly inserted as the guides provided and can easily be removed by the wind. The greenhouse must definitely be anchored in the ground. The large surface of the Greenhouse offers a large surface area for wind, which can cause considerable injuries and / or property damage.

1 Installation of the foundation

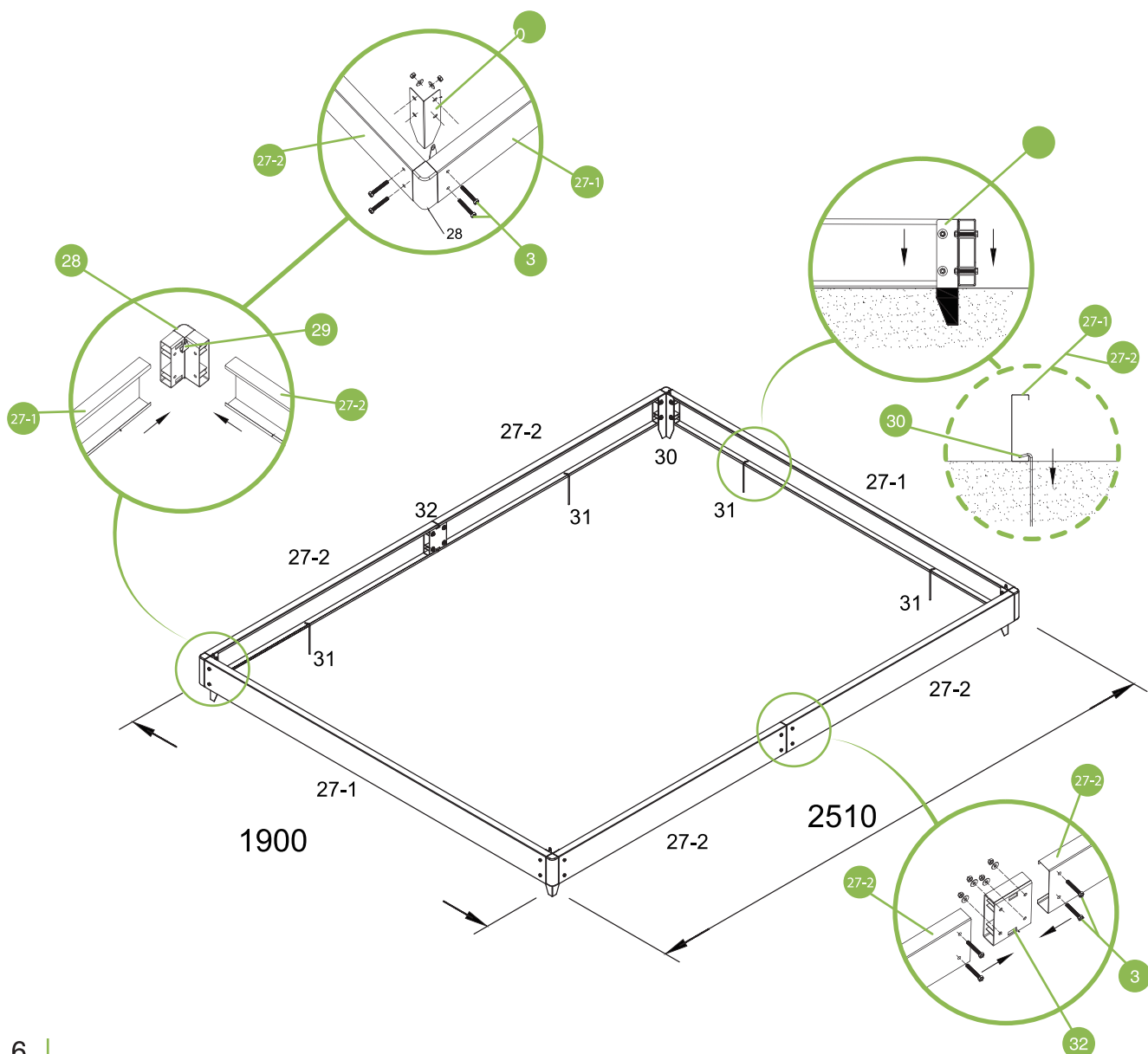
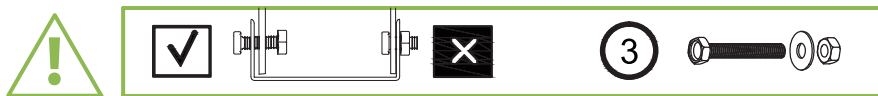
Before building the greenhouse, it is essential to have a suitable foundation prepared accordingly (included in delivery).



PRODUCT ASSEMBLY

2

Assembly of the roof windows

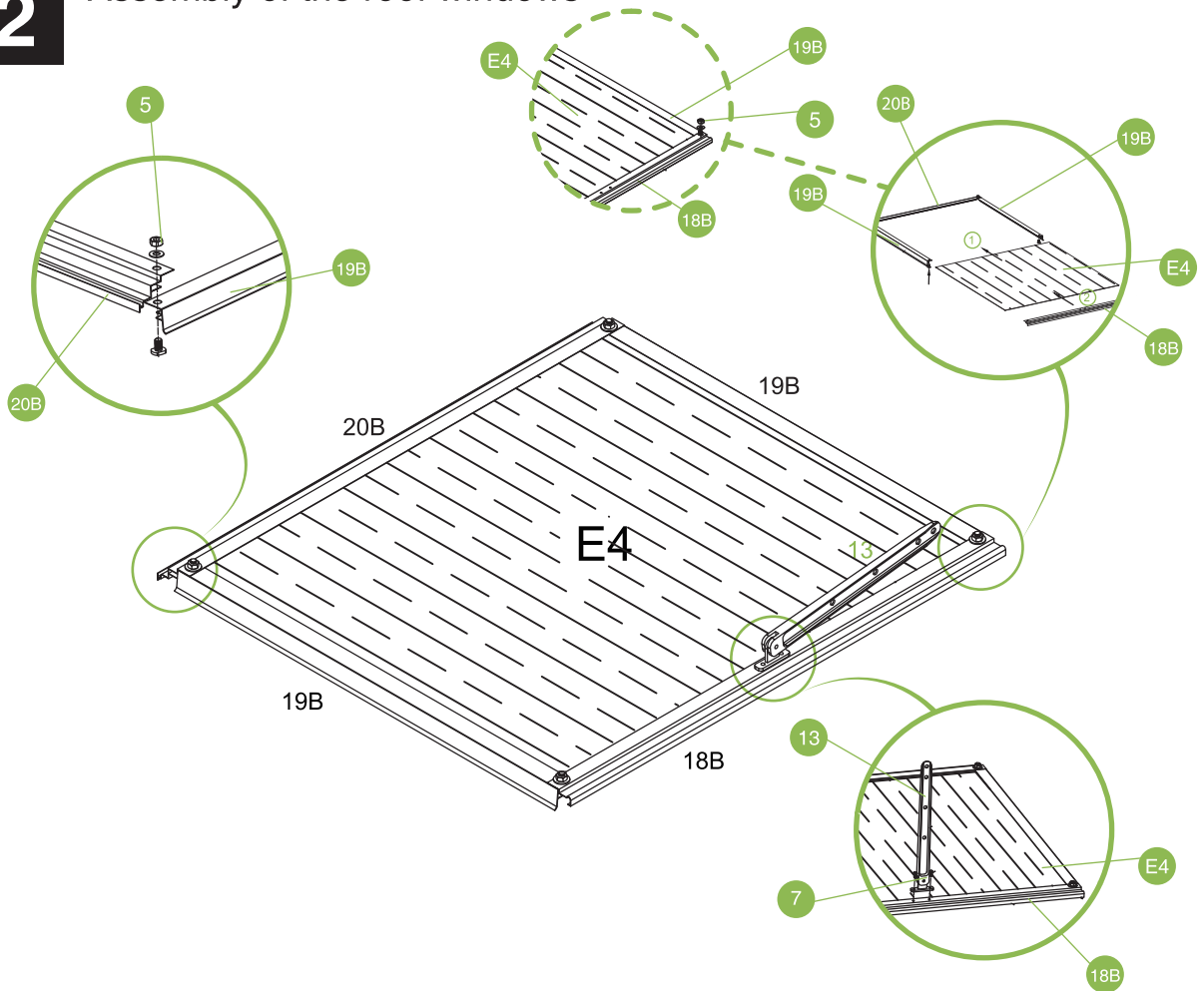

3

Assembly of the door

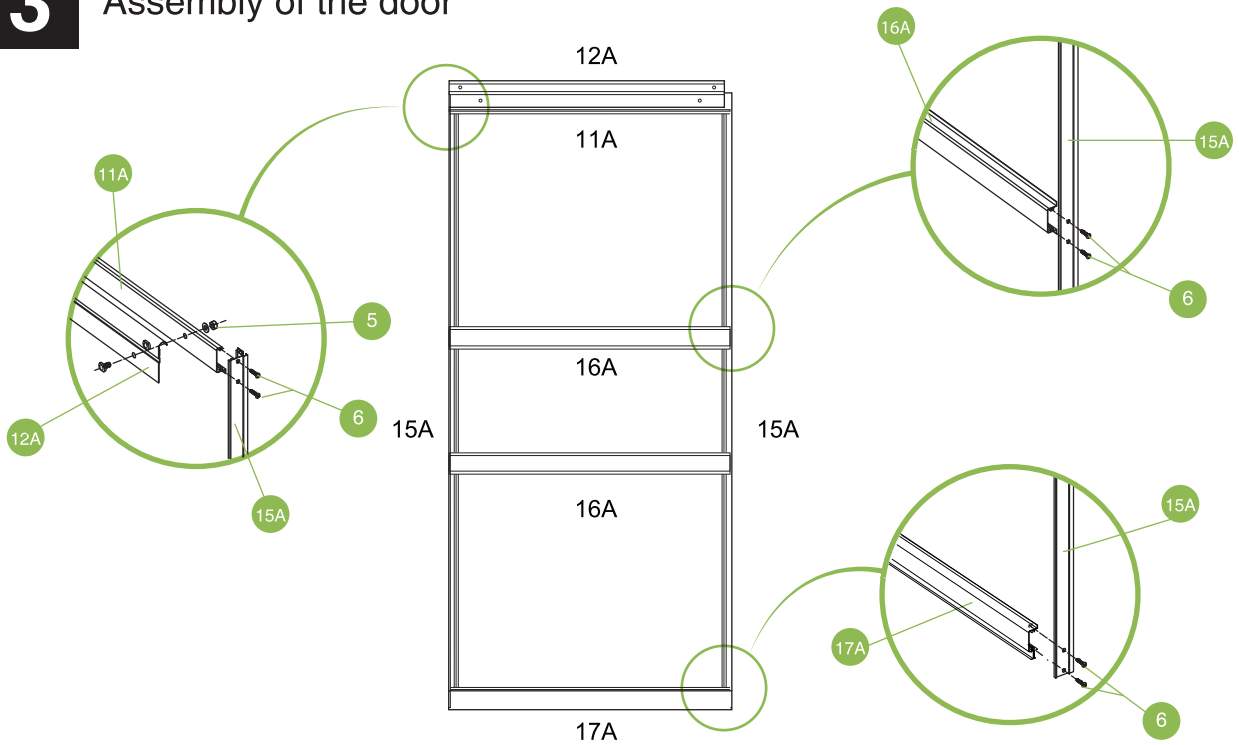

4

Assembly of the front wall

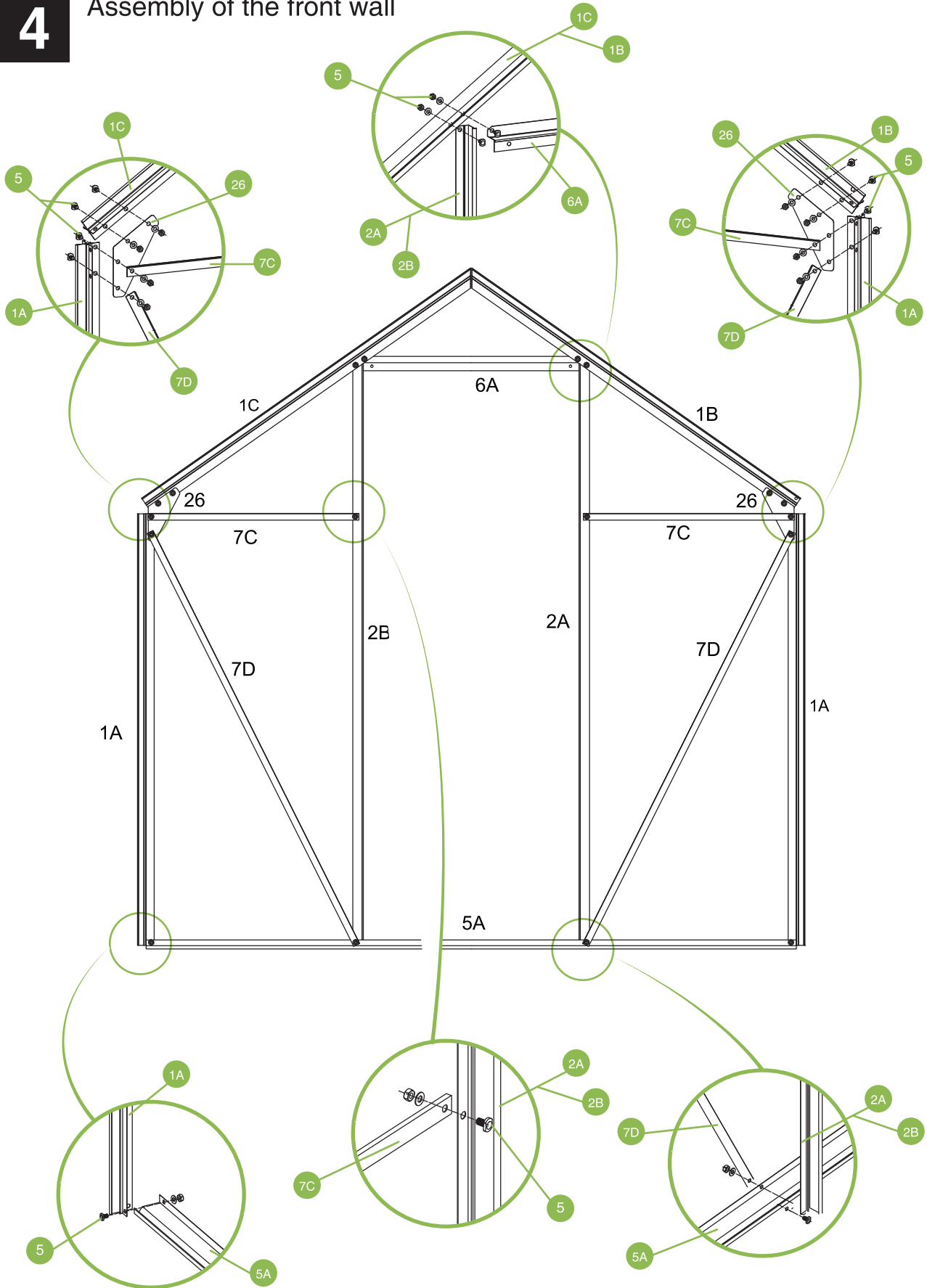

PRODUCT ASSEMBLY

5

Attaching the door

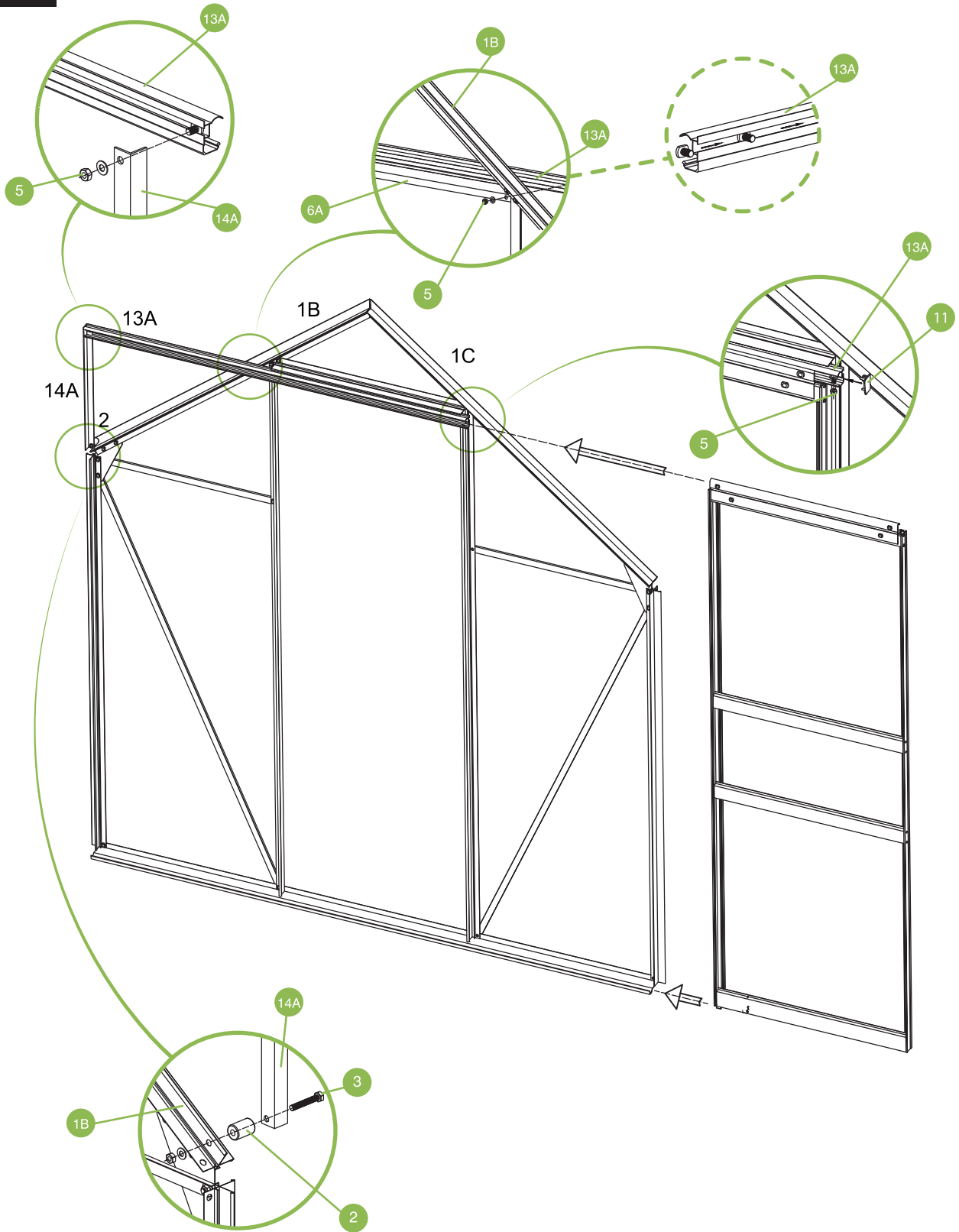

6

Assembly of the side walls

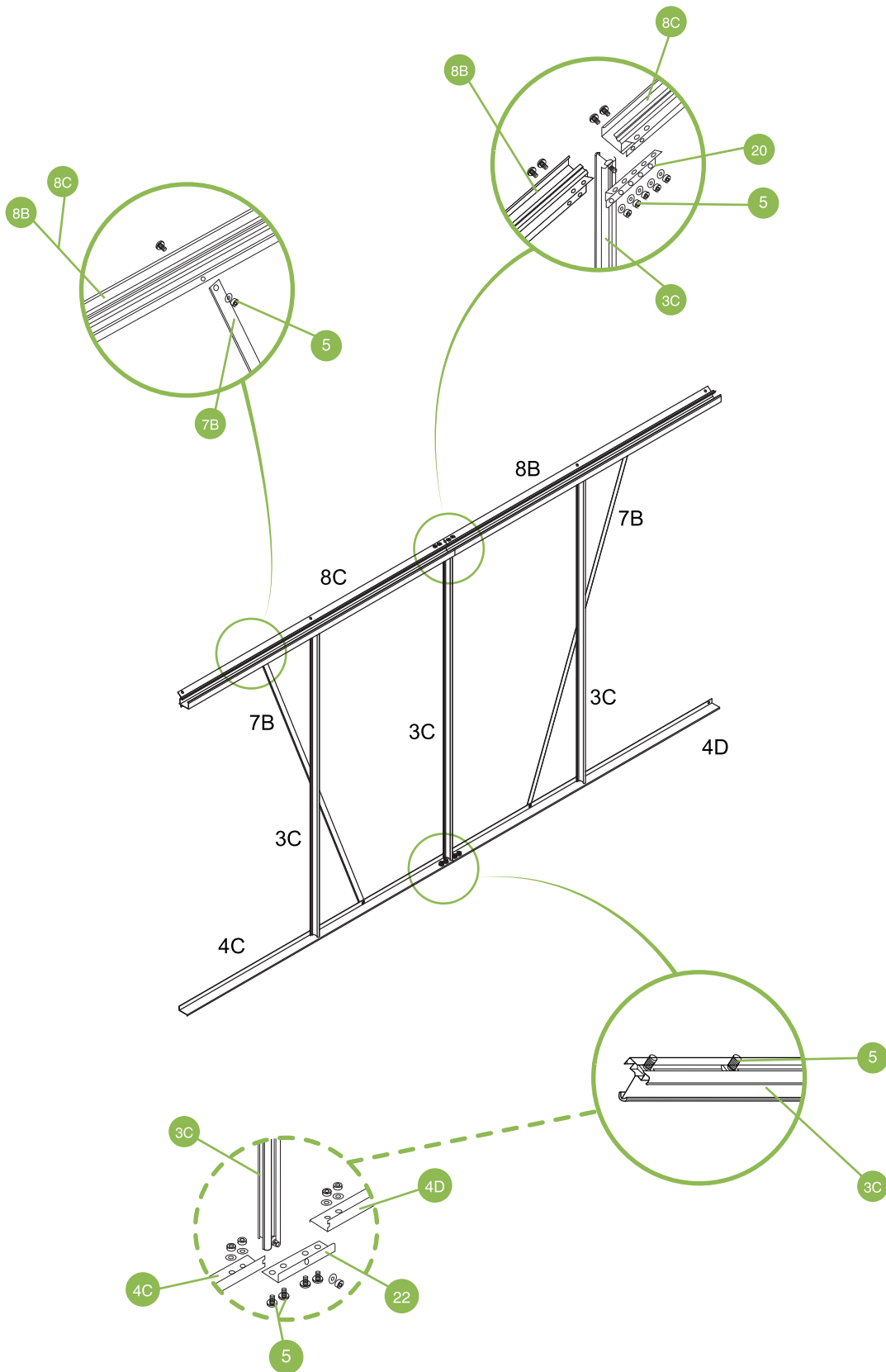

6

Assembly of the side walls

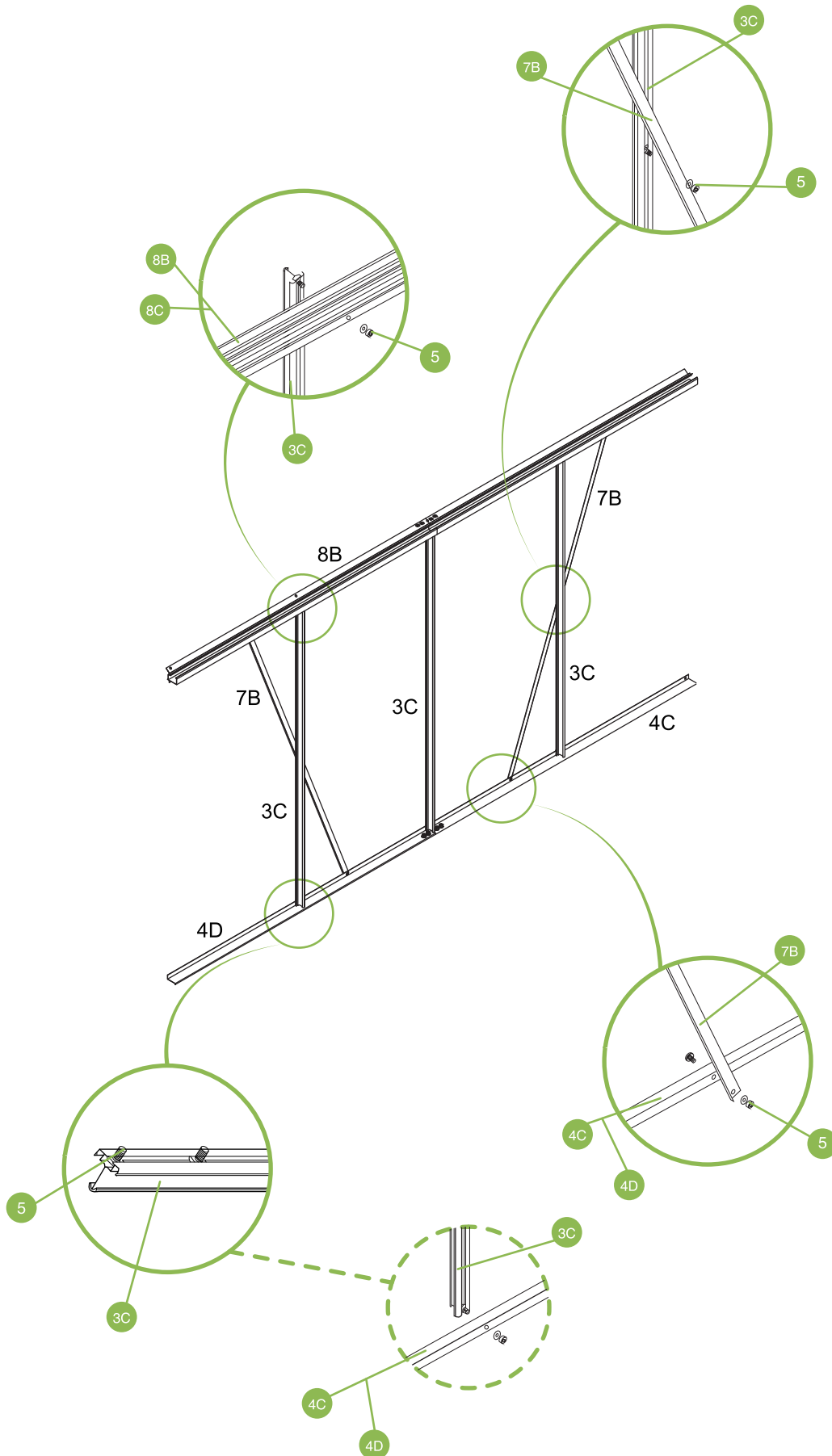

7

Assembly of the back wall

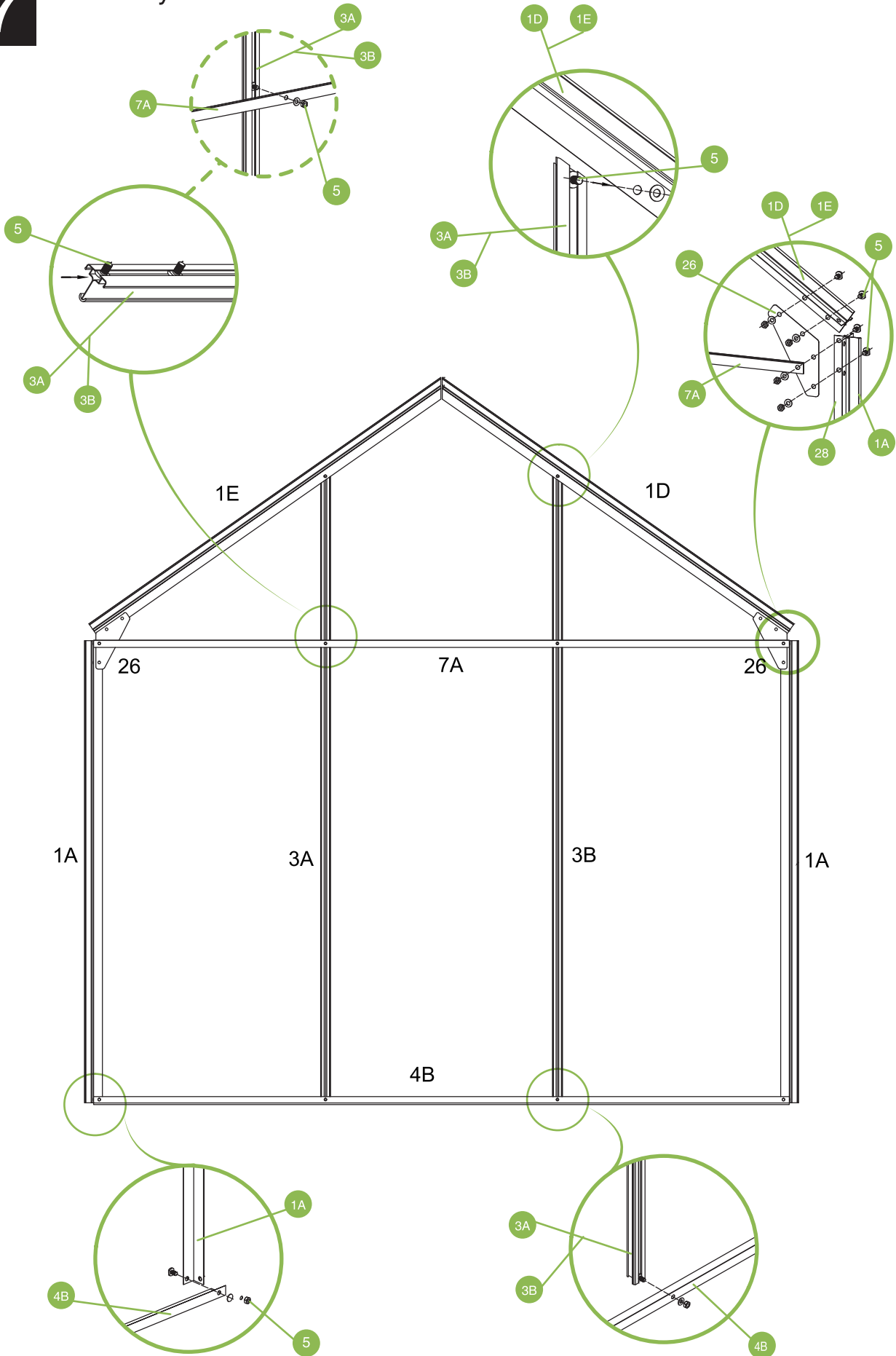

8

Assembly of the scaffolding

In order to assemble the 23 mounting plates in the right image 8.2, holes 9B in the 2-roofing cable profile must have been drilled with a battery screwdriver or a drilling machine. Please attach the 23 mounting plates to the position to be mounted on the 2x9B roof tile and mark the hole positions on the profiles. Then drill the 6mm holes. Attach the 23 mounting plates to the 2x9B roof panel with screws & nuts 5.

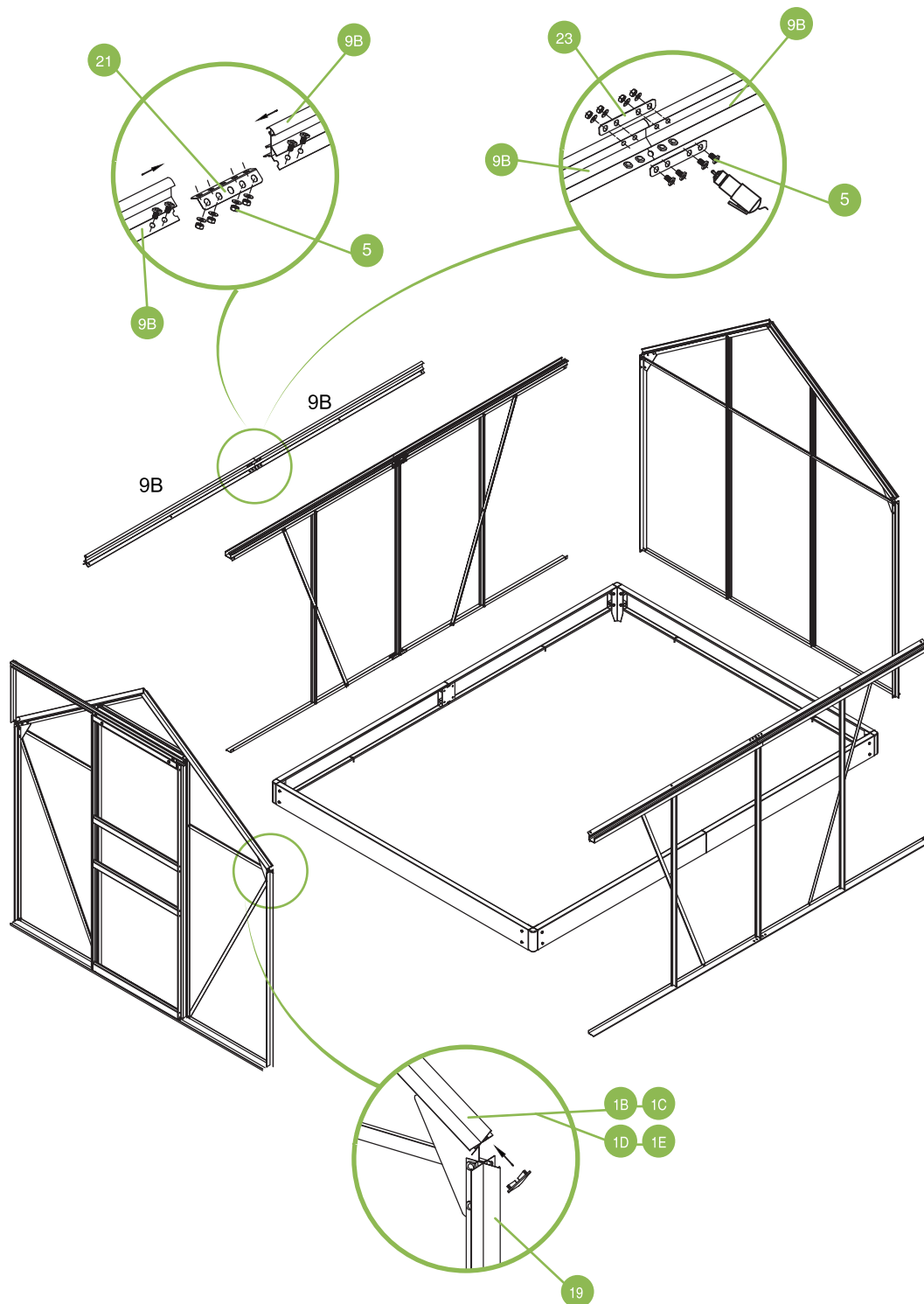

9

Assembly of the scaffolding

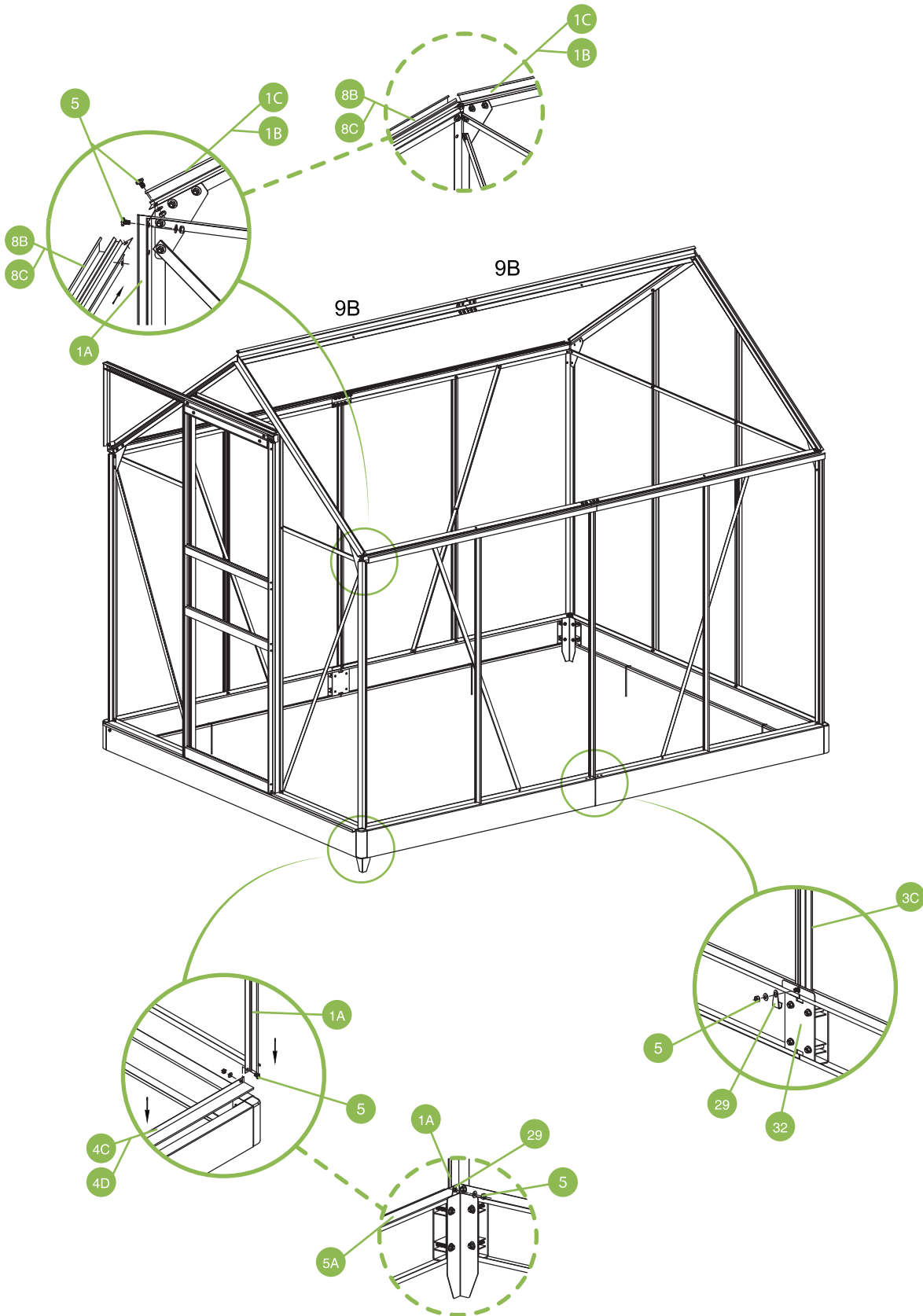

9

Assembly of the scaffolding

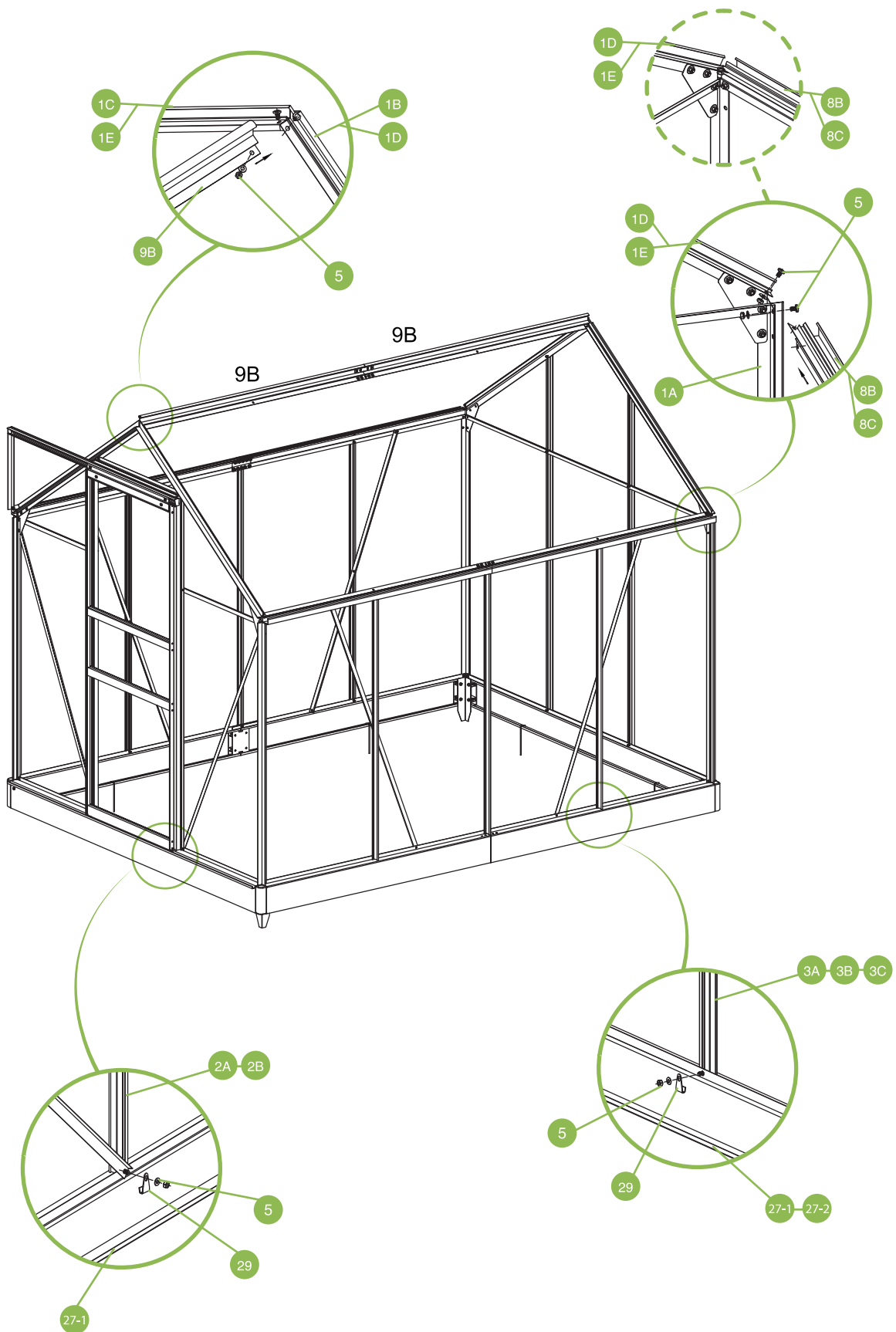

10 Roof profile assembly

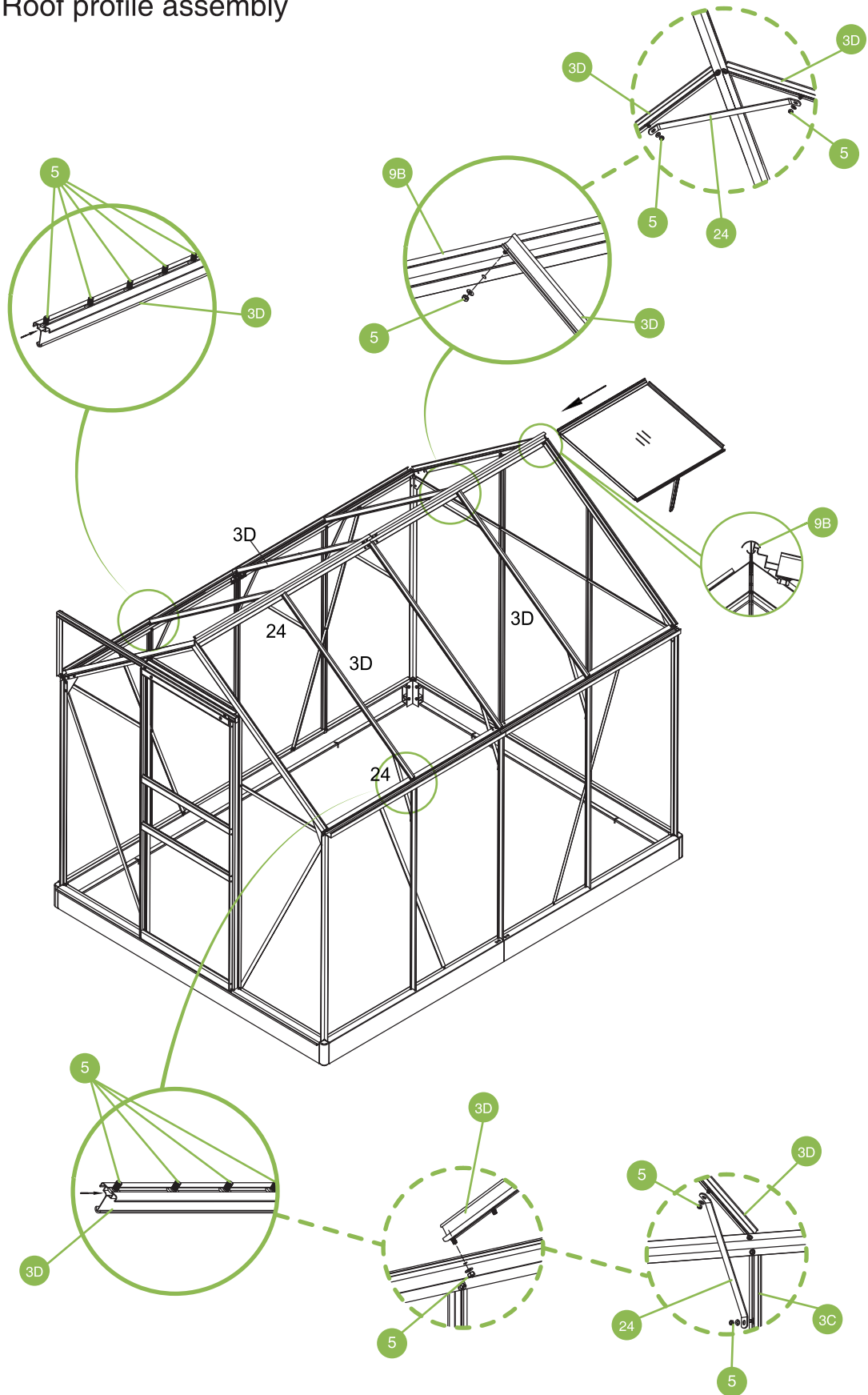

10 Roof profile assembly

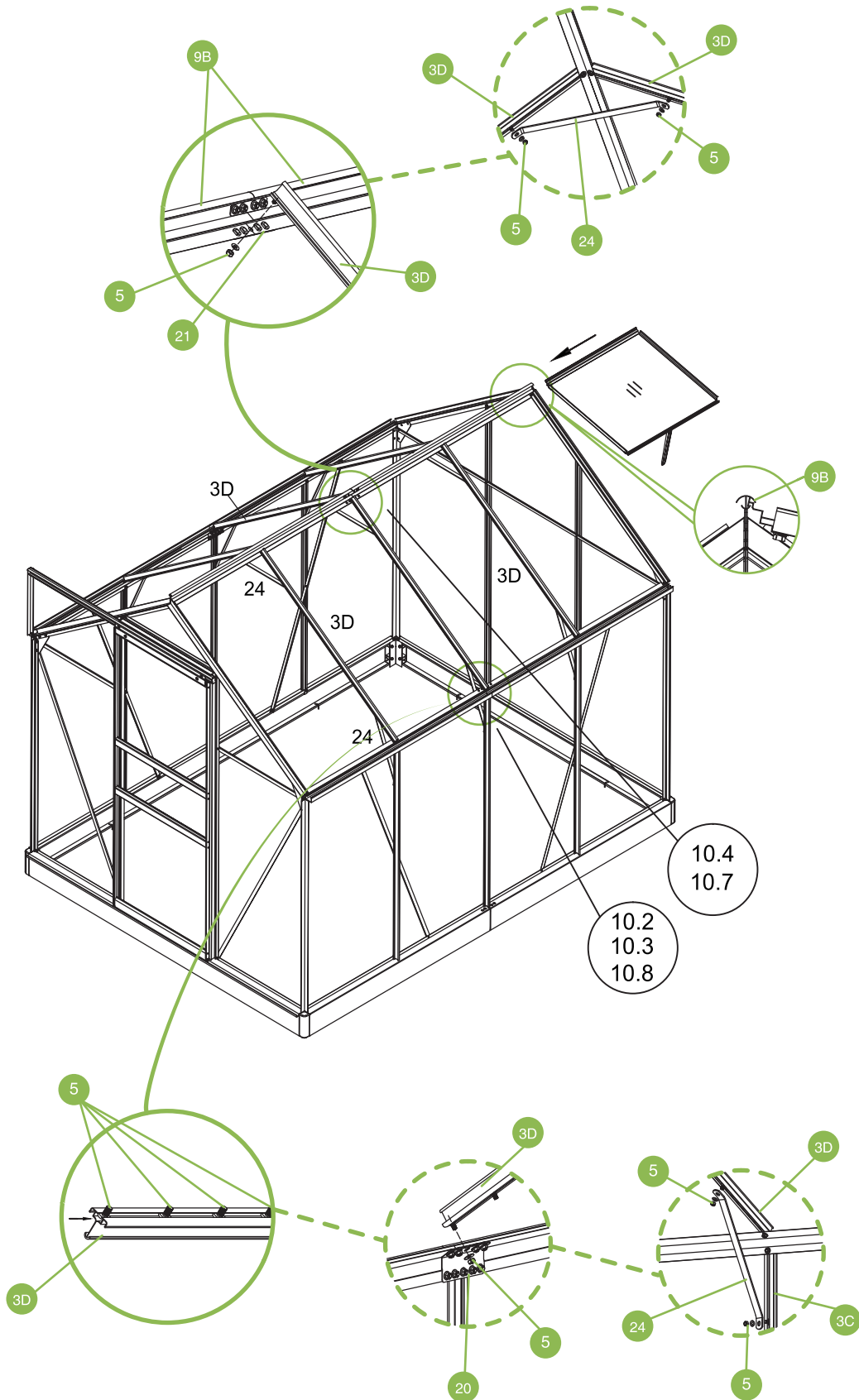

11

Inserting the skylights

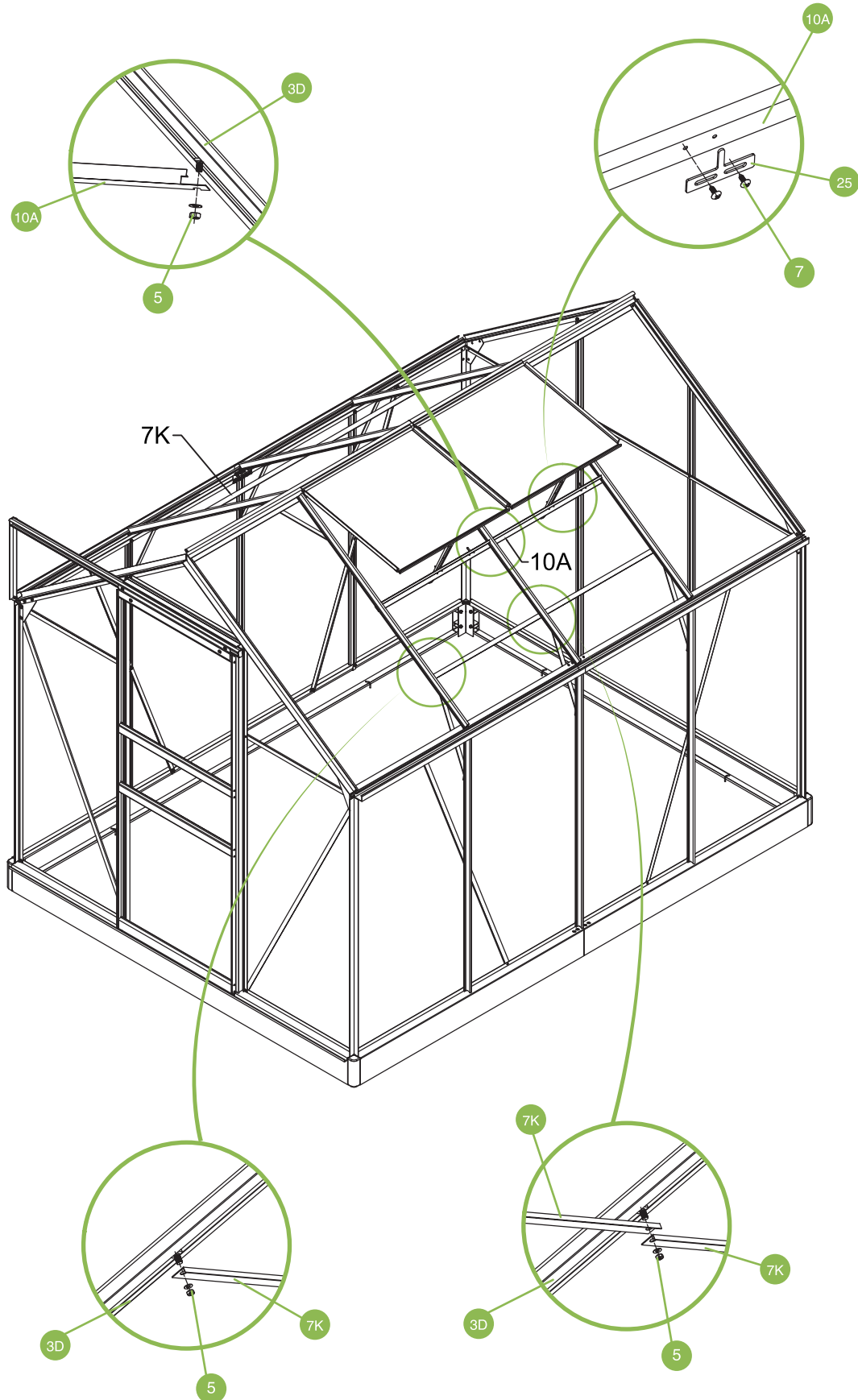

12

Insertion of the wall sheets

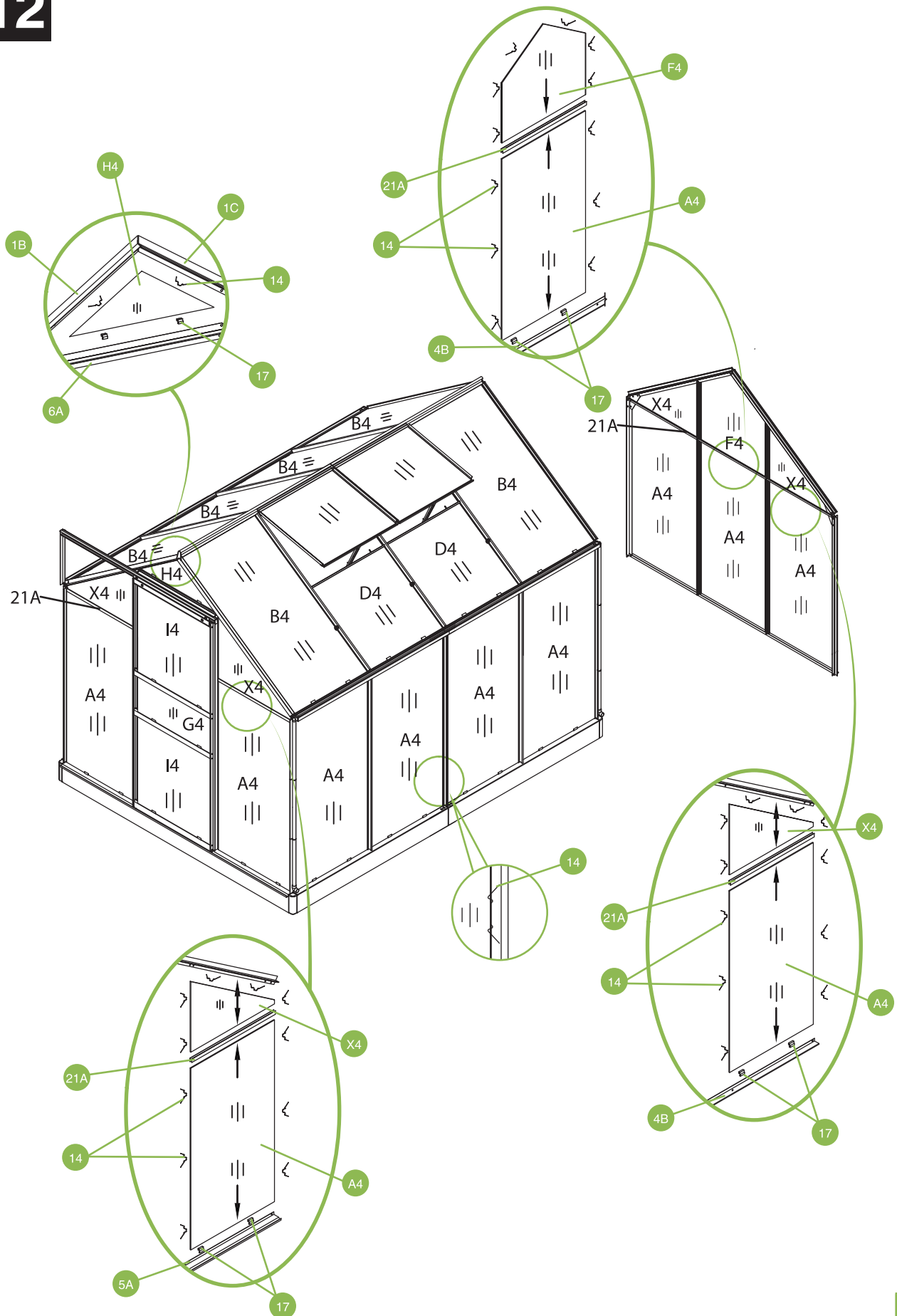

12

Insertion of the wall sheets

