

ASSEMBLY INSTRUCTIONS



JEWELRY CHEVAL MIRROR

ASSEMBLY INSTRUCTIONS

ASSEMBLY TIPS:

- 1.Remove hardware from box and sort by size.
- 2.Please check to see that all hardware and parts are present prior to start of assembly.
- 3.Please follow attached instruction in the same sequence as numbered to assure fast & easy assembly.



WARNING!

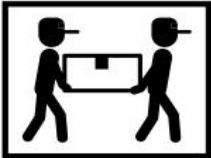

- 1.Don't attempt to repair or modify parts that are broken or defective. Please contact the store
- 2.This product is for home use only and not intended for commercial establishment.







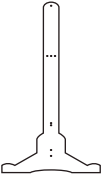

ASSEMBLY TIME

15 MINUTES

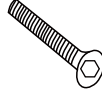
PARTS IDENTIFICATION:.

A		Mirror cabinet	1PCS
B		Leg	2PCS
C		Top crossbar	1PCS
D		Bottom crossbar	1PCS

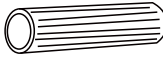
Z HARDWARE IDENTIFICATION

1		Long screws Ø0.5x4.5mm	6PCS
2		Bolts Ø1x1.1mm	6PCS
3		Main connecting screws Ø0.5x6.5mm	2PCS
4		Plastic washer Ø3mm	2PCS
5		Wooden dowel Ø0.8x3mm	4PCS
6		Allen key M6x6.7	1PCS

ASSEMBLY INSTRUCTIONS
STEP 1

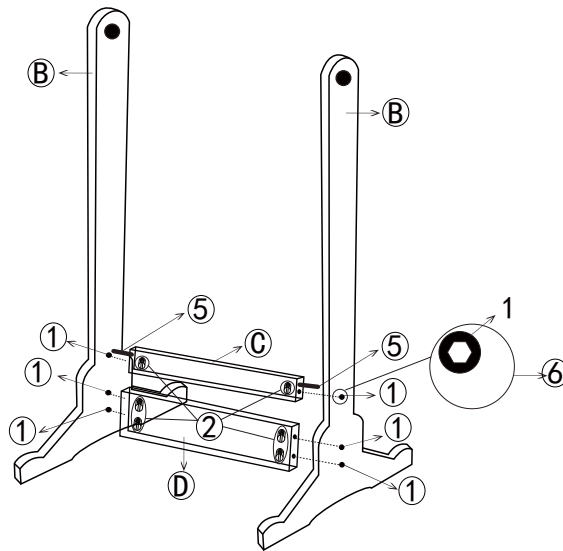

STEP 2

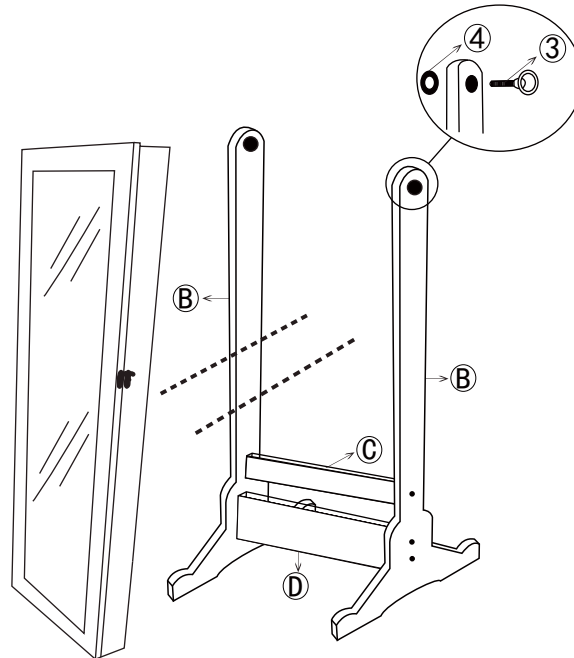

STEP 3

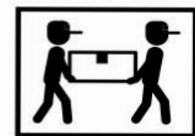
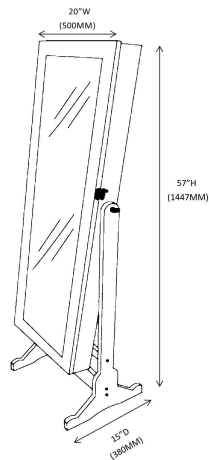

Note: Dimension tolerance $\pm 5\%$