

# 猫粘性高达98%

## Cat adhesion reaches up to 98%.

### 平均一次玩32分钟

On average, each play session lasts 32 minutes.

- **测试7个月解决落灰问题**
- 7 months of testing to solve the dust issue.
- **猫猫认可的猫爬架才能闪亮登场**
- Only cat-approved cat trees can shine on stage.

#### Important Notes:

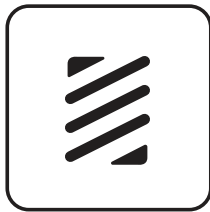

耐磨耐抓

Wear-resistant and  
scratch-resistant

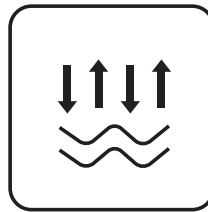

透气防滑

Breathable and non-slip

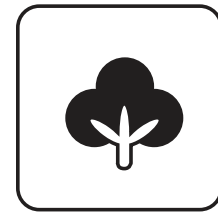

细腻触感

Delicate touch

#### 温馨提示:

由于猫爬架是大件物品，如果在发货后因为个人原因拦截或拒收，退回的运费将由您自行承担。不过，如果您的猫突然决定不喜欢它，欢迎来店铺选择其他款式，我们为您优惠！感谢您的理解与配合！

#### Kind reminder:

As the cat tree is large, if you intercept or reject it for personal reasons after dispatch, you'll bear the return shipping cost. If your cat doesn't like it, visit our store for other styles with a discount. Thanks for your understanding!

**稳只是基础**  
STABILITY IS JUST THE START —  
**爱玩才不落灰**  
PLAYFULNESS KEEPS THE DUST AWAY.  
**玩睡兼备 大户必备**  
PLAY AND REST, A MUST-HAVE FOR THE SPACIOUS HOME.  
**让每只猫咪的梦境都不在摇晃**  
ENSURING EVERY CAT'S DREAMS ARE STEADY AND CALM.

**关于气味 / About Odor**

天然材料有其独特香气，长时间封闭在不透气环境中可能会有少量气味。可将产品放在通风处晾几天以减轻气味。所有材质符合E0环保标准，对人类和猫咪安全。  
Natural materials has its own fragrance. If stored in an airtight environment, a slight odor may develop. Place the product in a well-ventilated area for a few days to reduce this. All materials meet E0 environmental standards and are safe for both humans and cats.

**关于掉毛 / About Shedding**

部分猫爬架配件使用短毛绒面料，可能有少量浮毛。只需轻拍或用除毛刷清理即可。  
Some of the matching cushions/hammocks are made from short-plush fabric, which may shed a little. Simply pat the product or use a de-shedding brush to remove the loose fibers.

**关于剑麻绳和牛皮纸绳 /  
About Sisal Rope and Kraft Paper Rope**

剑麻绳有天然酸味，手感粗糙，摩擦力强，耐磨且掉屑少。牛皮纸绳平滑、不易发霉，易清理且更加耐用、美观。  
Sisal rope has a natural sour smell and rough texture, offering strong friction, wear resistance, and minimal shedding. Kraft paper rope is smooth, mildew-resistant, easy to clean, and more aesthetically pleasing, while also being durable and safe.

**关于摇晃/Regarding shaking**

由于爬架较高，受到物理外力的影响时，中上层可能有轻微晃动，是正常现象，属于安全范围。螺丝未拧紧，或者两块瓷砖/木地板之间有轻微高低差，也可能导致猫爬架有轻微晃动。您可通过拧紧螺丝或者在猫爬架底部放置地毯来改善轻微的摇晃现象。  
About Swaying  
Since the cat tree is relatively tall, when it is affected by physical external forces, the middle and upper layers may sway slightly. This is a normal phenomenon and within the safe range. Loose screws, or a slight height difference between two tiles/wooden floors, may also cause the cat tree to sway slightly. You can improve the slight swaying phenomenon by tightening the screws or placing a carpet at the bottom of the cat tree.

**爬架部件可单独购买? Components of the cat tree can be purchased separately?**

已购爬架的客户均可以成本价单独购买配件无需更换整个爬架，更节省  
Customers who have purchased the cat tree can buy accessories separately at cost price without replacing the entire cat tree, which is more cost-effective.



**探索人与宠物的生活空间关系，专注猫爬架、猫窝设计生产16年，打造宠物的理想家，与家具融为一体，是福乐迪设计师们为之努力的目标，如今国内外已有近1000项外观设计，在国内外35个国家及地区销售。**

Exploring the relationship between people and pets in living spaces, we have been focusing on the design and production of cat trees and cat beds for 16 years. Our goal is to create the ideal home for pets, seamlessly blending with furniture.

Today, we hold nearly 1,000 design patents and our products are sold in 35 countries and regions worldwide.

**1000+**

国内外专利设计

Domestic and International  
Patented Designs

**40000m<sup>2</sup>**

现代化生产基地

Modern Production Base

**35+**

出口国家和地区



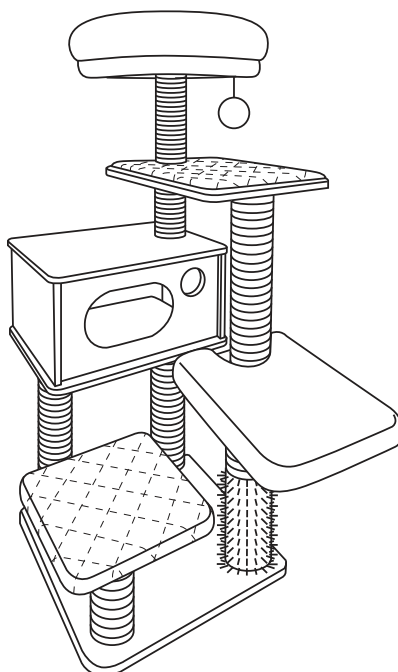



Export Countries and  
Regions

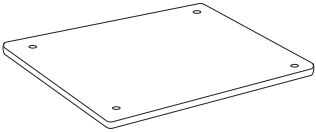
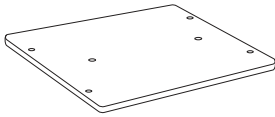
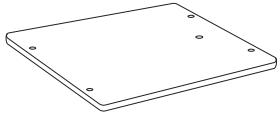
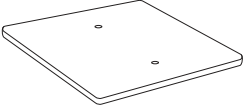
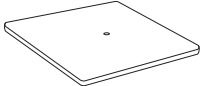
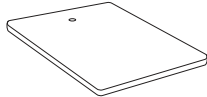
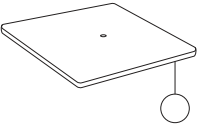
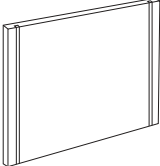
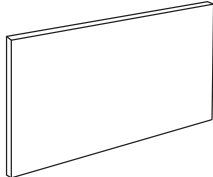
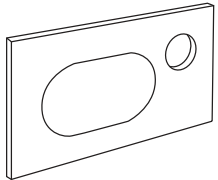
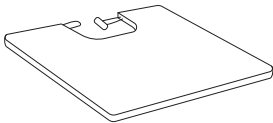
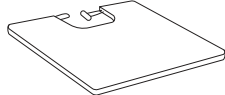
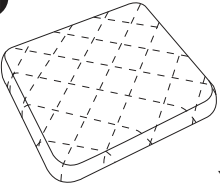
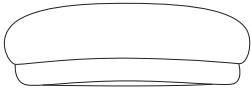
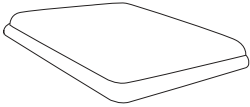

## User's Manual

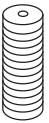
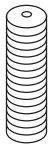
Please read this manual carefully before using the product.

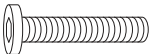
Please carefully keep this instruction manual for reference after reading.

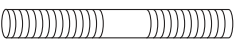
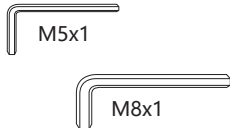
<p><b>A</b></p>  <p>X1</p>	<p><b>B</b></p>  <p>X1</p>	<p><b>C</b></p>  <p>X1</p>	
<p><b>D</b></p>  <p>X1</p>	<p><b>E</b></p>  <p>X1</p>	<p><b>F</b></p>  <p>X1</p>	
<p><b>G</b> <math>\Phi 8.5 \times 18 \text{cm}</math></p>  <p>X1</p>	<p><b>H</b> <math>\Phi 8.5 \times 25 \text{cm}</math></p>  <p>X2</p>	<p><b>I</b></p>  <p>X1</p>	
<p><b>J</b></p>  <p>X1</p>	<p><b>K</b></p>  <p>X1</p>	<p><b>L</b></p>  <p>X1</p>	
<p><b>M</b></p>  <p>X1</p>	<p><b>N</b></p>  <p>X1</p>	<p><b>O</b></p>  <p>X1</p>	<p><b>P</b> <math>\Phi 8.5 \times 47.5 \text{cm}</math></p>  <p>X1</p>
<p><b>Q</b> <math>\Phi 8.5 \times 47.5 \text{cm}</math></p>  <p>X3</p>	<p><b>R</b> <math>\Phi 8.5 \times 21.5 \text{cm}</math></p>  <p>X1</p>	<p><b>S</b> <math>\Phi 8.5 \times 28.5 \text{cm}</math></p>  <p>X2</p>	<p><b>T</b></p>  <p>X1</p>
<p><b>1</b> M8x50mm</p>  <p>X9</p>	<p><b>2</b> M5x28mm</p>  <p>X8</p>	<p><b>3</b> M8x60mm</p>  <p>X2</p>	<p><b>4</b></p>  <p>M5x1 M8x1</p>

Product Size: 48\*48\*134cm

Product weight: 20kg

Dimensional drawing of columns

Unit: centimeters

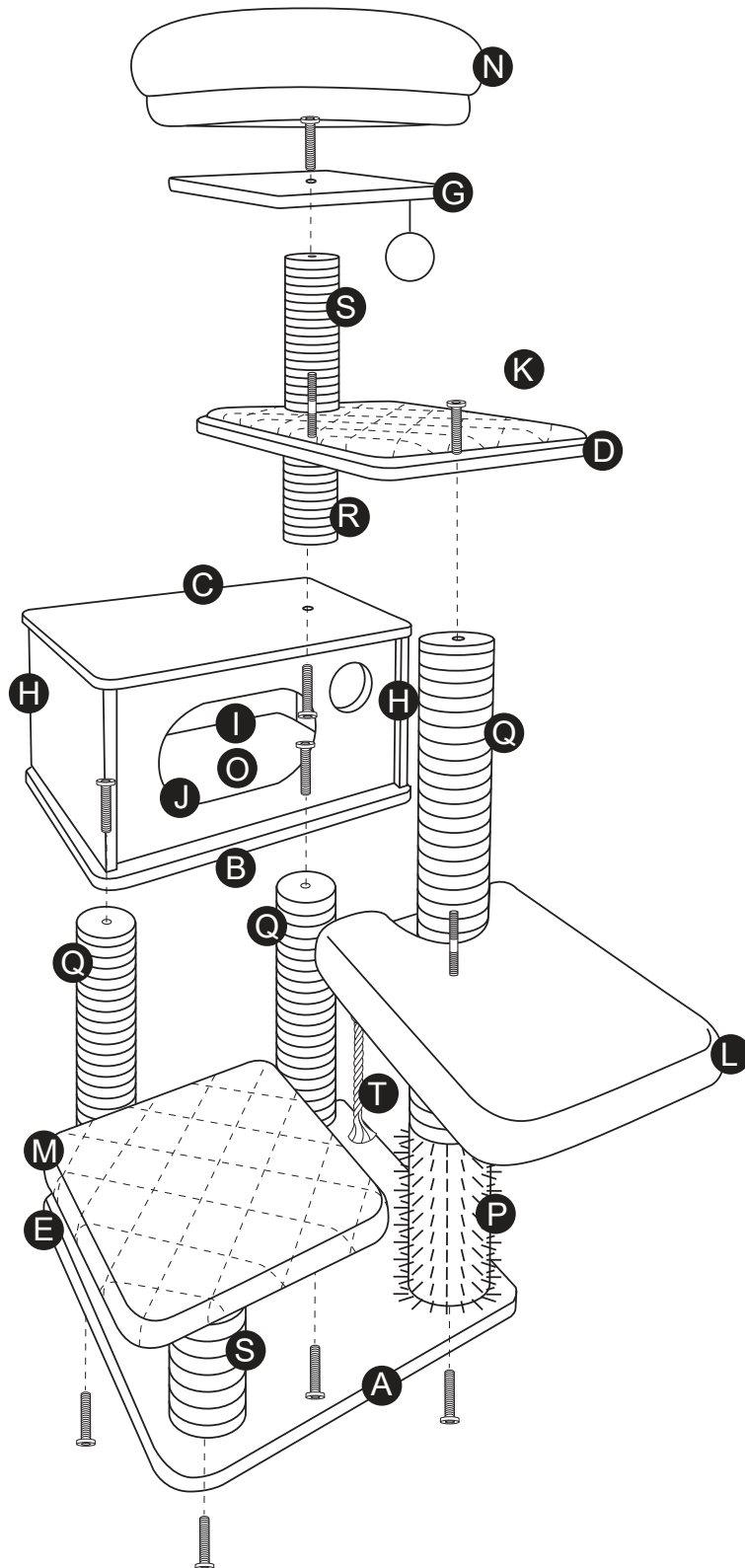
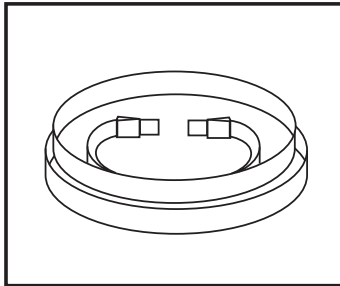

- ① Install as shown in the figure, tighten the screws to fix. Put on the accessory M, or put it on after the installation is completed.

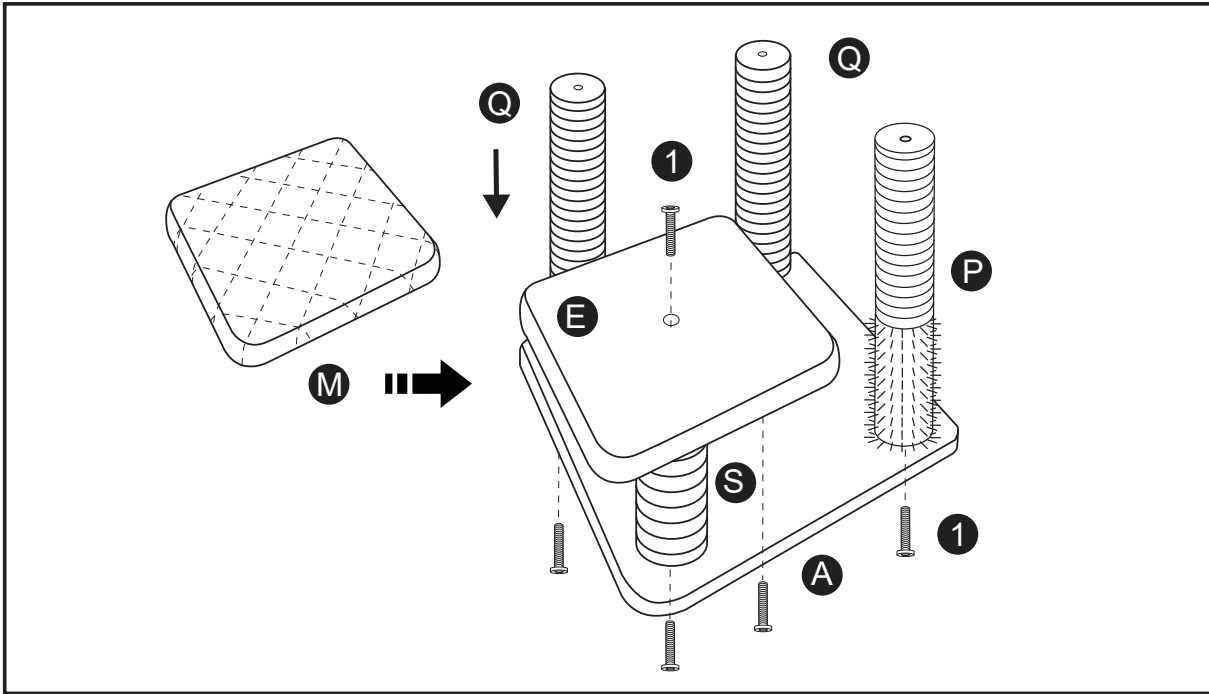

- ② To install the room, first install the bottom and two side panels, then insert the front and back panels, cover the top, and tighten the screws to fix.

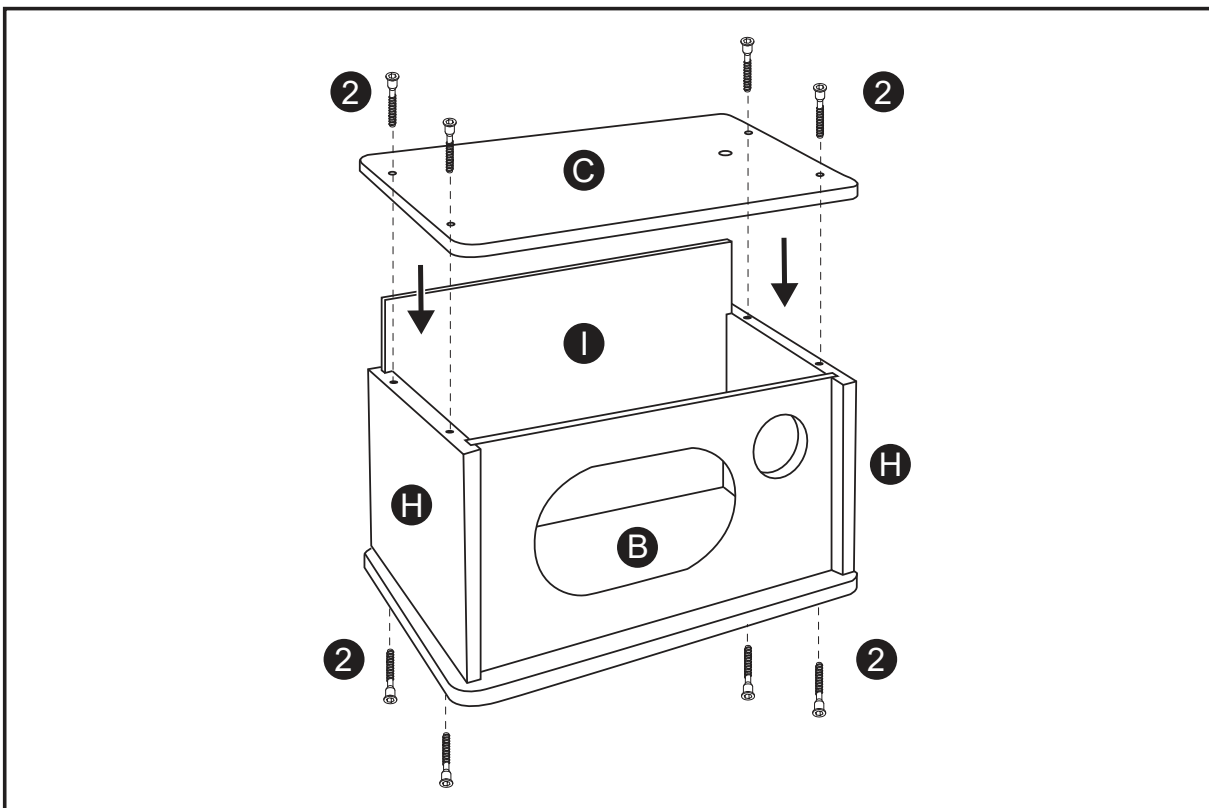



- ⑤ Install the top floor, tighten the screws to fix, and then put on accessory N, as shown in the figure.

