

OFFICE CHAIR ASSEMBLY INSTRUCTION

<http://www.paylesshere.com>

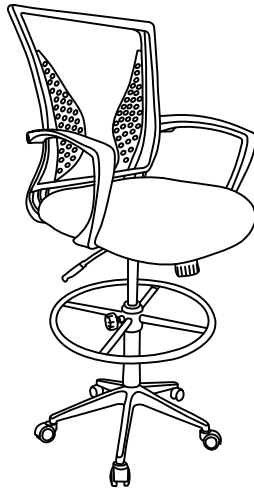

THANK YOU FOR PURCHASING OFFICE CHAIR OC-20DF2 PARTS LIST

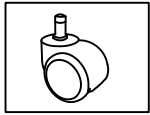

A 5×Wheels

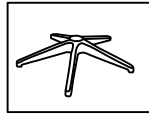

B1 1×base

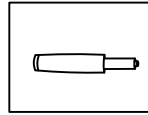

C1 1×gas lift

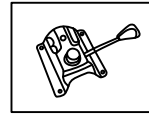

D1×mechanism

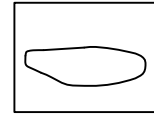

E1×seat



F1×back

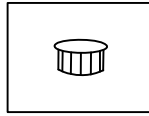

G2×Plastic caps

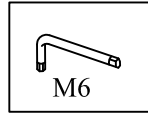

H1×allen key
M6

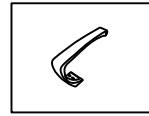

I1 Left armrests

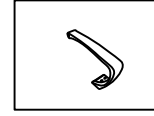

I2 Right armrests

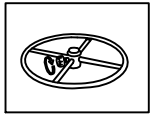

M11×Foot ring

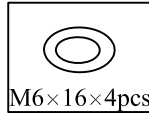

O14×washers
M6×16×4pcs

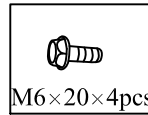

Z8 4×screws
M6×20×4pcs

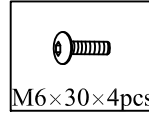

Z16 4×screws
M6×30×4pcs

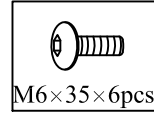

Z19 6×screws
M6×35×6pcs

WARNING

- Do not stand in this chair or use the chair as a step ladder use it as chair only.
- This chair is designed for one person to use at a time.
- This chair is designed for one person weighing up to 250lbs(113kgs).
- Do not use this chair unless all bolts, screws and knobs are firmly secured.
- Check all bolts,screws and knobs every 90days. Tighten if any are loose.
- Failure to follow these instructions may result in serious injury or death of yourself and people around you.
- Some of the part are heavy and/or has shape edge, please install it carefully to avoid hurt you and people around you.

1

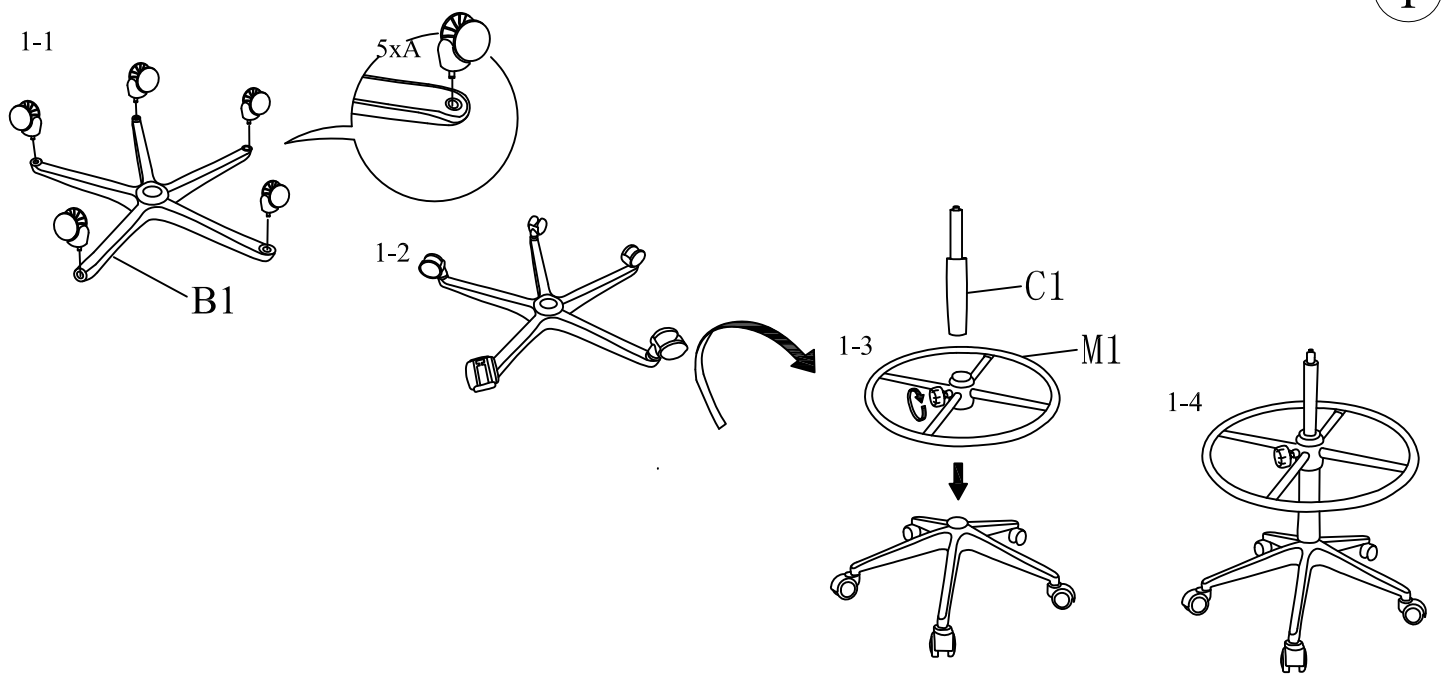

2

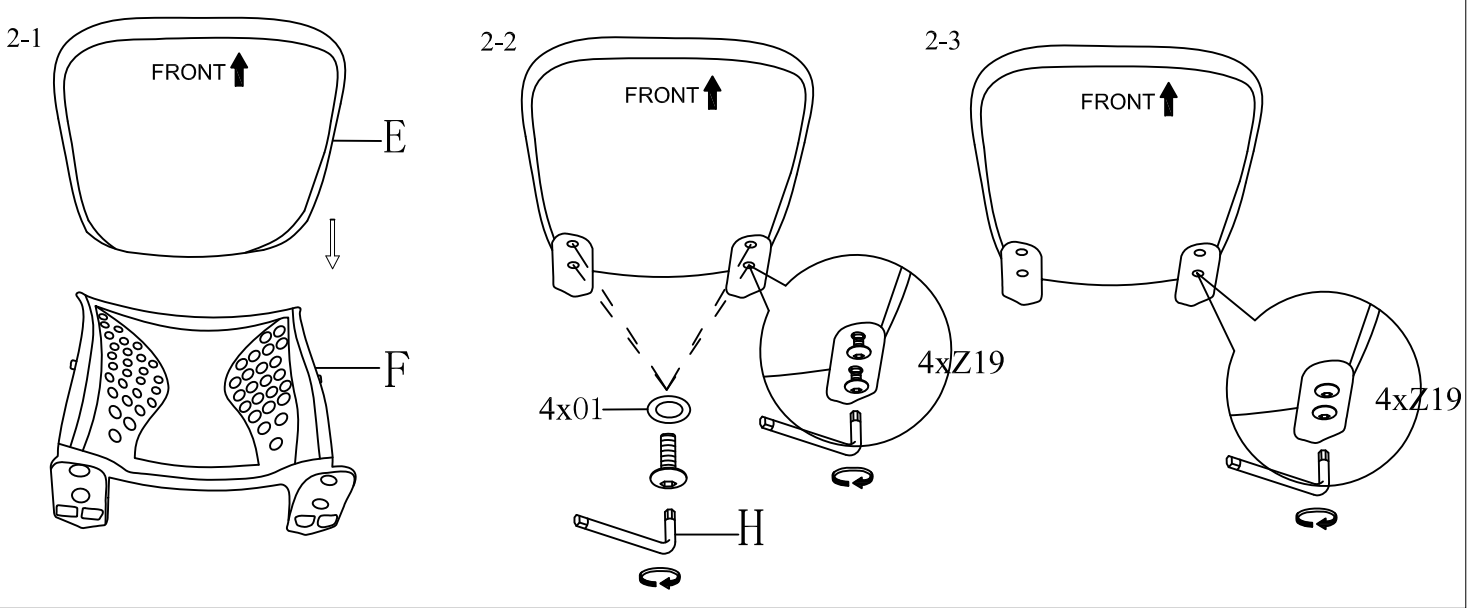

3

