











Assembly Instruction

Instructions d'assemblage

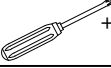
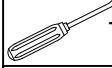
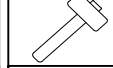
3 Tier Book Shelf

Etagère à livres à 3 niveaux

 REQUIRED ASSEMBLY TOOLS	 REQUIRED ASSEMBLY TOOLS	 REQUIRED ASSEMBLY TOOLS	 REQUIRED ASSEMBLY TOOLS	 NO POWER TOOLS NEEDED	 2 PERSON ASSEMBLY
 OUTILS D'ASSEMBLAGE NÉCESSAIRES	 OUTILS D'ASSEMBLAGE NÉCESSAIRES	 OUTILS D'ASSEMBLAGE NÉCESSAIRES	 OUTILS D'ASSEMBLAGE NÉCESSAIRES	 AUCUN OUTIL ÉLECTRIQUE N'EST NÉCESSAIRE	 ASSEMBLAGE PAR 2 PERSONNES

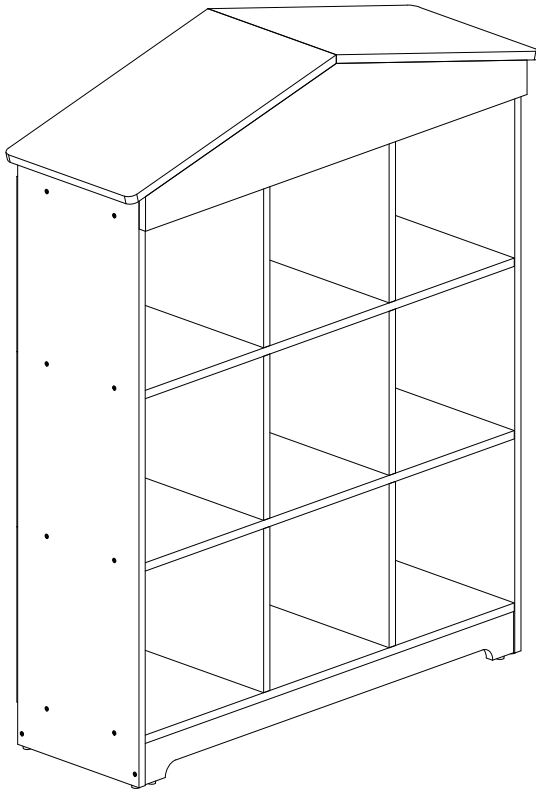

FRONT VIEW
Vue de Face

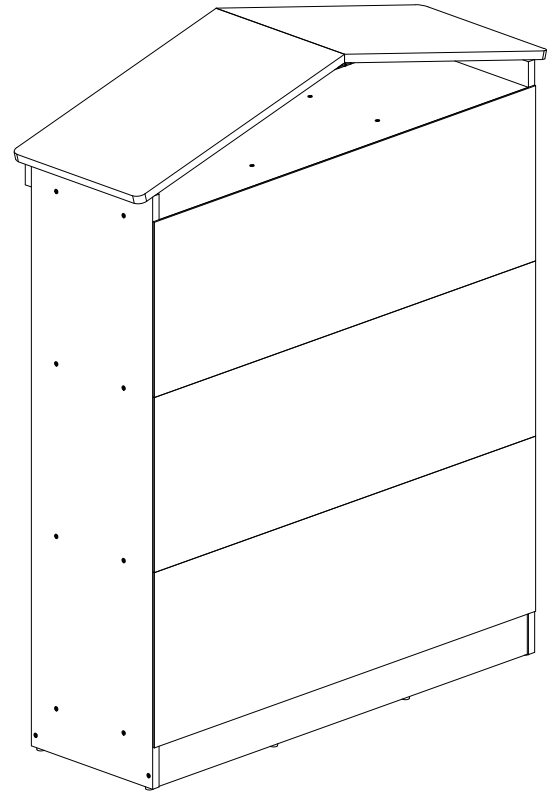

BACK VIEW
Vue arrière

Product Dimensions: Height 47.44" x Width 37.08" x Depth 12.04"

Dimensions du produit : Hauteur 47.44" x Largeur 37.08" x Profondeur 12.04"

The Breakdown

La répartition

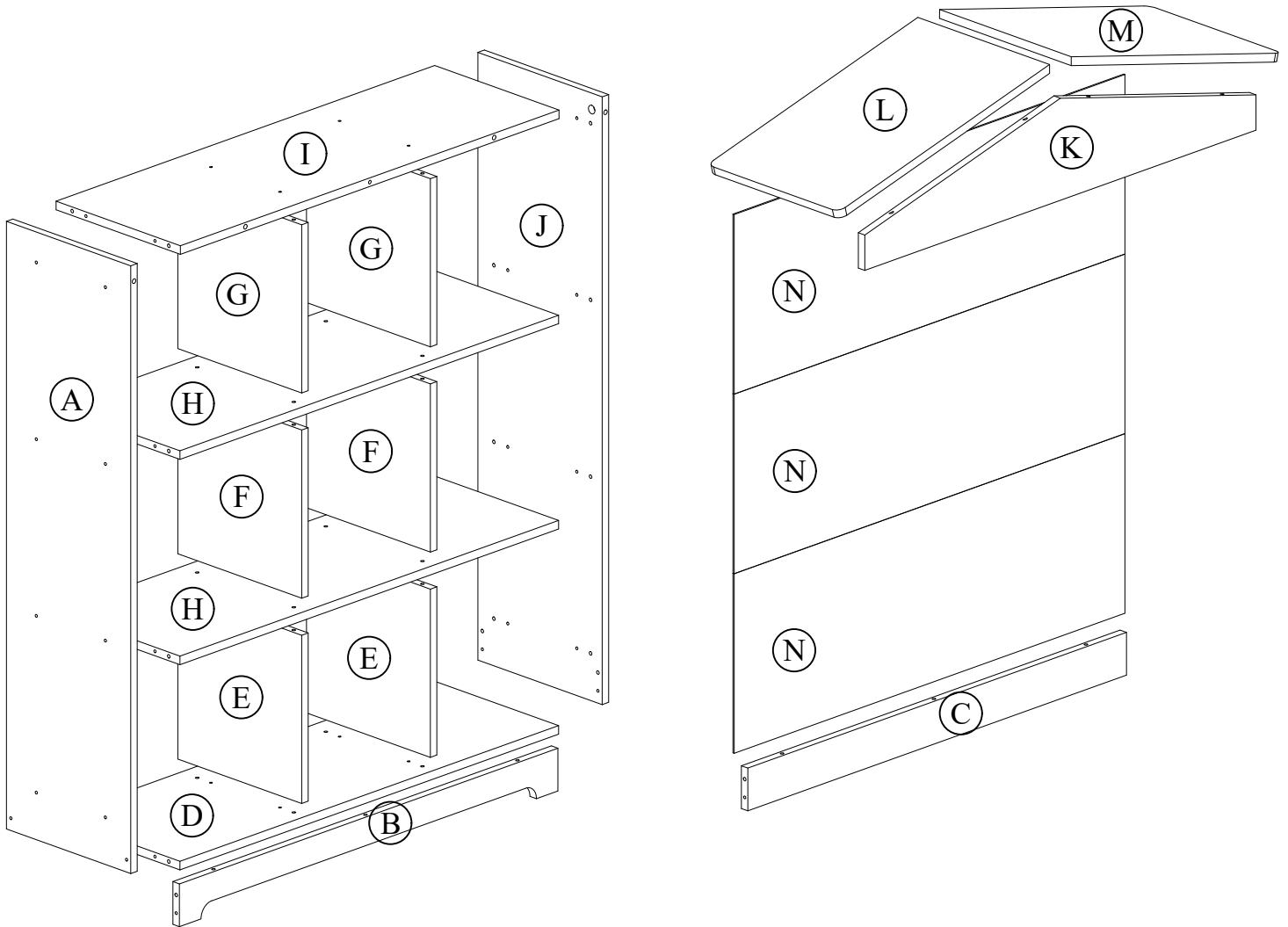

Assembly Instruction

Instructions d'assemblage

Parts List

Liste des pièces

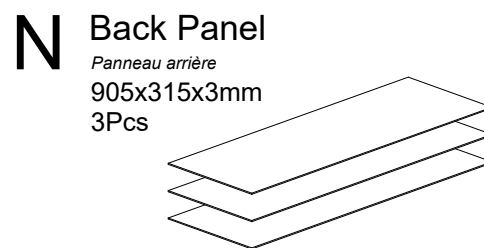
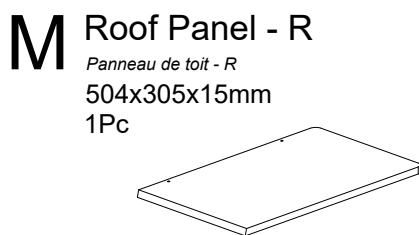
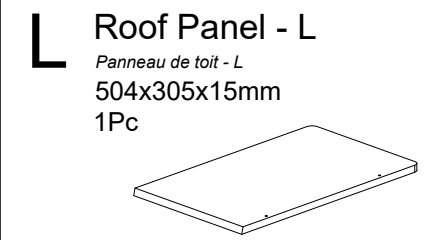
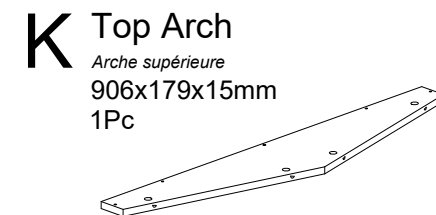
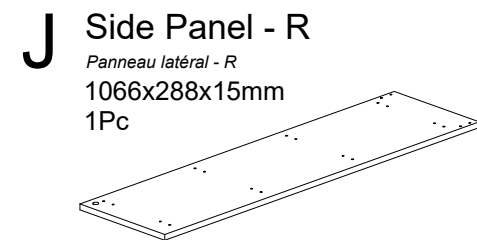
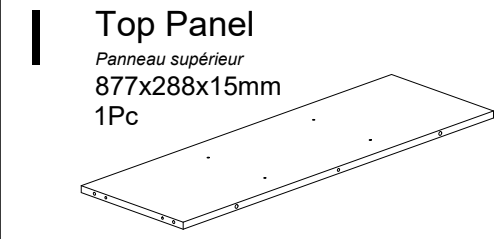
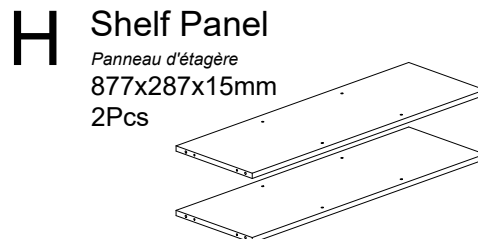
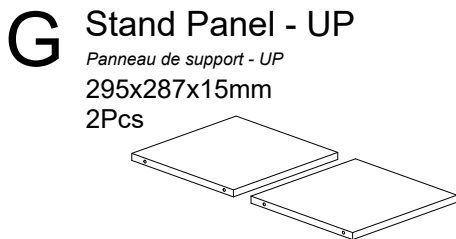
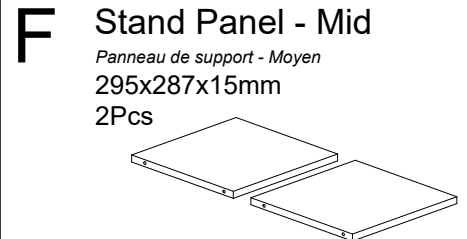
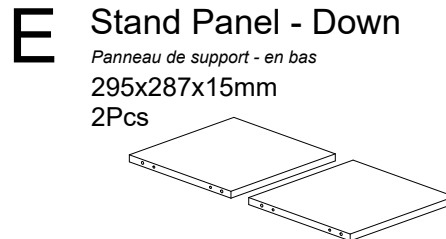
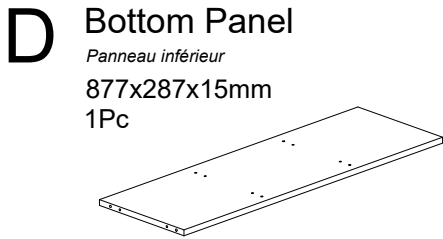
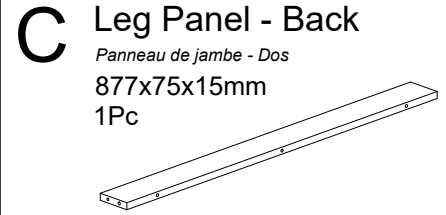
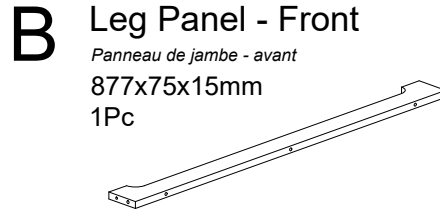
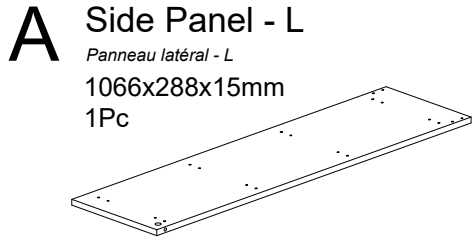

Assembly Instruction

Instructions d'assemblage

Hardware List

Liste du matériel

<i>No.</i> <i>No.</i>	<i>SHAPE</i> <i>FORME</i>	<i>DESCRIPTION</i> <i>DESCRIPTIO</i>	<i>Qty.</i> <i>Quantité</i>
1		6x25mm PVC Dowel <i>Cheville en PVC 6x25mm</i>	51Pcs
2		M3.5x14mm Screw <i>Vis M3.5x14mm</i>	4Pcs
3		M6x40mm Screw <i>Vis M6x40mm</i>	28Pcs
4		15MM Screw Cap <i>Capuchon à vis 15MM</i>	28Pcs
5	 5a 5b	15MM Myfix Minifix <i>15MM Myfix Minifix</i>	8Sets
6		17 MM MiniFix Cap <i>17 MM MiniFix Capuchon</i>	8Pcs
7		Metal Hinges (4Holes) <i>Charnières en métal (4 trous)</i>	1Pc
8		Nail Leg <i>Clou de jambe</i>	8Pcs
9		Nail <i>Clou</i>	84Pcs
10		M4 Allen Key <i>Clé Allen M4</i>	1Pc

Assembly Instruction

Instructions d'assemblage

Step 1

Étape 1

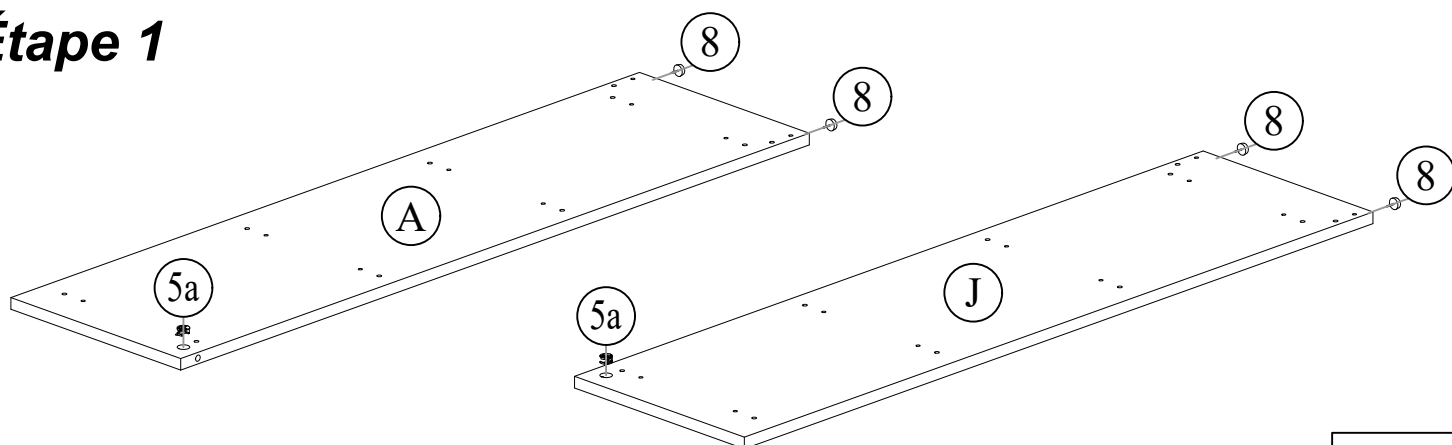

- Install the minifix nuts (5a) & nail legs (8) at both panel (A) & (J).
Installer les écrous minifix (5a) et les pattes de clouage (8) sur les deux panneaux (A) et (J).

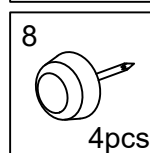
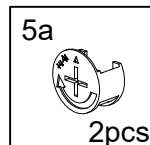

Step 2

Étape 2

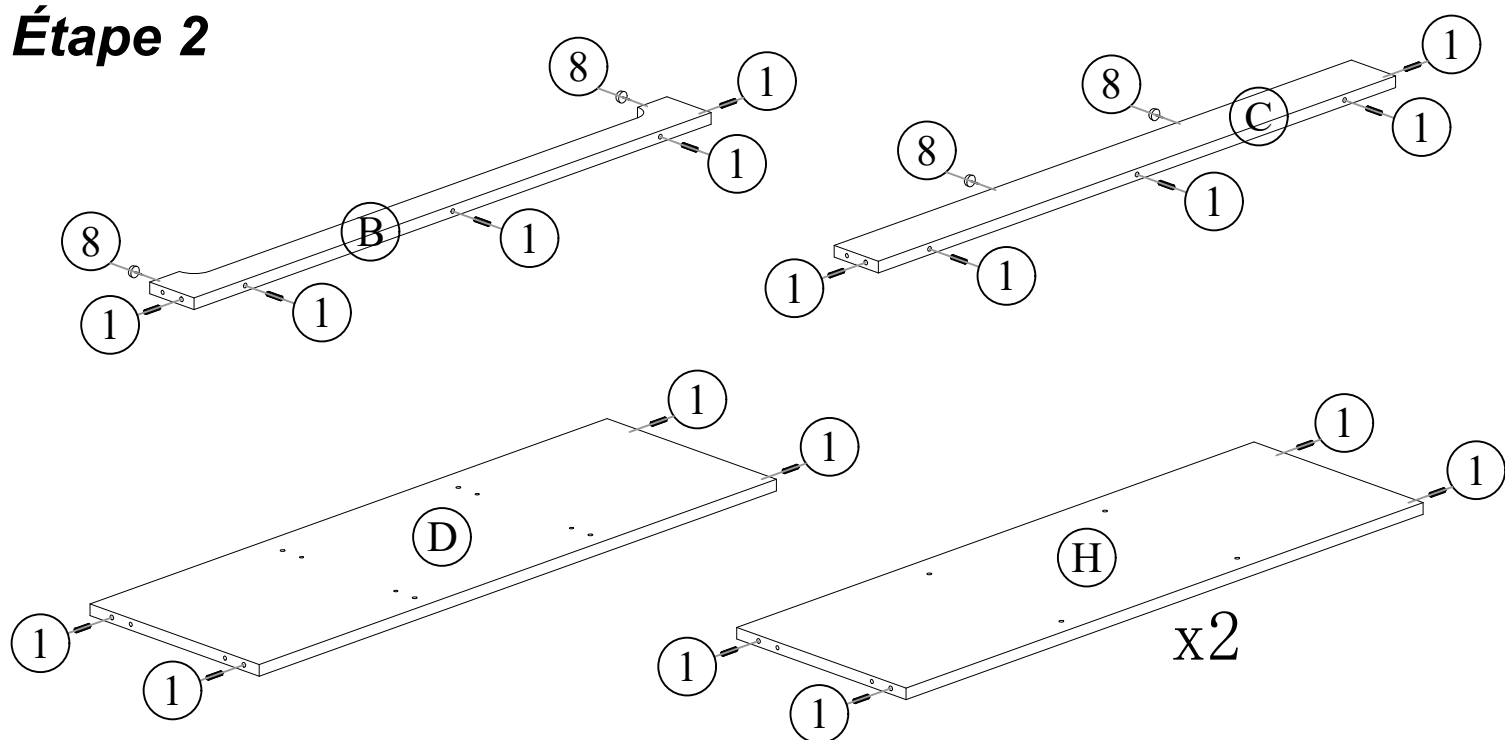

- Install the 6x25mm PVC dowel (1) to Panel (B), (C), (D) & (H).
Installer la cheville en PVC 6x25mm (1) sur les panneaux (B), (C), (D) & (H).

- Next, install nail legs (8) to Panel (B) & (C).
Ensuite, installez les pattes de clouage (8) sur les panneaux (B) & (C).

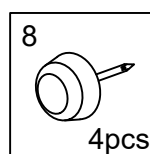
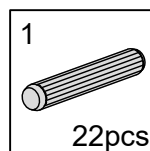

Assembly Instruction

Instructions d'assemblage

Step 3

Étape 3

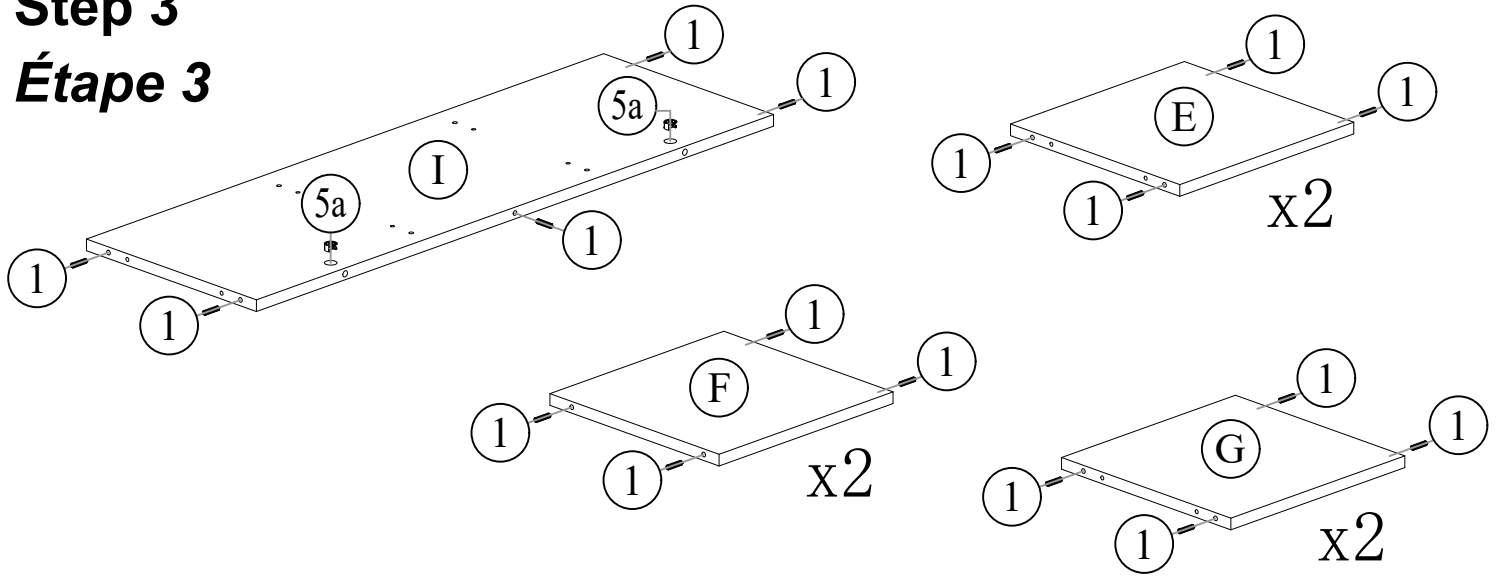

- Install the 6x25mm PVC dowel (1) to Panel (E), (F), (G) & (I).
Installer la cheville en PVC 6x25mm (1) sur les panneaux (E), (F), (G) & (I).
- Install the minifix nuts (5a) at Panel (I).
Installer les écrous minifix (5a) sur le panneau (I).

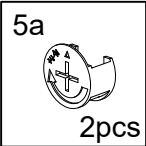
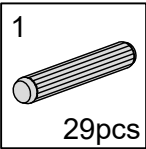

Step 4

Étape 4

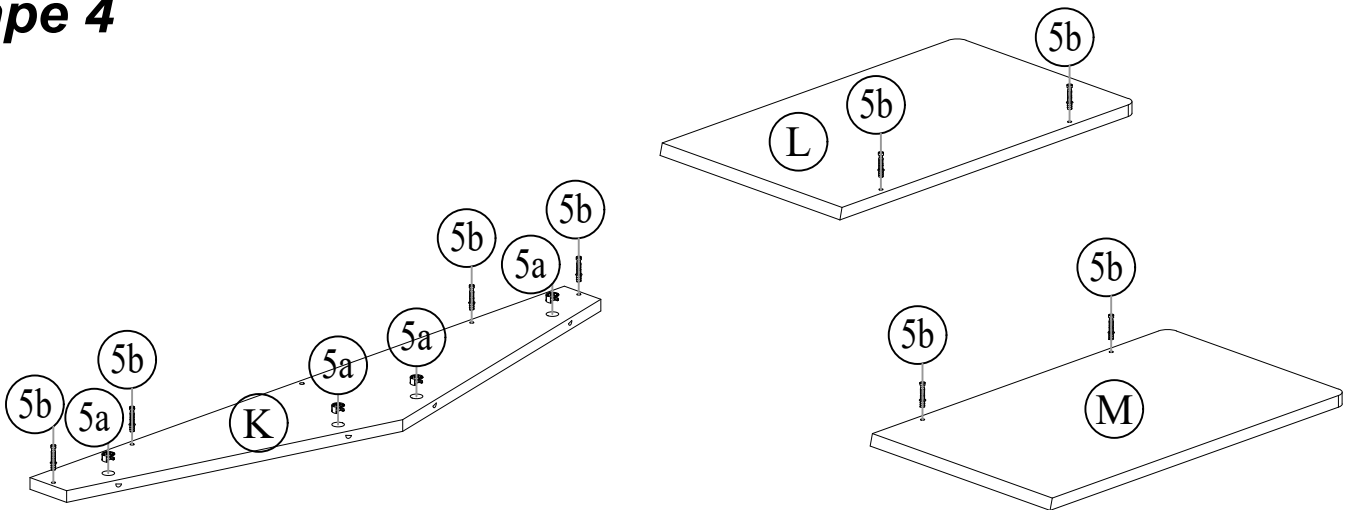

- Install the minifix nuts (5a) at Panel (K).
Installer les écrous minifix (5a) sur le panneau (K).
- Install the minifix screws (5b) at Panel (K), (L) & (M).
Installer les vis minifix (5b) sur les panneaux (K), (L) & (M).

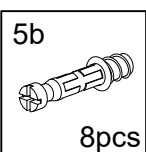
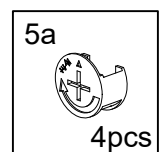

Assembly Instruction

Instructions d'assemblage

Step 5

Étape 5

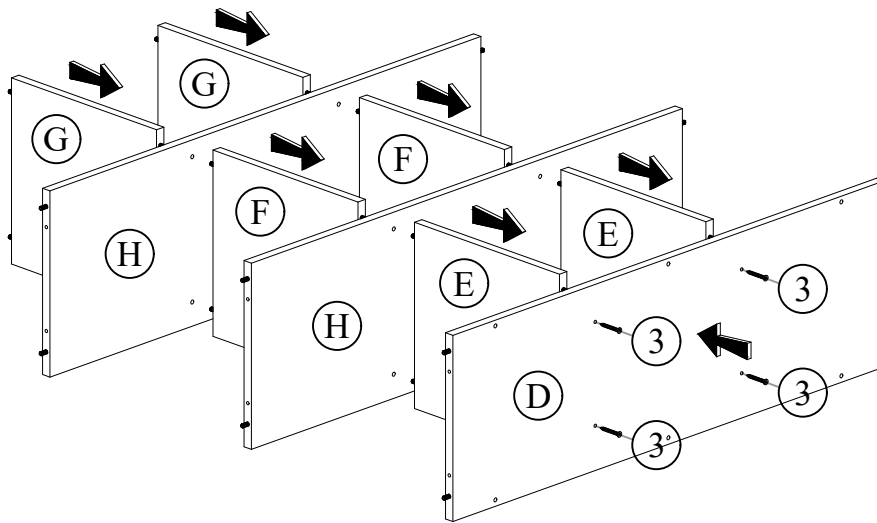

- Start assembly Panel (D) with Panel (E) & secure the panels with M6x40mm screws (3). Then, assemble Panel (H) to Panel (E) & continue with Panel (F), (H) & (G).

Commencez par assembler le panneau (D) avec le panneau (E) et fixez les panneaux avec des vis M6x40mm (3). Assemblez ensuite le panneau (H) au panneau (E) et continuez avec les panneaux (F), (H) et (G).

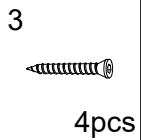

Step 6

Étape 6

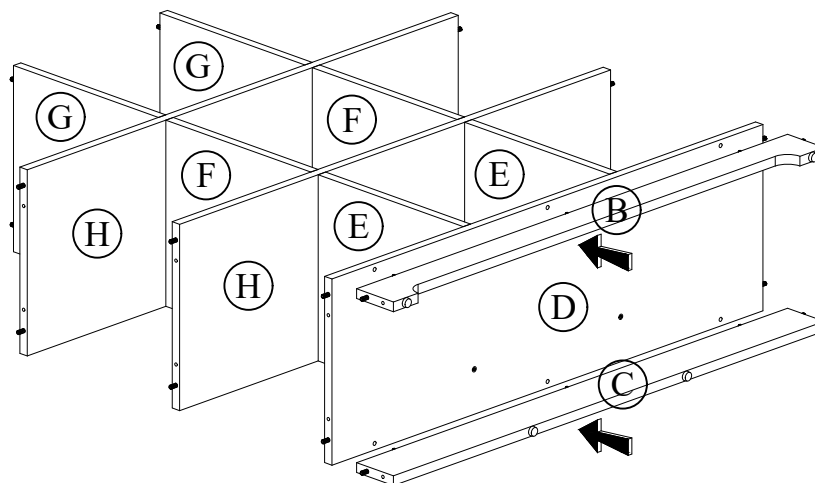

- Next, assemble Panel (B) & (C) to Panel (D). Make sure the panels are well-fitted to the holes.

Ensuite, assemblez les panneaux (B) & (C) au panneau (D). Assurez-vous que les panneaux sont bien ajustés aux trous.

Step 7 ←



Assembly Instruction

Instructions d'assemblage

Step 7

Étape 7

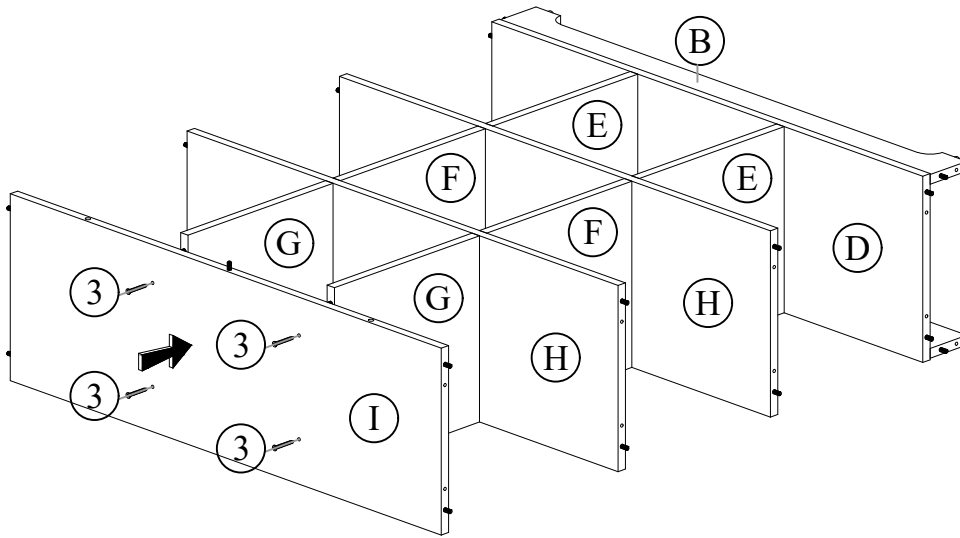

- Turn 90° & continue assemble Panel (G) to Panel (I) . Secure them with M6x40mm screws (3) .

Tourner de 90° et continuer à assembler le panneau (G) au panneau (I) . Les fixer avec des vis M6x40mm (3) .

3



4pcs

Step 8

Étape 8

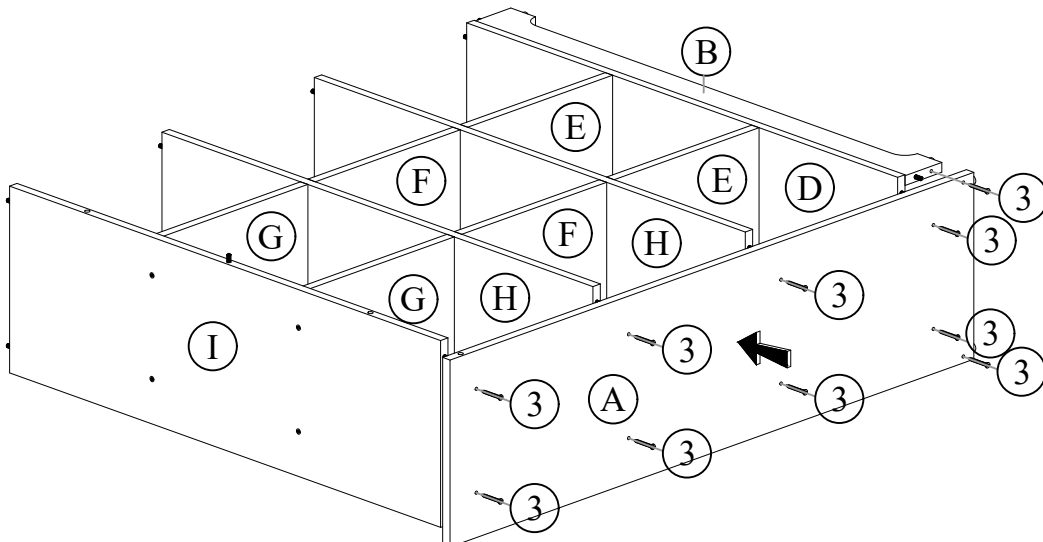

- Assemble Panel (A) to Panel (B), (C), (D), (H) & (I) . Secure with M6x40mm screws (3) .

Assembler le panneau (A) au panneau (B), (C), (D), (H) & (I) . Fixer avec les vis M6x40mm (3) .

3



10pcs

Step 9 ←

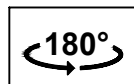

Assembly Instruction

Instructions d'assemblage

Step 9

Étape 9

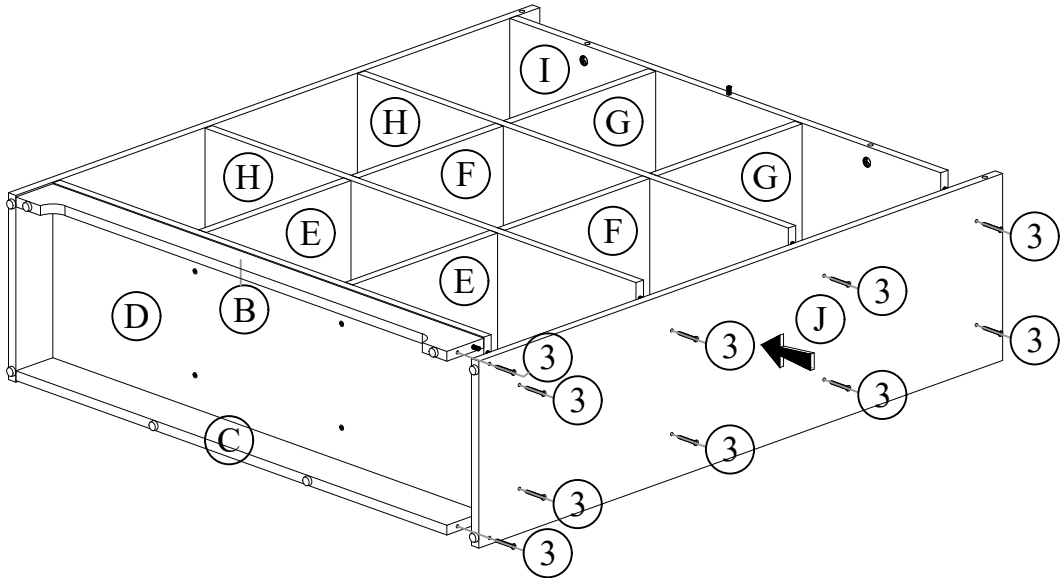

- Turn 180° & continue assemble Panel (J) to Panel (B), (C), (D), (H) & (I) .
Secure them with M6x40mm screws (3) .
*Tourner de 180° et continuer à assembler le panneau (J) au
panneau (B), (C), (D), (H) & (I). Les fixer avec des vis M6x40mm (3) .*

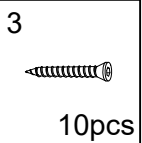

Step 10

Étape 10

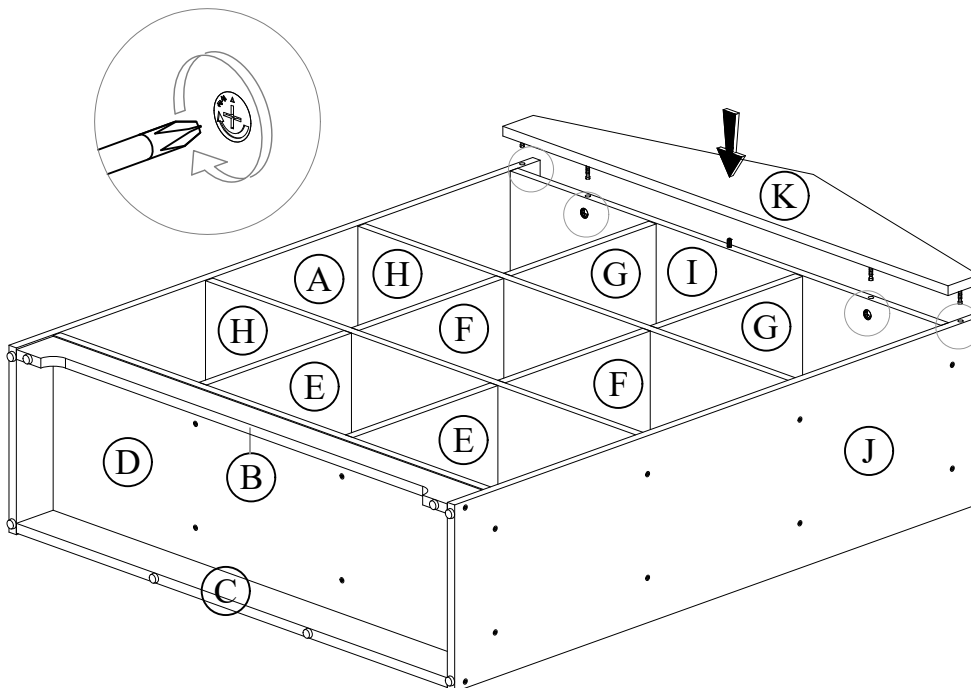

- Next, assemble Panel (K) to Panel (A), (I) & (J) . Rotate the minifix nuts as shown in the diagram to tighten the minifix screws.
Ensuite, assemblez le panneau (K) au panneau (A), (I) & (J). Tournez les écrous minifix comme indiqué dans le diagramme pour serrer les vis minifix.

Step 9 ←

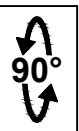

Step 11

Étape 11

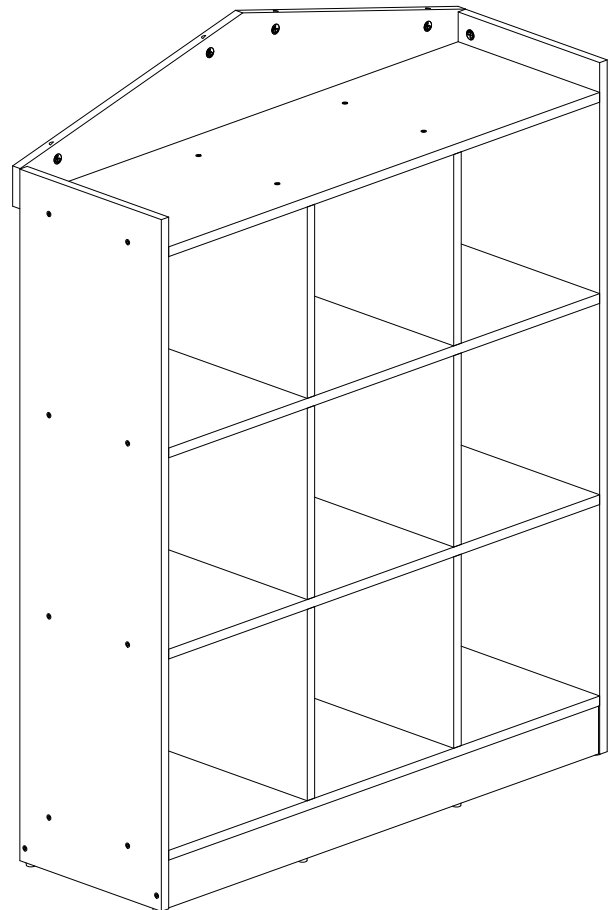
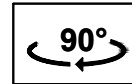
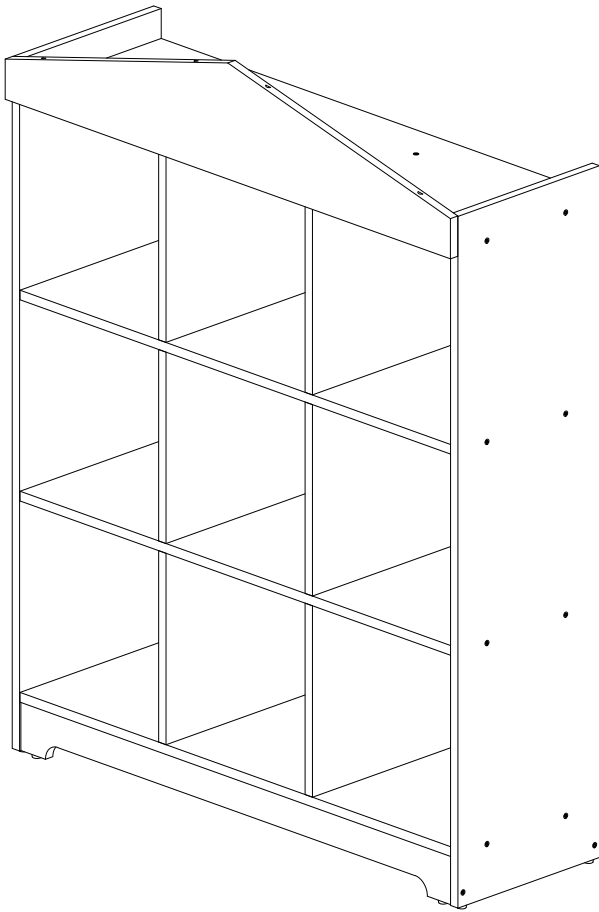

Assembly Instruction

Instructions d'assemblage

Step 12

Étape 12

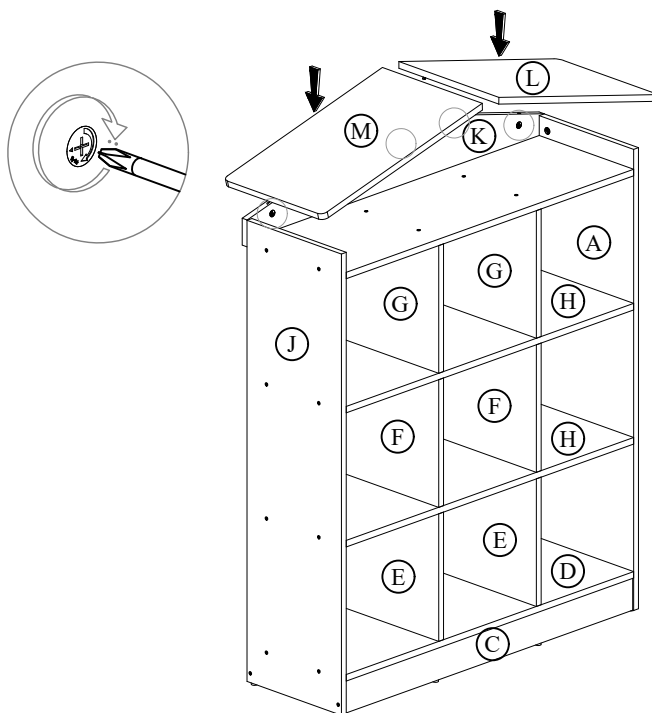

- Assemble Panel (L) & (M) to Panel (K). Rotate the minifix nuts to tighten the minifix screws as shown in the diagram.
Assembler les panneaux (L) et (M) au panneau (K). Tourner les écrous minifix pour serrer les vis minifix comme indiqué dans le diagramme.

Step 13

Étape 13

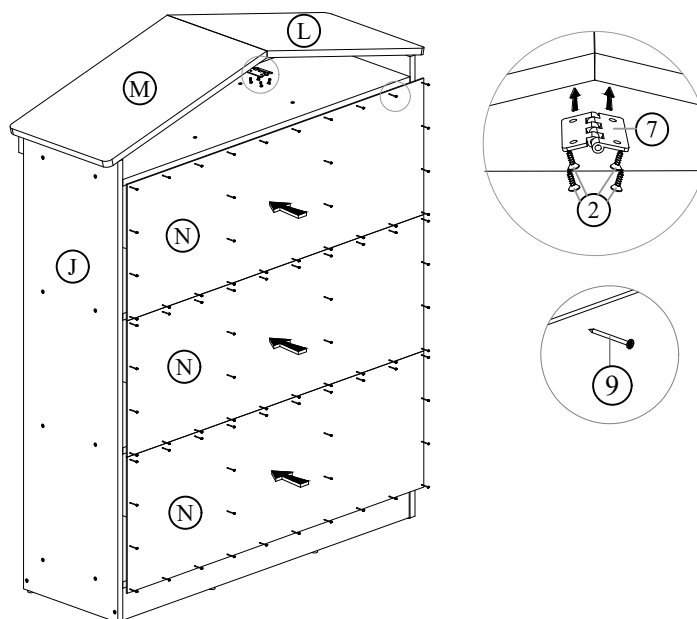

- Assembly Panel (N) to Panel (A), (D), (H), (I) & (J). Make sure it is evenly positioned before secure with nails (9).
Assembler le panneau (N) au panneau (A), (D), (H), (I) & (J). S'assurer qu'il est bien positionné avant de le fixer à l'aide de clous (9).
- Install Metal Hinges (4Holes) (7) to Panel (L) & (M). Use M3.5x14mm screws (2) to secure the metal hinges with the panels.
Installer les charnières métalliques (4 trous) (7) sur les panneaux (L) & (M). Utiliser des vis M3.5x14mm (2) pour fixer les charnières métalliques sur les panneaux.

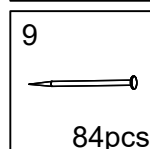
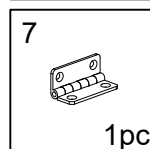
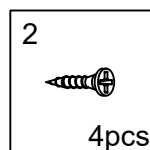

Step 14

Étape 14

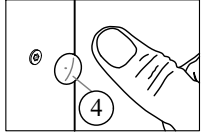

* Cover all the screw (3) 's head with the pvc cap provided by pushing the cover's stem onto the hole of screw head.

* Couvrez toutes les têtes de vis (3) avec le capuchon en pvc fourni en poussant la tige du capuchon sur le trou de la tête de vis.

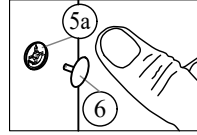

* Cover all the mini fix (nuts) (5a) 's head with the pvc cap provided by pushing the cover's stem onto the hole mini fix (nuts).

* Recouvrir toutes les têtes des mini-fixes (écrous) (5a) avec le bouchon en pvc fourni en poussant la tige du bouchon sur le trou des mini-fixes (écrous).

Complete Compléter

