

10 YEAR MANUFACTURER'S LIMITED WARRANTY

All parts of this Elements Of Design faucet are warranted to the original retail purchaser to be free from defects in material and workmanship for a period of ten(10) years from the date of purchase as shown on the purchaser's receipt. This warranty is limited to defective parts only, labor charges and/or damage resulting from improper installation, repair or replacements, as well as incidental and consequential damages connected therewith are excluded.

Any damage to this faucet as a result of misuse, abuse, neglect, accident for improper installation or any use not consistent with the instructions furnished by Elements of Design, will void this warranty. Replacement parts can be obtained from your local dealer.

CAUTION!!!

1. Water lines must be completely flushed before use, to avoid bris & clogs in your water system leading to malfunction and reduction of water flow.
2. Warranty to be void if water lines are not flushed before use of new faucet.
3. Use of abrasives of any strength may damage the finish of your faucet and void this warranty.

CODE APPROVAL: LA#M-000018

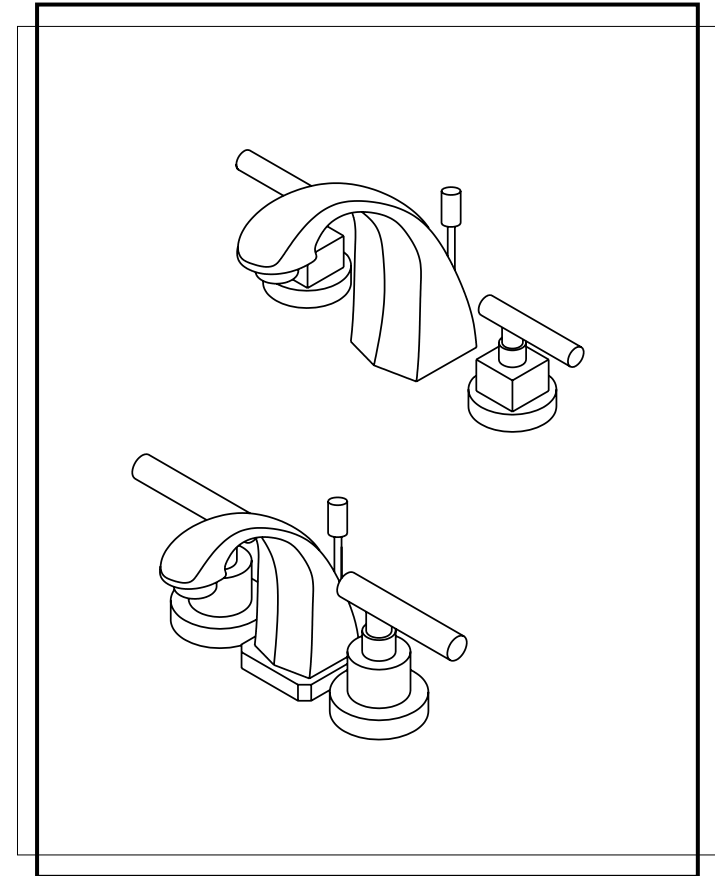

Elements
Of Design

T 909.465.6687 F 909.548.6843 1877.FAUCET.1
www.eodfaucet.com
email: support@eodfaucet.com

INSTALLATION SHEET

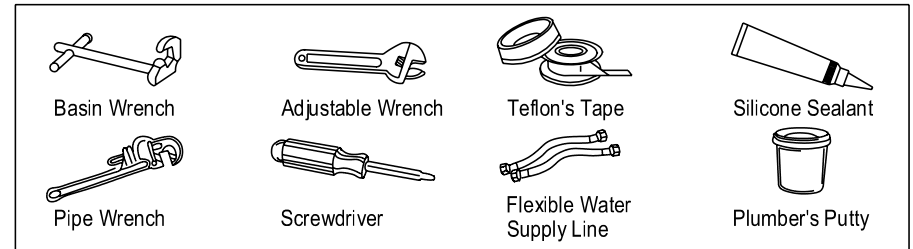

NOTE: 1. FLUSH LINE BEFORE FAUCET INSTALLATION TO REMOVE DEBRIS IN LINES.
2. NO PLUMBER'S PUTTY ON ANY FINISH TO CORRODE FINISH OF FAUCET SURFACE.

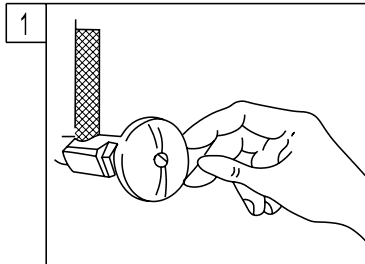

1. Shut off hot and cold water supply under sink. Plug sink drain with cloth to avoid losing small parts. Remove old faucet.

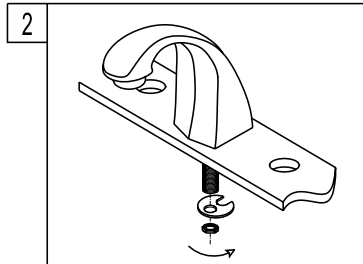

2. Install new faucet spout through the center hole of sink. Place mounting washer on spout shank and attach with spout shank locknut.

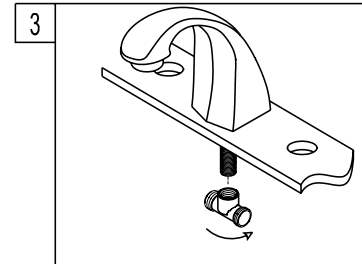

3. Attach Spout Tee on the spout shank.

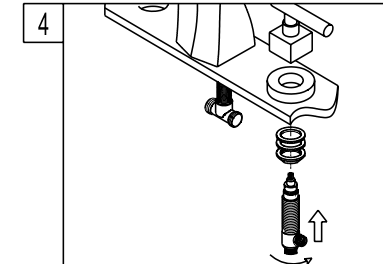

4. Hold the handles in proper position. Make sure that the top of the faucet handles is 5/8" above the top of the sink. Mount the metal washer and locknut from underneath the sink. Then reposition escutcheons as necessary to a desired height.

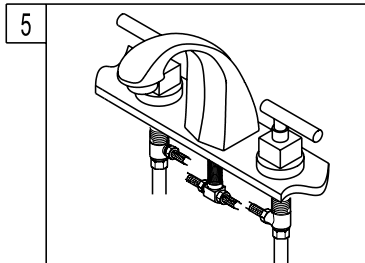

5. Connect the flexible tubes from the supply shank side port to the Spout Tee. Also reattach the supply lines, turn on the water supply, and check for leaks.

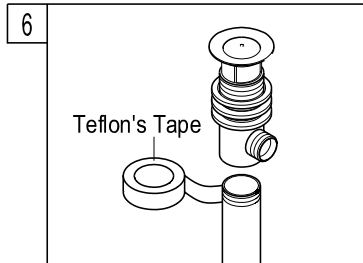

6. Thread mounting nut and bottom gasket onto drain body. Wrap top threaded end of the drain body with plumbers' tape.

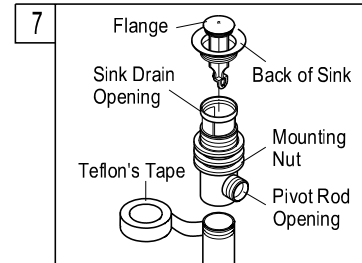

7. Install drain body up through the drain opening and reattach the flange onto drain body, holding the drain body in position with pivot rod opening facing the back of sink. Tighten the mounting nut by hand.

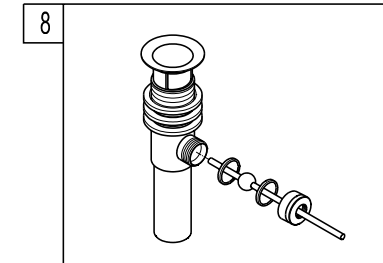

8. Place pivot rod into pivot rod opening. Slide pivot nut over pivot rod and thread it on the drain body. Tighten firmly.

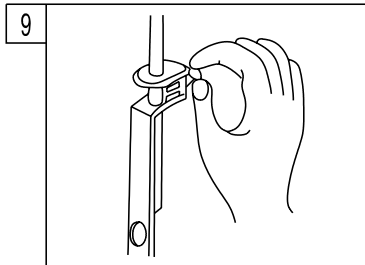

9. With lift rod in position on the faucet, insert lift rod through lift rod strap and secure with the clevis screw.

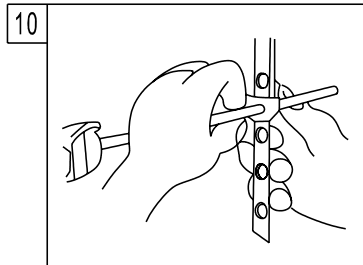

10. Guide the pivot rod through one of the holes on the lift rod strap and secure it with the spring clip. Then adjust the height of the lift rod by resetting the clevis screw.

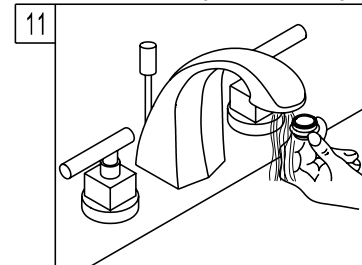

11. Remove the aerator before turning on your new faucet for the first time. Allow both hot and cold water to run for one minute. Replace aerator.