

# sku:SD-24002-BG/24002-DG

## Steel Wicker Chair Set



### Thank you for choosing us!

Our goal is to provide high quality outdoor furniture with outstanding customer service-all at an affordable price.

Please let us know how we are doing!

### Problems?

(Missing pieces, wrong pieces...)

We will fix it immediately. Send us an email at

**[aftersaledirect@gmail.com](mailto:aftersaledirect@gmail.com)**.











### Happy?

Please leave us a review!

You can make others happy too!

# Care & Maintenance

## Caution: You must read this before you proceed

- ❌  ● Not for commercial use. For residential use only.
- ❌  ● Prolonged exposure to rain may cause rusting which can stain floors.
- ❌  ● Do not put hot items directly on furniture surface.
- ❌  ● Do not clean furniture with harsh cleansers or polish.
- ✓  ● To obtain the longest lifespan of your outdoor products, minimizing exposure to direct sunlight is recommended.
- ❌  ● Children should not climb or jump on the furniture.
- ❌  ● Do not write on furniture without a padded barrier to protect the surface.
- ✓  ● To obtain the longest lifespan of your outdoor products, avoid extended and lengthy exposure to rain, snow, and direct sunshine. Whenever possible cover the product and /or place under patio or awnings.
- ❌  ● Do not place the product in stone areas or areas that absorb too much sunlight.
- ❌  ● Stains may be removed with mild soap solution and damp cloth.
- ✓  ● Keep away from sources of ignition.
- ✓  ● High-pressure water guns must not be used for cleaning. Dust and pick-up spills using a clean, non-colored, lint-free cloth.





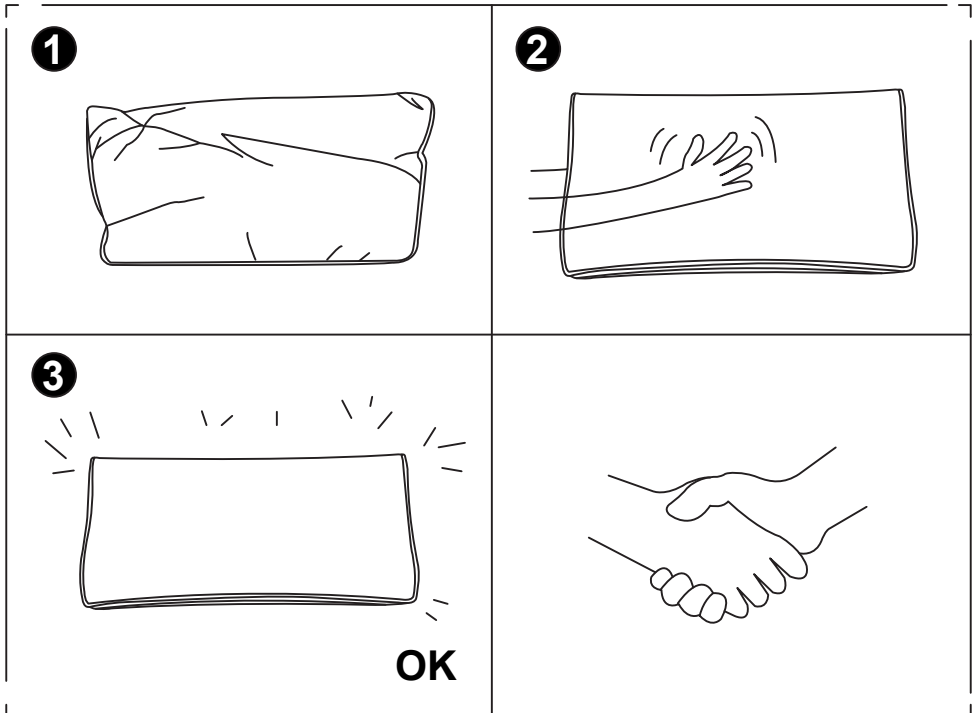

Tip: We recommend flattening the boxes to use as a protective work surface, or setting up your new furniture on a soft floor like a carpet.

# Tips for Cushions

In order to compress the package, we put the cushions in the gap of some parts. So there may be crinkle on the fabric. Don't worry. Just flap every corner of the cushion evenly and it will get back into its original shape soon.

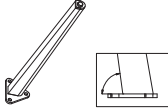
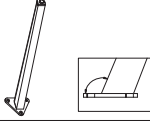

## COMPONENT LIST - CHAIR × 2

Item no.	Reference Image	Description	Qty.
A		Chair Seat	1
B		Front Leg	2
C		Back Leg	2
D		Seat Cushion	1
E		M6X15 Head Cap Screw	12
F		Washer	12
G		Allen Key	1

**NOTE:**

Do NOT tighten any screws fully first until you have tightened all the screws.

This may cause the frame to warp.

If there is still wobbles or screw holes cannot be aligned, loosen the screws and tighten sequentially.

If the Chair is not stable it could lead to damage to the product.

# 01

(E)



(F)



M6\*15 Screw x12

Washer x12

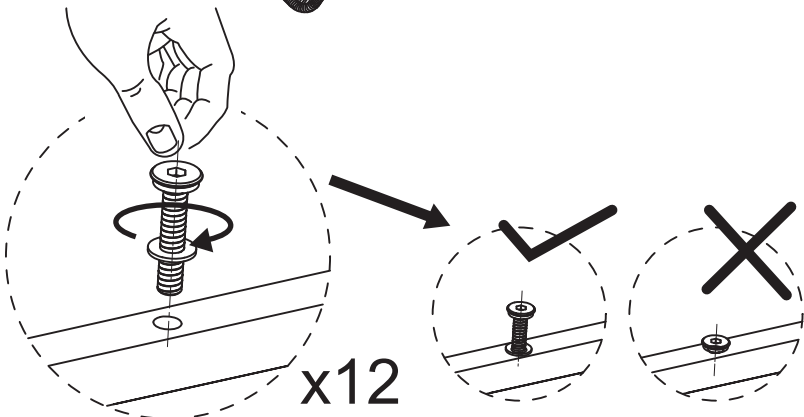
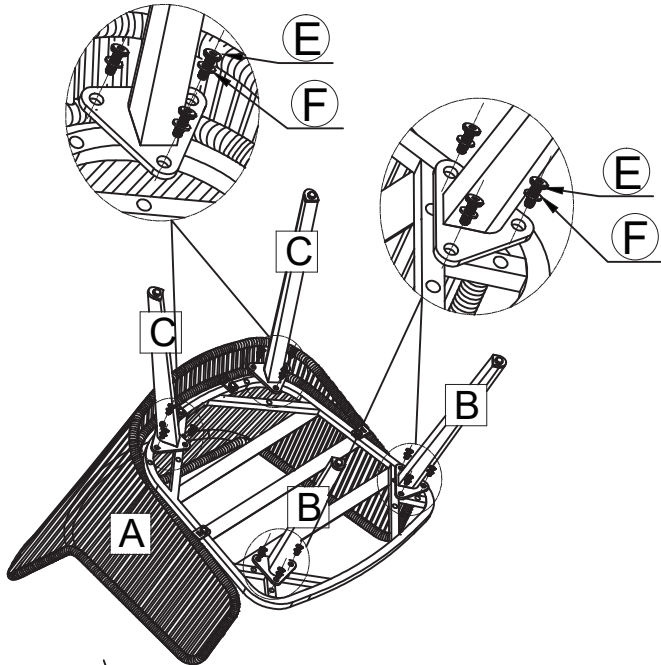

**NOTE:DO NOT TIGHTEN THE SCREWS COMPLETELY.**

# 02 Tighten all 12 Screws into place with Allen Key (G).

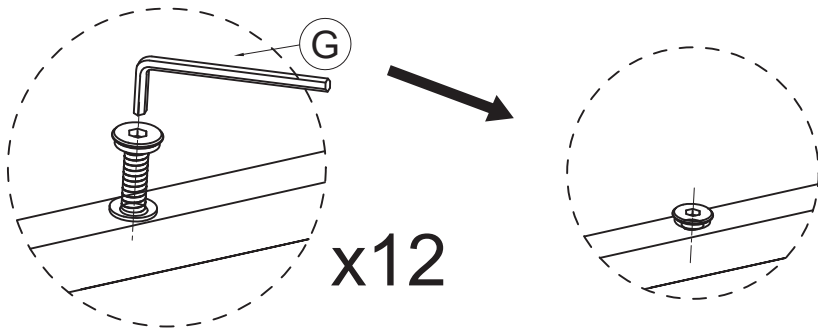
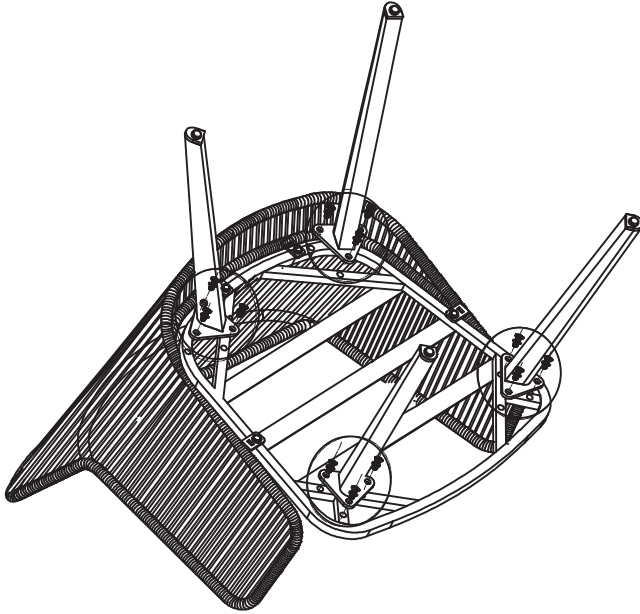

**NOTE:**IF ANY SCREW HOLES CANNOT BE ALIGNED,  
LOOSEN ALL THE SCREWS AND GO BACK STEP  
1 AND RESTART ASSEMBLY.

**03** Place the chair on a level surface, and put the Seat Cushion (D) on the chair. Now your chair is ready for use.

