



**LEDsone**  
110V-240V~50Hz

RoHS



# LEDSONE'S WALL LAMP FITTING INSTRUCTION

LEDSONE UK LTD

Customer Service Tel No : 00442476154687

CV2 2NW

**⚠ Please read the instructions care fully before start insatllation**

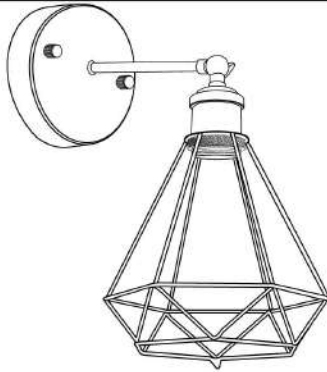

Suggested tools for assembling



Wrench



Screw driver



Drill



Measurement tape

Before start assembling

- Safety first
- Turn off power
- Use proper tools
- Check for damage
- Follow the instructions
- Keep the product dry
- Don't work alone
- Seek professional help

**WARNING !!!**

Before proceeding make sure the electricity is switchd off at the main supply

Basic installation Instructions

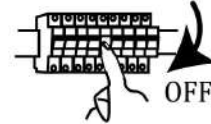

Make sure to turn off the power source to the circuit you will be working on. Locate the circuit breaker or fusebox and turn off the switch or remove the fuse that controls the circuit.

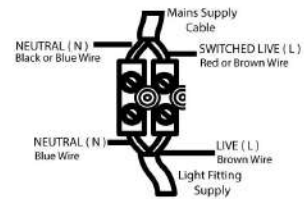

Use wire connectors for safty connection. Wire connectors are a common and important electromechanical component. Connectors can join to create electrical circuits and paths for a current.

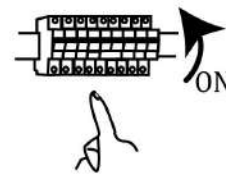

Dont forget to restore the power supply after the full installation

Continue to next page for the product Assembling →

**WARNING !!!**

Before proceeding make sure the electricity is switchd off at the main supply

## ACCESSORIES FIGURE



— x1Pcs

**A**



— x2Pcs

**G**



— x2Pcs

**B**



— x1Pcs

**H**



— x2Pcs

**C**



— x2Pcs

**D**



— x2Pcs

**E**



— x2Pcs

**F**

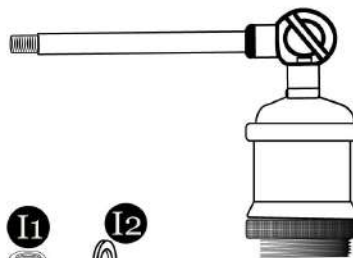

**I1**

**I2**

— x1Pcs

**I**

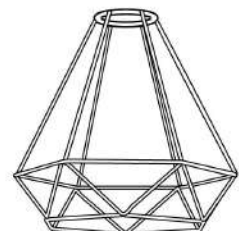

— x1Pcs

**J**

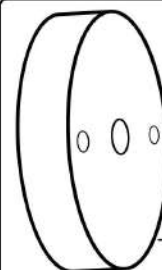

— x1Pcs

**K**



**LEDSONE**  
110V-240V~50Hz

RoHS



# LEDSONE'S WALL LAMP FITTING INSTRUCTION

