

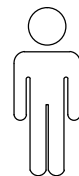

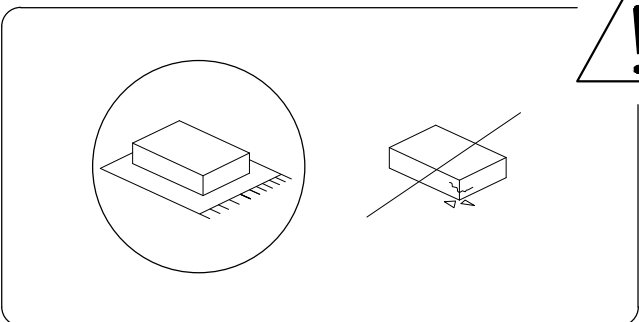

60'

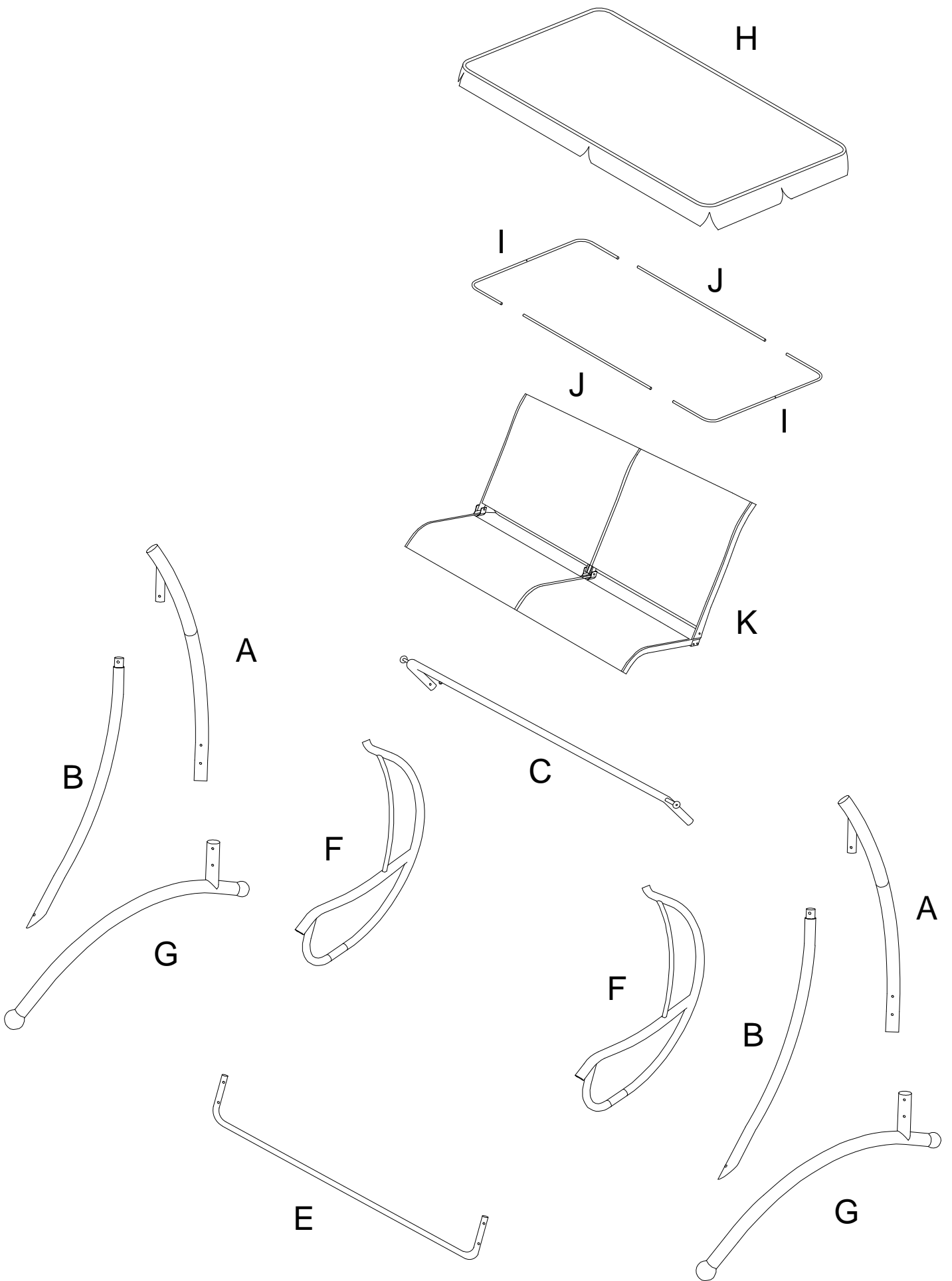

2

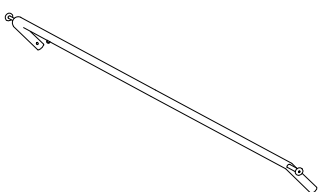
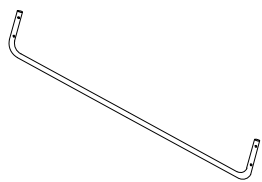
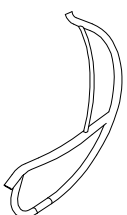
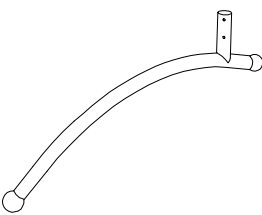
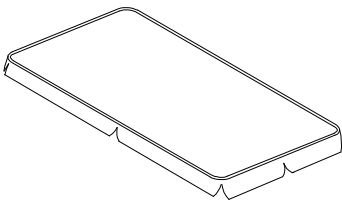
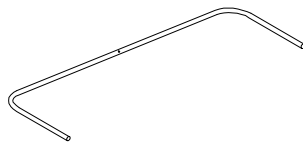
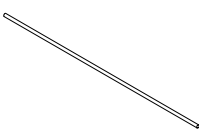
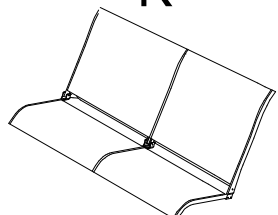

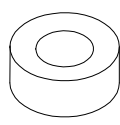
<p>A</p>  <p>x 2</p>	<p>B</p>  <p>x 2</p>	<p>C</p>  <p>x 1</p>
<p>E</p>  <p>x 1</p>	<p>F</p>  <p>x 2</p>	<p>G</p>  <p>x 2</p>
<p>H</p>  <p>x 1</p>	<p>I</p>  <p>x 2</p>	<p>J</p>  <p>x 2</p>
<p>K</p>  <p>x 1</p>	<p>M</p>  <p>x 2</p>	<p>O</p>  <p>x 4</p>

P2

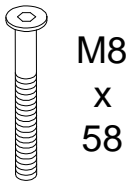

x 6

P3

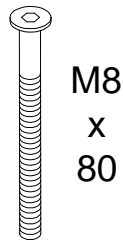

x 6

P4

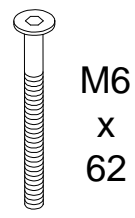

x 4

T

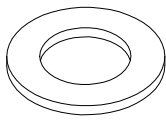

x 4

T1

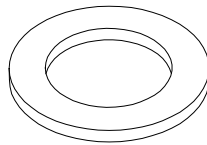

x 10

S1

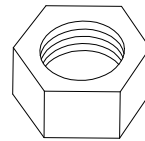

x 10

N1

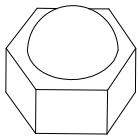

x 10

S

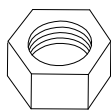

x 4

N

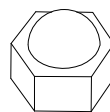

x 4

V



x 1

X

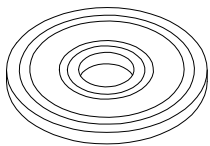

x 2

Y

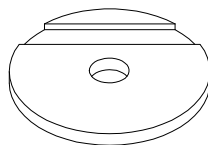

x 4

Z1







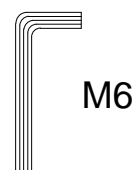



x 1

Z2



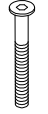
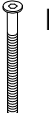



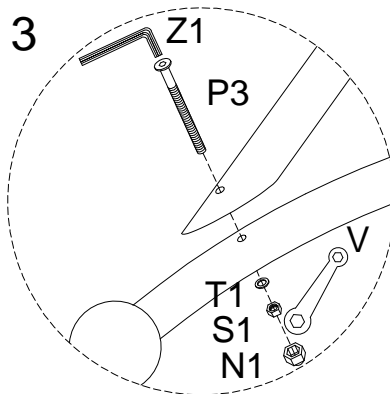
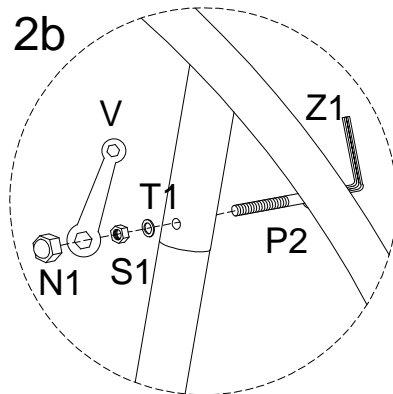
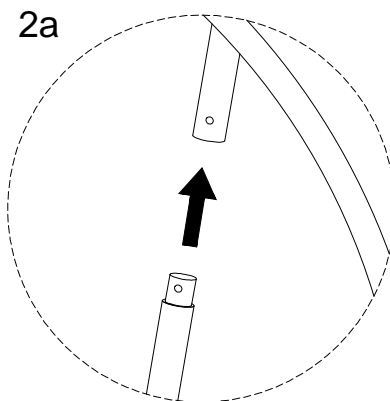
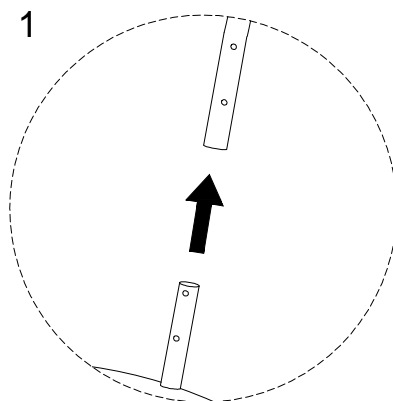
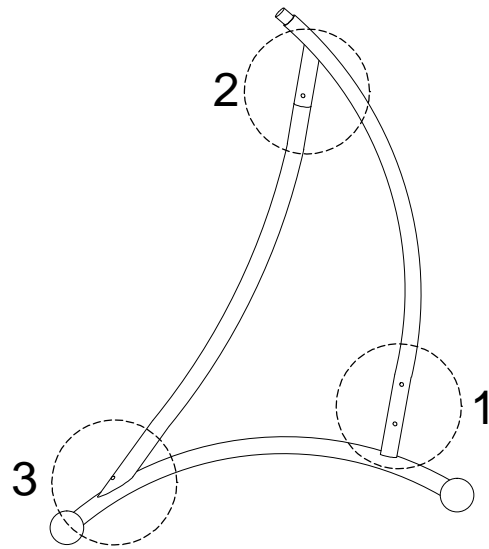

x 1

1 x 2

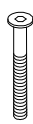
<b>A</b>  x 1	<b>B</b>  x 1	<b>G</b>  x 1	<b>T1</b>  x 2	<b>P2</b>  M8 x 58 x 1
<b>P3</b>  M8 x 80 x 1	<b>S1</b>  x 2	<b>N1</b>  x 2	<b>V</b>  x 1	<b>Z1</b>  M8 x 1







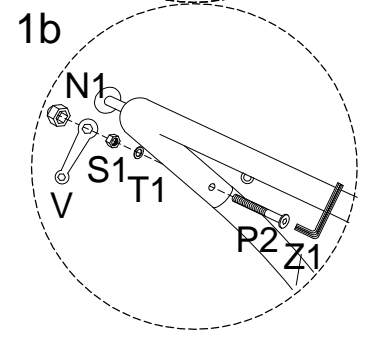
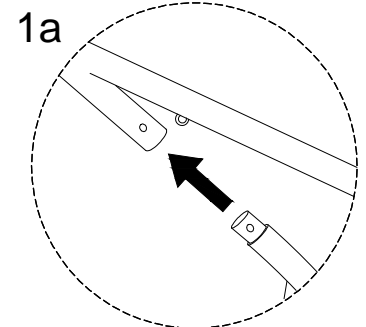
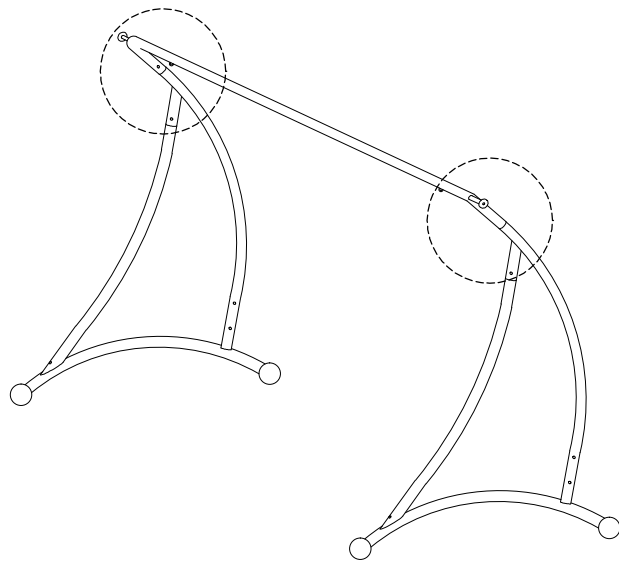

2

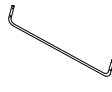
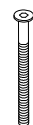
<b>C</b>  x 1	<b>P2</b>  M8 x 58 x 2	<b>T1</b>  x 2	<b>S1</b>  x 2	<b>N1</b>  x 2	<b>V</b>  x 1	<b>Z1</b>  M8 x 1
--	---	---	---	--	--	---







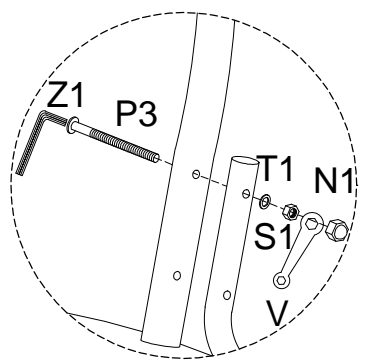
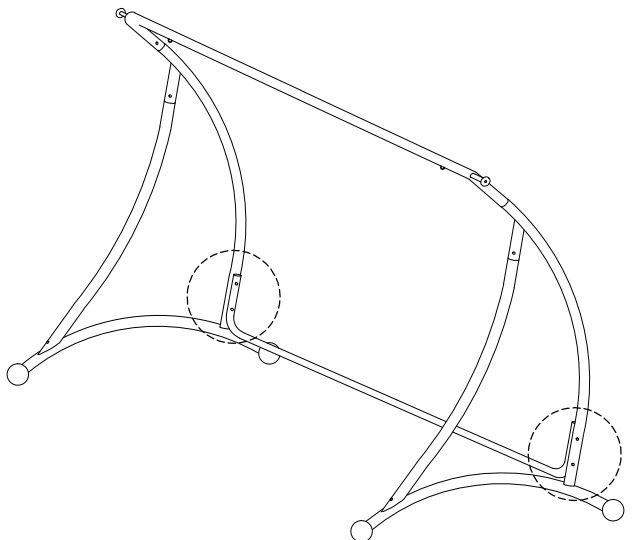

3

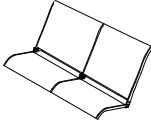
<b>E</b>  x 1	<b>P3</b>  M8 x 80 x 4	<b>T1</b>  x 4	<b>S1</b>  x 4	<b>N1</b>  x 4	<b>V</b>  x 1	<b>Z1</b>  M8 x 1
--	---	---	---	--	--	---

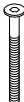

4

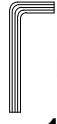
<p>F</p>  <p>x 2</p>	<p>K</p>  <p>x 1</p>	<p>O</p>  <p>x 4</p>	<p>P4</p>  <p>M6 x 62 x 4</p>	
<p>T</p>  <p>x 4</p>	<p>P</p>  <p>x 4</p>	<p>N</p>  <p>x 4</p>	<p>V</p>  <p>x 1</p>	<p>Z2</p>  <p>M6 x 1</p>

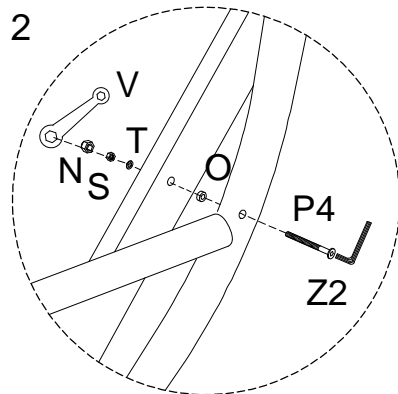
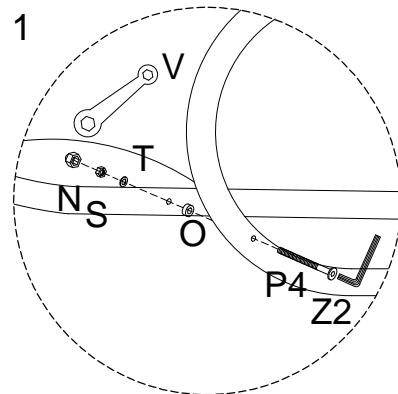
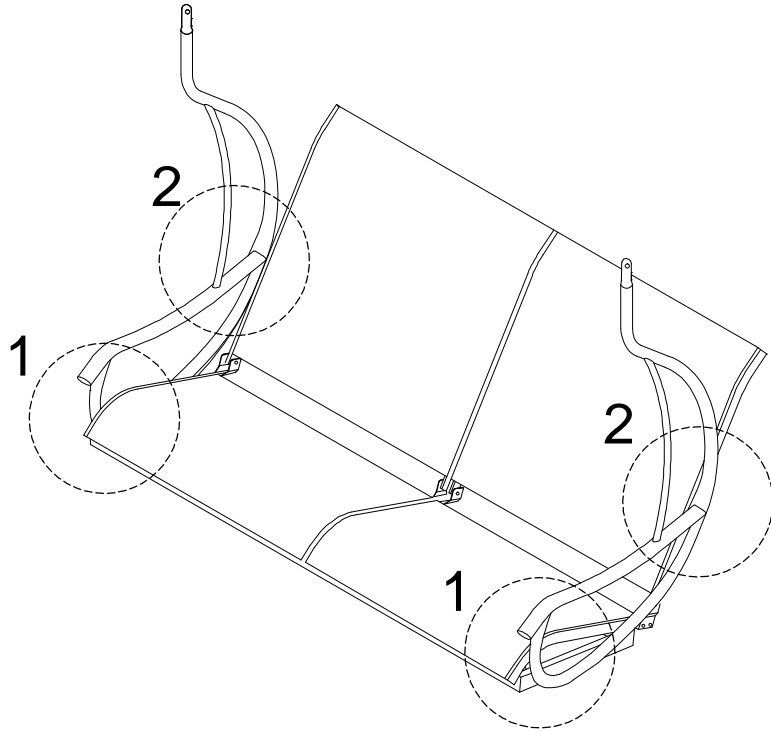

5

M  
  
x 2

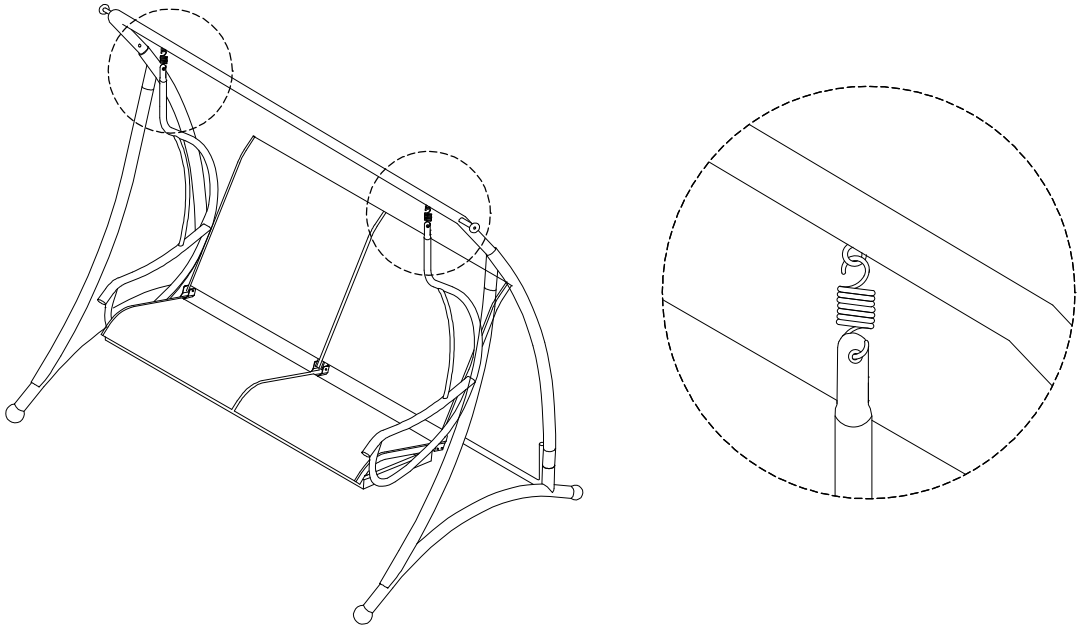

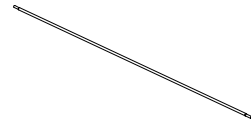

6

I  
  
x 2

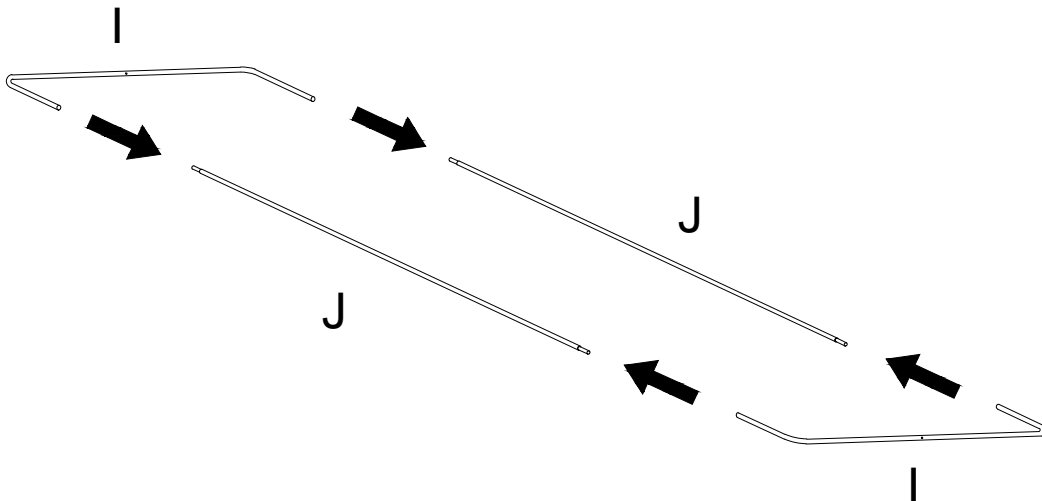
J  
  
x 2

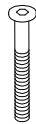
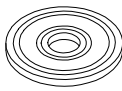
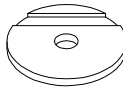

7

<p>P2 M8 x 58 x 2</p> 	<p>X x 2</p> 	<p>Y x 4</p> 	<p>Z1 M8 x 1</p> 
---	--	---	--

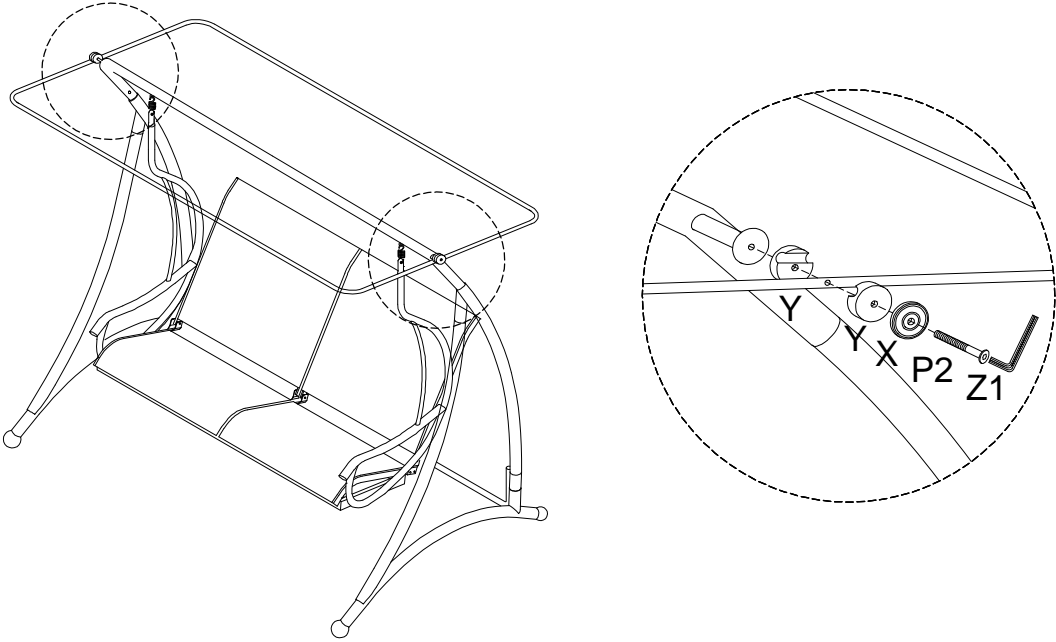

8

H  
x 1

