

# ZEAFIVE<sup>®</sup>

## ASSEMBLY INSTRUCTIONS

### BRI-48"



PRODUCT  
INSTRUCTION  
VIDEO

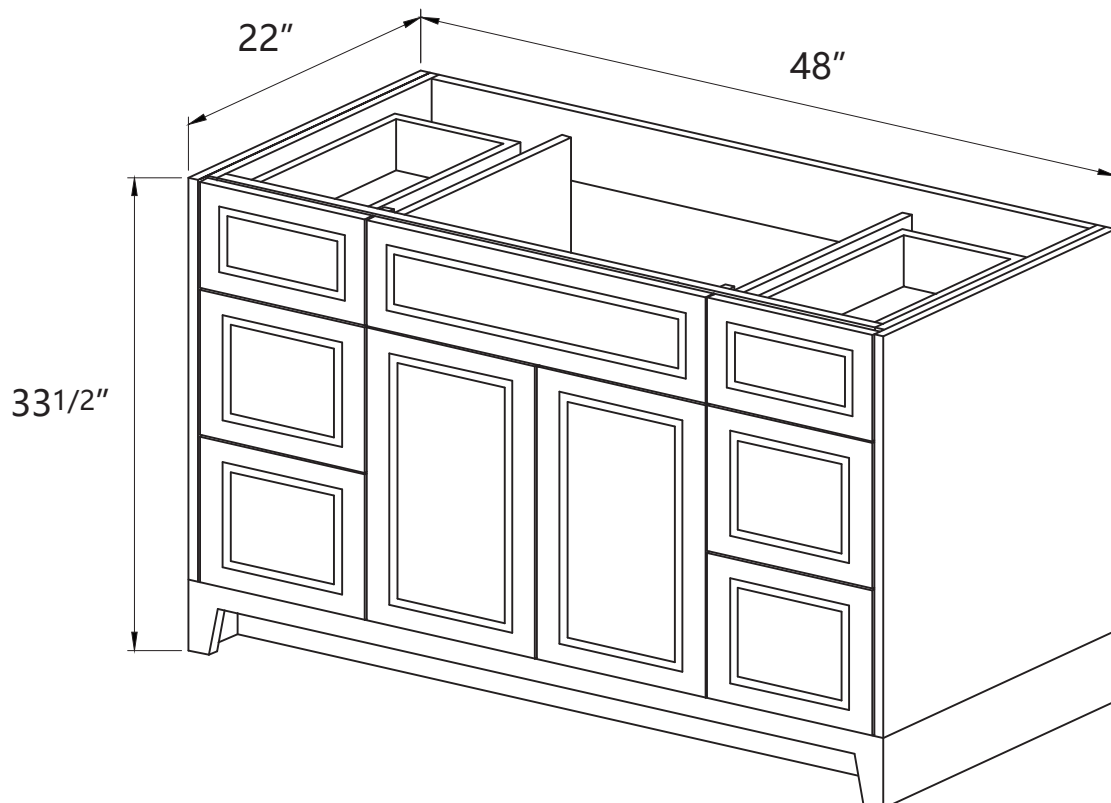



NOTE: Any size of the vanity's installation steps are the same.

## INSTALLATION STEPS

**Install the handle:** loosen the screw of the handle which pre-installed inside the vanity, and take it out, according to the same location to install the handle on the opposite side of the cabinet surface.

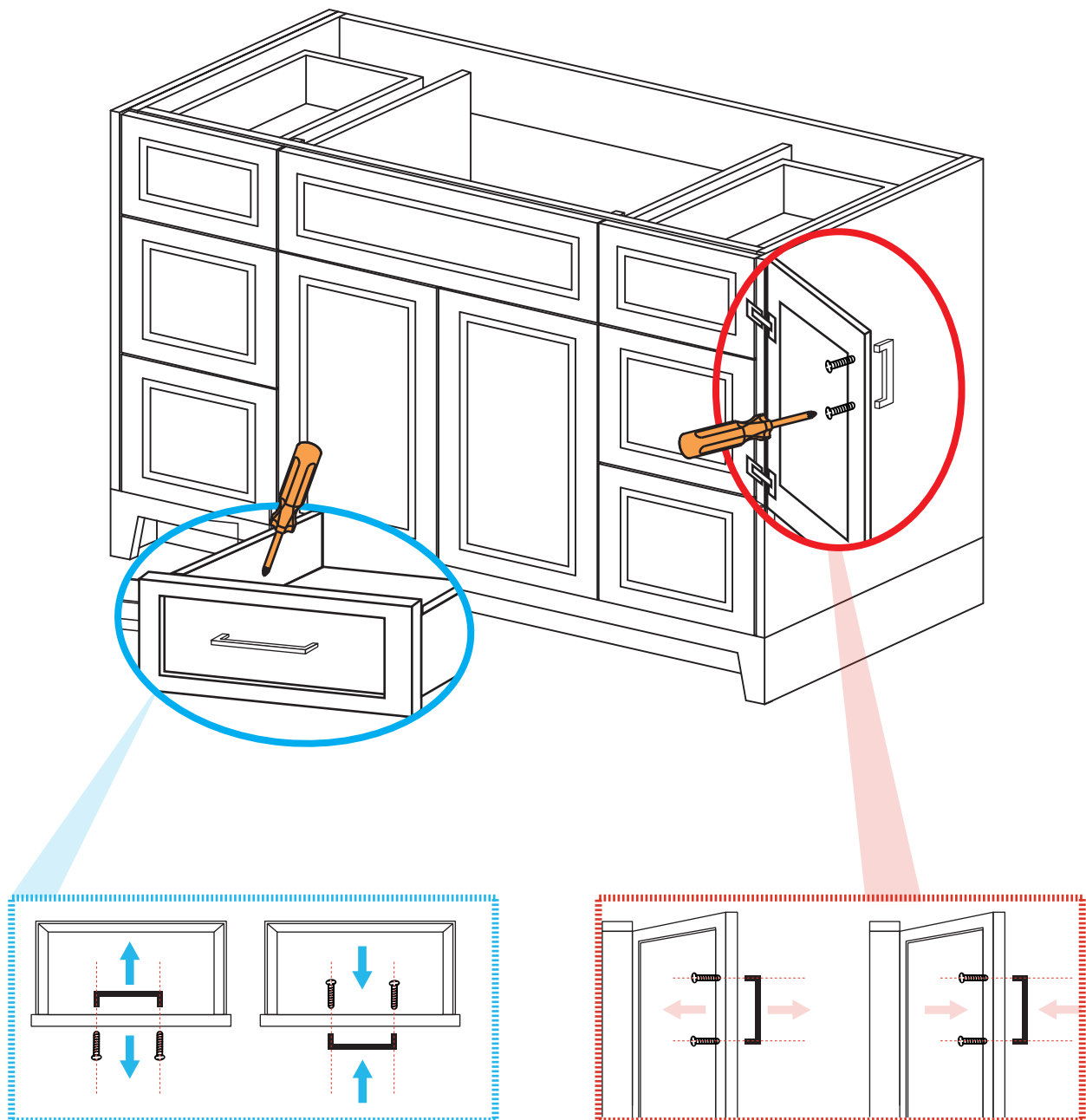

## CARE & MAINTAINCE

**1.Regular Cleaning:** Wipe down the vanity regularly with a soft cloth and a mild, non-abrasive cleaner to remove dust, dirt, and grime. Avoid using harsh chemicals or abrasive cleaners that could damage the finish.

**2.Prevent Water Damage:** Keep the vanity dry by wiping up any spills or splashes immediately. Avoid leaving wet items on the vanity surface for extended periods.

**3.Use Coasters and Trivets:** Place coasters under toiletries, cosmetics, and hot hair styling tools to prevent damage from heat or moisture.

**4.Check for Leaks:** Regularly inspect the plumbing connections under the vanity for any leaks. Address any leaks promptly to prevent water damage to the vanity.

**5.Avoid Harsh Cleaners:** Refrain from using abrasive cleaners, ammonia-based products, or harsh chemicals on the vanity surface, as they can damage the finish.

**6.Protect the Surface:** Consider using a protective sealer or wax specially formulated for your vanity material to maintain its finish and protect it from water damage.

**7.Adjust Hinges and Hardware:** Periodically check and tighten loose hinges, knobs, or drawer pulls to ensure smooth operation and prevent damage.

**8.Remove Stains Promptly:** If you notice any stains on the vanity surface, try to clean them promptly using a gentle cleanser recommended for your vanity material.

**By following these maintenance tips, you can help preserve the aesthetics and functionality of your bathroom vanity for years to come.**

# HOME SERVICES

---



INSTALLATION VIDEO

**Missing Part or Defective?**

Please Contact the Customer Service Team

 [service@bestgosupplychaininc.com](mailto:service@bestgosupplychaininc.com)