

Operating Instructions

Caution : You must read this before you proceed



SAFETY WARNING

Never adjust chaise lounge or recliner backrest while seated.

Always make sure the backrest is flat before moving the chaise lounge.





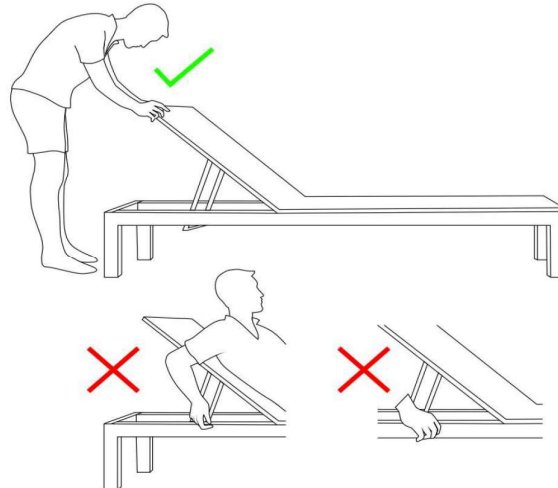





Keep all limbs clear from under the backrest when it is in a raised position.

Serious finger, hand, or other bodily injuries may result from adjusting the chaise lounge backrest position while seated.



The examples pictured above are non exhaustive and are for your reference only

Care & Maintenance

- ⊘  • Not for commercial use. For residential use only.
- ⊘  • Prolonged exposure to rain may cause rusting which can stain floors.
- ⊘  • Do not put hot items directly on furniture surface.
- ⊘  • Do not clean furniture with harsh cleansers or polish.
- ✓  • To obtain the longest lifespan of your outdoor products, minimizing exposure to direct sunlight is recommended.
- ⊘  • Children should not climb or jump on the furniture.
- ⊘  • Do not write on furniture without a padded barrier to protect the surface.
- ✓  • To obtain the longest lifespan of your outdoor products, avoid extended and lengthy exposure to rain, snow, and direct sunshine. Whenever possible cover the product and/or place under patio or awnings.
- ⊘  • Stains may be removed with mild soap solution and damp cloth.
- ✓  • Keep away from sources of ignition.
- ✓  • Dust and pick-up spills using a clean, non-colored, lint-free cloth.



Assembly Instructions

CAUTION: You must read this Assembly Instructions before you proceed

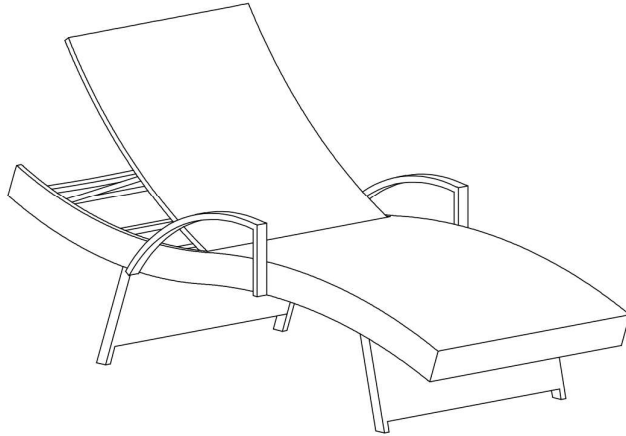

LOUNGE

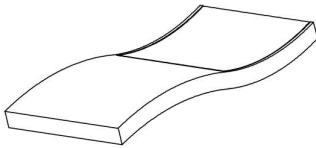

Part List

Label	Picture	Description	QTY
A		Seat Panel	1
B		Left Arm	1
C		Right Arm	1

Hardware

Label	Picture	Description	QTY
1		Bolt (M6x40mm)	7
2		Washer (M6x15mm)	7
3		Allen Wrench	1

Assembly Preparation

Before Beginning Assembly:

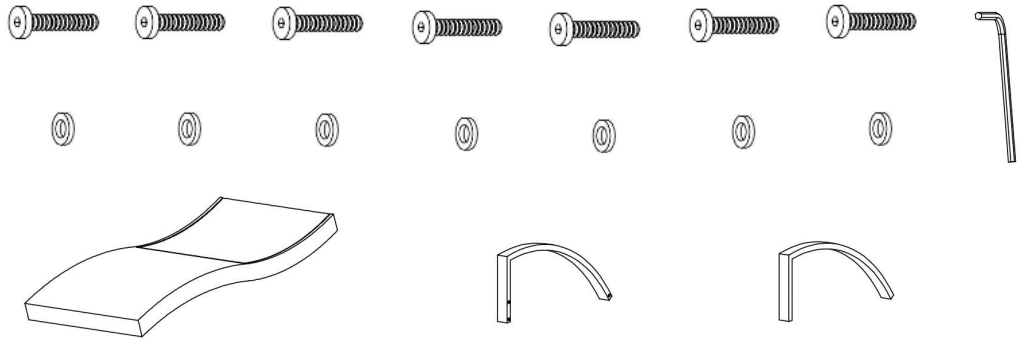

- Read instructions, cover to cover-



- Have 2 adults on hand for assembly-



- Do not assemble on flooring or carpet-



- Assemble on a clean non-marring surface (packing foam)-



- Save all packaging until finished-

Assembly Steps

Overview

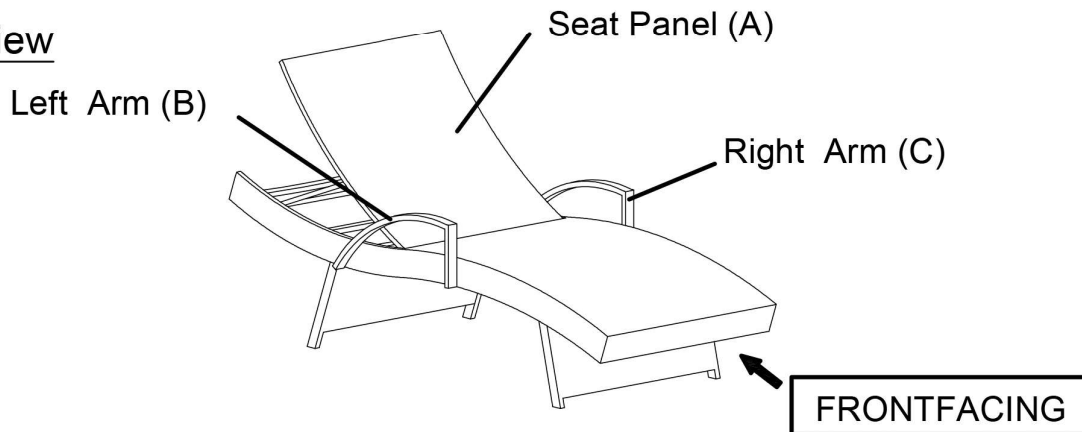

This Lounge has multiple parts and may require up to 15 minutes to assemble. To give you an overview of the Lounge parts, the above picture is to help you put the various parts into perspective. Please read through the instructions below to familiarise yourself with the parts and steps before assembly.

Step 1

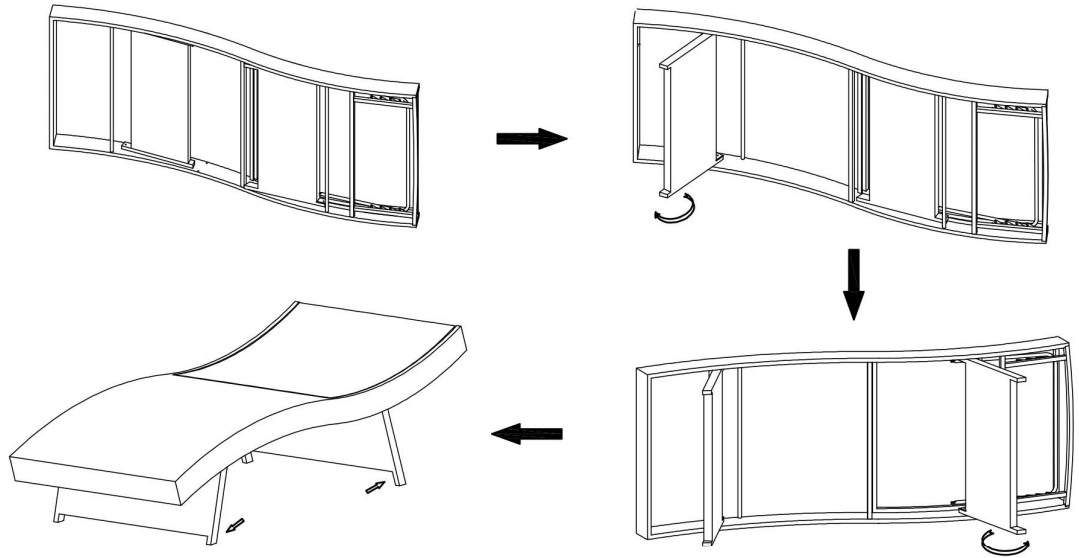

Put the one side of the Lounge as pictured on a clean, non-marring surface. To open, first open the leg under the seat to the maximum angle, and then open the other leg which under back also to the maximum angle, by hand. Then, carefully put the Lounge right side up, lay on the ground. Use a hand to rock the lounge to make sure all the legs have been opened totally.

Step 2

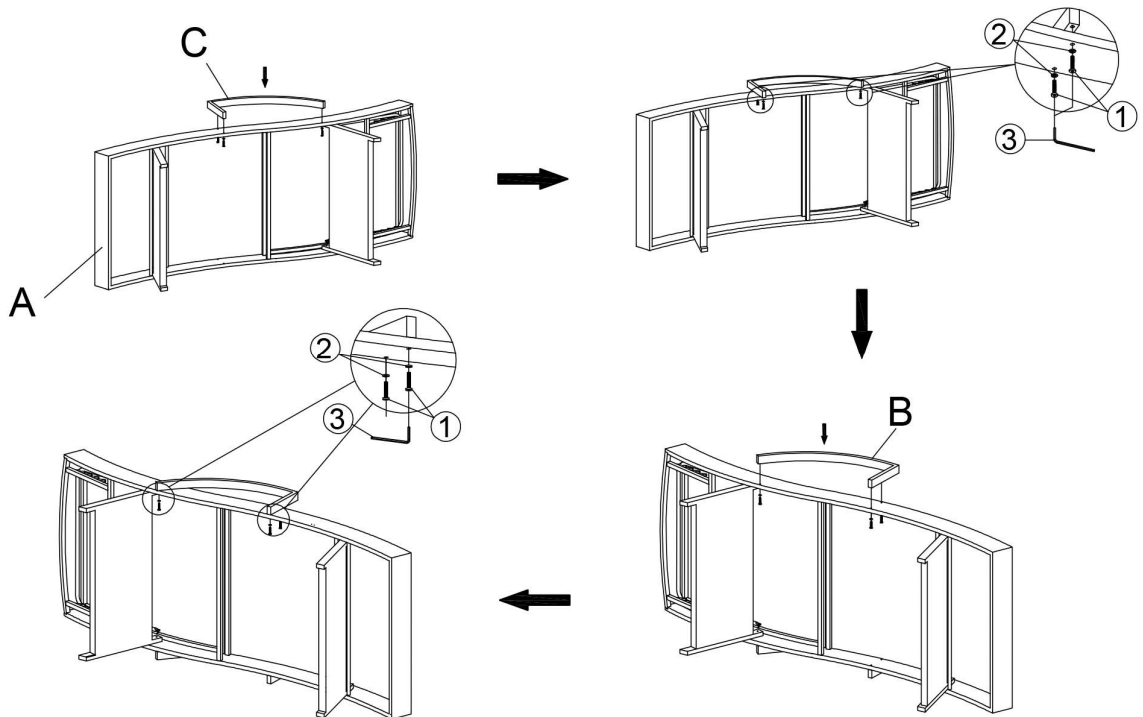

Open the back, Attach Right Arm (C) and Left Arm (B) to the Seat Panel (A) using Bolt (1) and Washer (2), with Allen Wrench (3).

Step 3

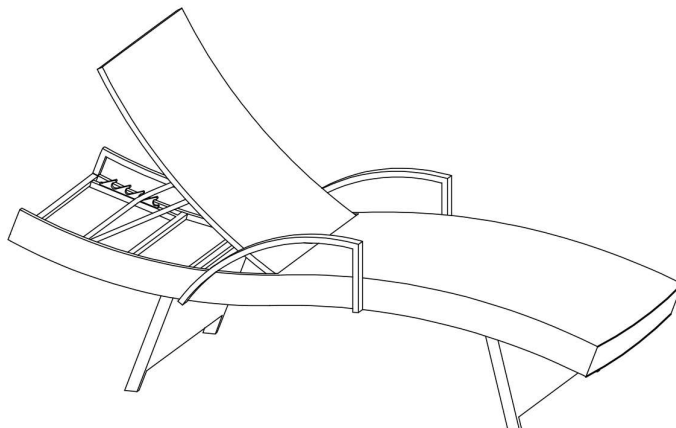

Adjust the adjustable tube of the back, to find the suitable height. Your Lounge is ready for use.
This Lounge can only be used on a flat, level surface.

Step 4



Your Lounge is ready for use.

Questions & Answers about Proposition 65

- What is Proposition 65?

Proposition 65 requires businesses to provide warnings to Californians about significant exposures to chemicals that cause cancer, birth defects or other reproductive harm. These chemicals can be in the products that Californians purchase, in their homes or workplaces, or that are released into the environment. By requiring that this information be provided, Proposition 65 enables Californians to make informed decisions about their exposures to these chemicals.

Proposition 65 also prohibits California businesses from knowingly discharging significant amounts of listed chemicals into sources of drinking water.

Proposition 65 requires California to publish a list of chemicals known to cause cancer, birth defects or other reproductive harm. This list, which must be updated at least once a year, has grown to include approximately 900 chemicals since it was first published in 1987.

- What types of chemicals are on the Proposition 65 list?

The list contains a wide range of naturally occurring and synthetic chemicals that include additives or ingredients in pesticides, common household products, food, drugs, dyes, or solvents. Listed chemicals may also be used in manufacturing and construction, or they may be byproducts of chemical processes, such as motor vehicle exhaust.

- What does a warning mean?

If a warning is placed on a product label or posted or distributed at a workplace, a business, or in rental housing, the business issuing the warning is aware or believes that it is exposing individuals to one or more listed chemicals.

By law, a warning must be given for listed chemicals unless the exposure is low enough to pose no significant risk of cancer or is significantly below levels observed to cause birth defects or other reproductive harm.

- Where can I get more information on Proposition 65?

If you have specific questions on the administration or implementation of Proposition 65, you can contact OEHHA's Proposition 65 program at P65.Questions@oehha.ca.gov, or by phone at (916) 445-6900.