

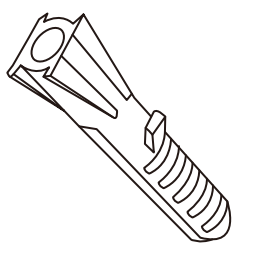

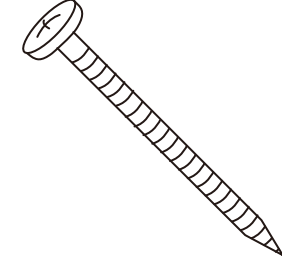

Check carefully after opening the box. Make sure there are no missing pieces and the shower doors do not have any cracks. During installation, please be careful with the corners of the glass doors. They are very fragile. After the shower doors are installed, the sliding doors should be parallel to each other to open and close smoothly, without gaps or water seepage, and the shower and the bottom basin should be sealed with silicone between them.

Parts list

 A×8 Internal accessories length: 29mm	 B-1×8 Internal accessories length: 52mm	 B-2×6 Internal accessories length: 15mm	 B-3×2 Internal accessories length: 13mm	 C×1 Internal accessories Nail bit	 D×1 Internal accessories length: 58mm	 E×4 Internal accessories length: 39mm
 F×4 Internal accessories length: 55mm	 G×8 Internal accessories Diameter: 12mm	 H×4 Internal accessories size: 100*33*17mm	 I×3 Internal accessories size: 60*50*22mm	 J×6 Internal accessories Diameter: 9mm	 K×8 Internal accessories Nail bit	 L×1 Internal accessories Frame Accessories
 M×2 Internal accessories Frame Accessories	 N×1 Internal accessories Frame Accessories	 O×2 Internal accessories Glass	 P×2 Internal accessories Handle			

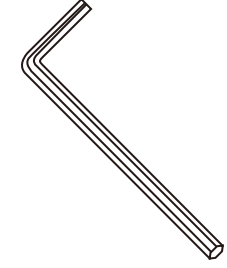
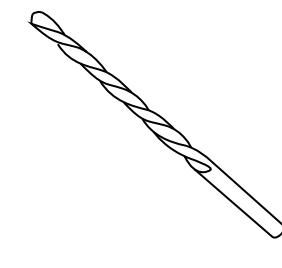
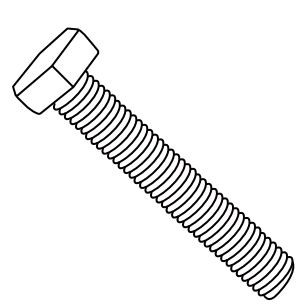
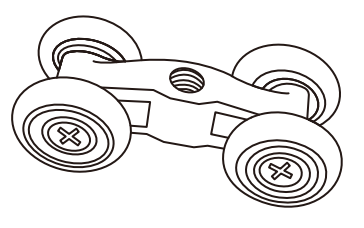
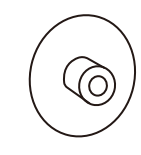
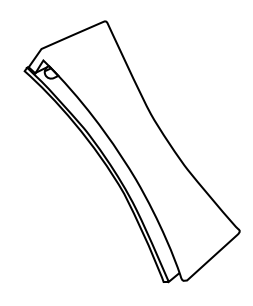
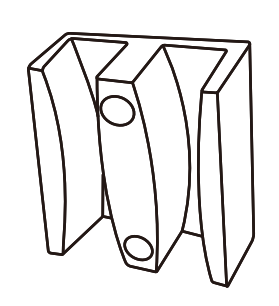
Tools Not Included

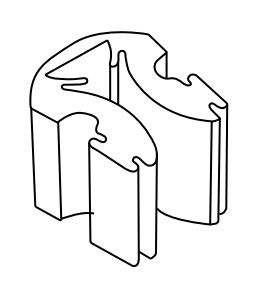
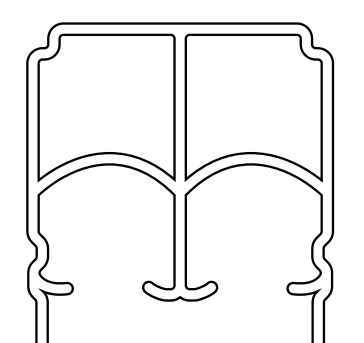
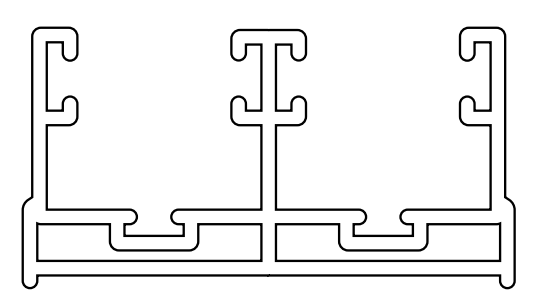
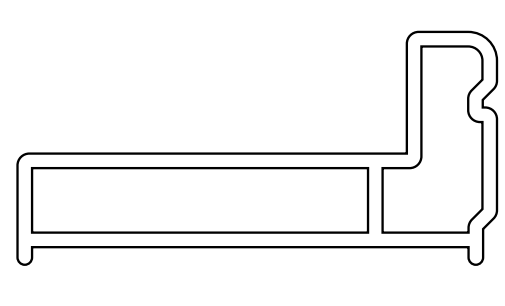
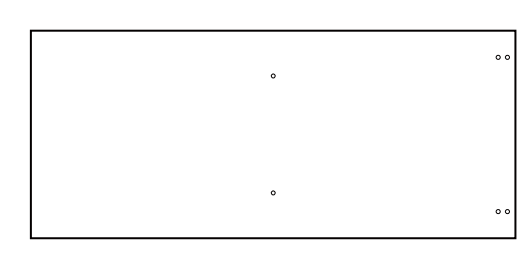
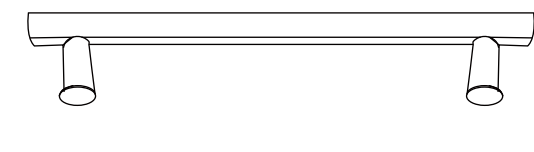
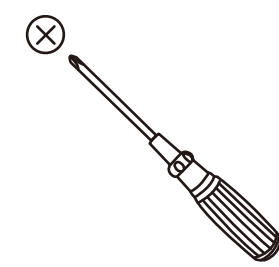
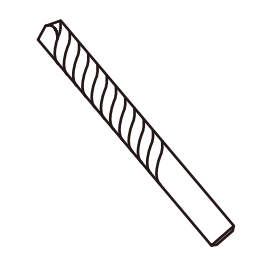
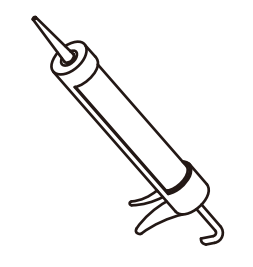
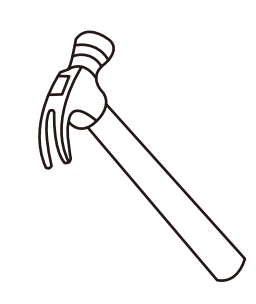
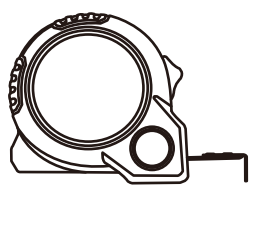
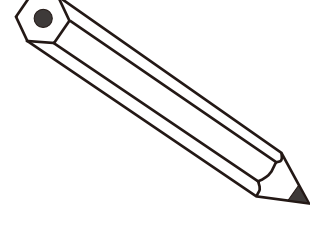
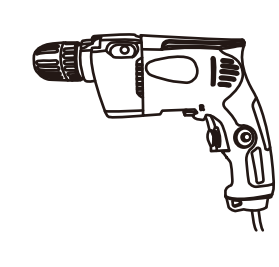
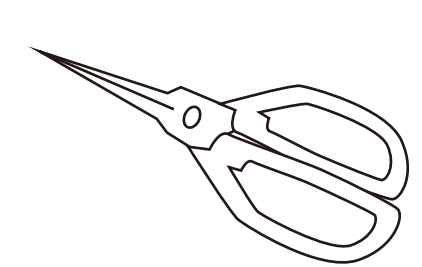
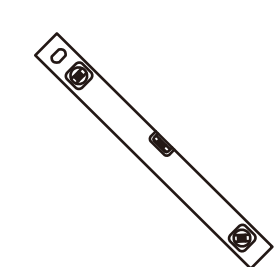
 Phillips screwdriver Tools needed	 Assorted Drill Bits Tools needed
 Glue gun Silicone Nail bit	 Adjustable Wrench Nail bit
 Internal accessories Tools needed	 Internal accessories Tools needed
 Percussion Drill Tools needed	 Internal accessories Tools needed
 Level Tools needed	

Package contents

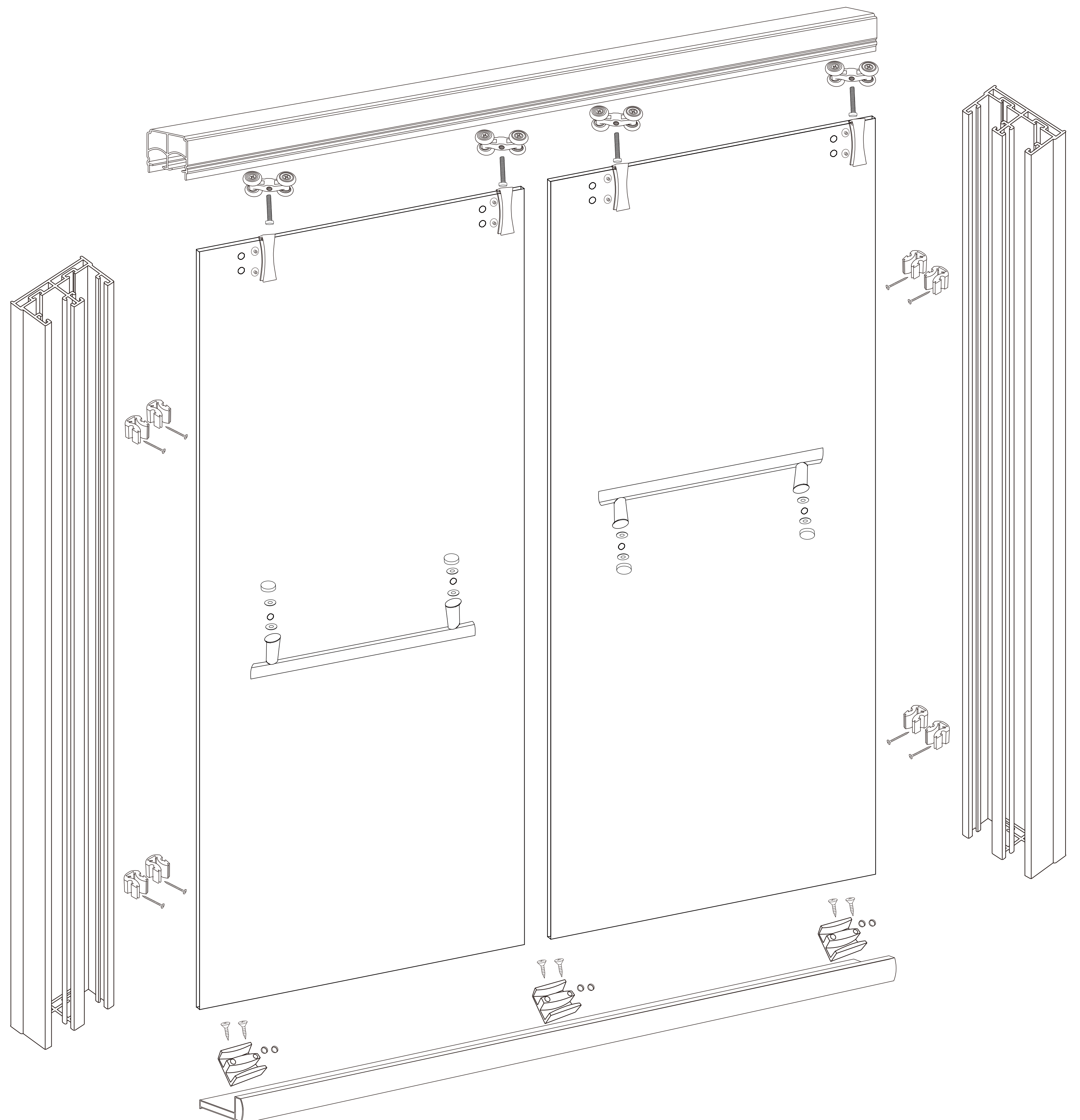

The following instructions will guide you through the installation of a sliding shower door.

*Glass doors can be installed on either side.
Frame parts will need to be flipped over to install the sliding door on the left or right side.

Step 01

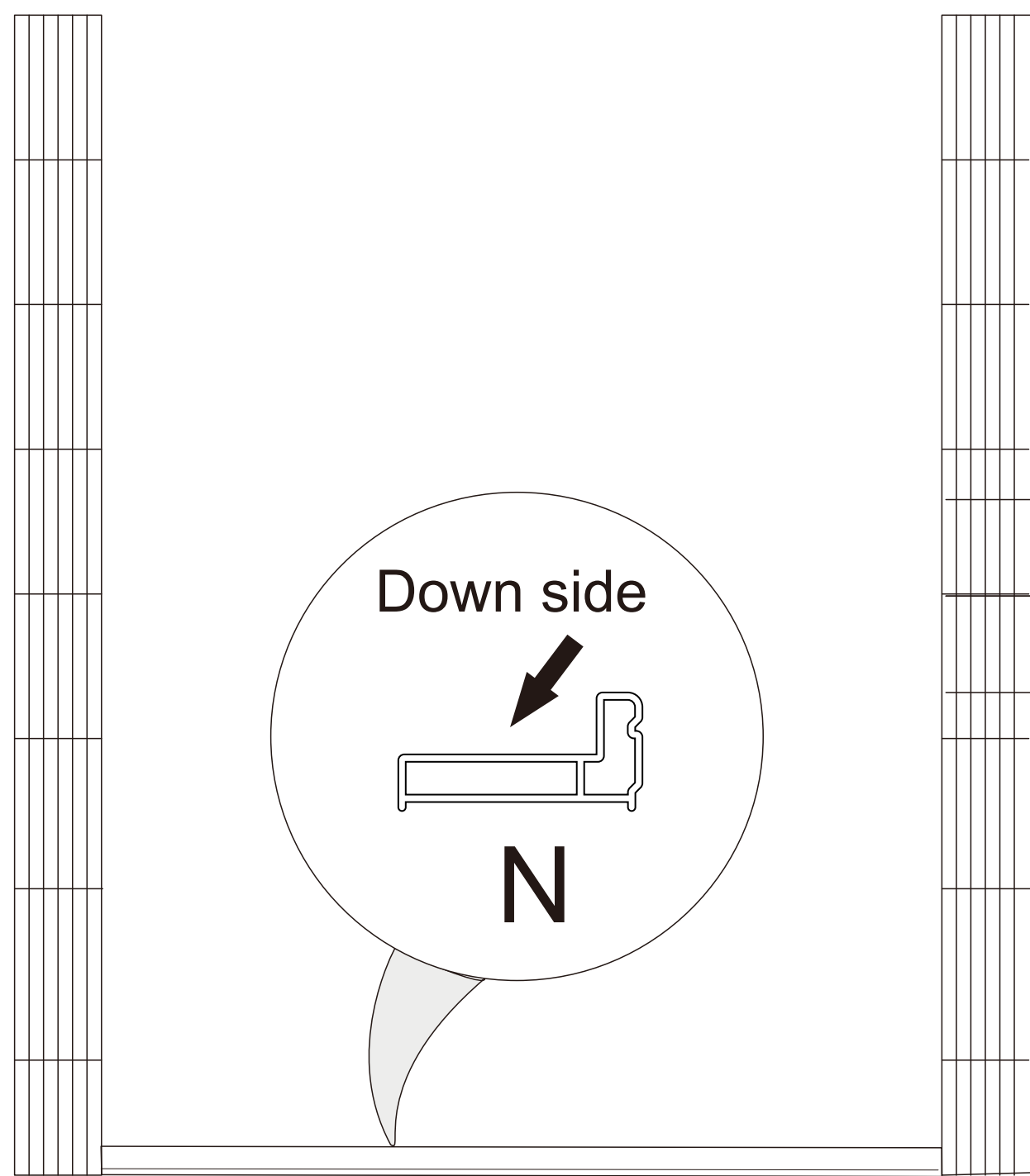

Choose a suitable location and place the N level on the ground

Step 02

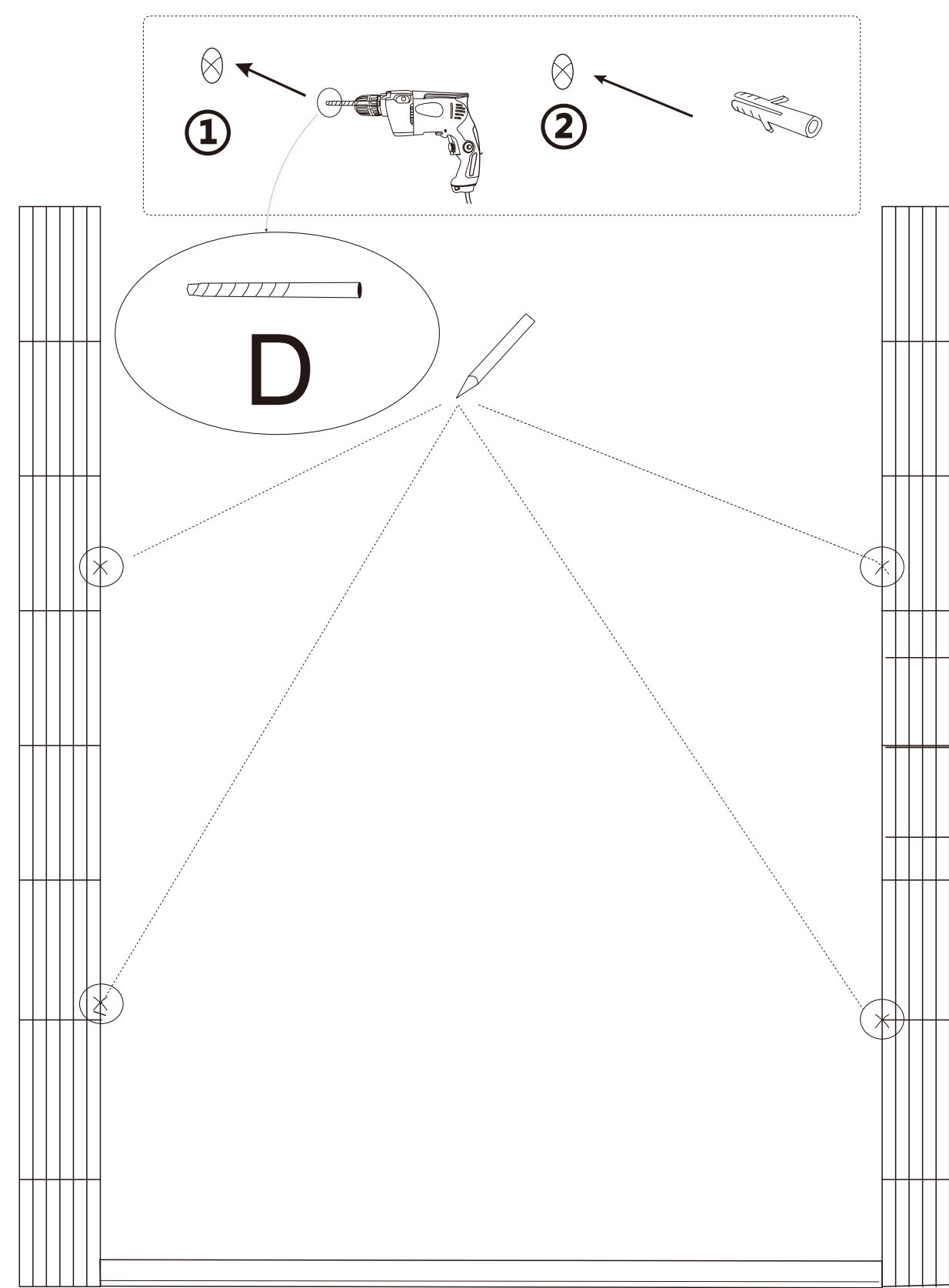

Place the frame M horizontally perpendicular to the floor on the wall and use the eight holes in the frame M to mark the punched places on the wall, then remove M and use a drill to punch holes at the marked places and put A

Step 03

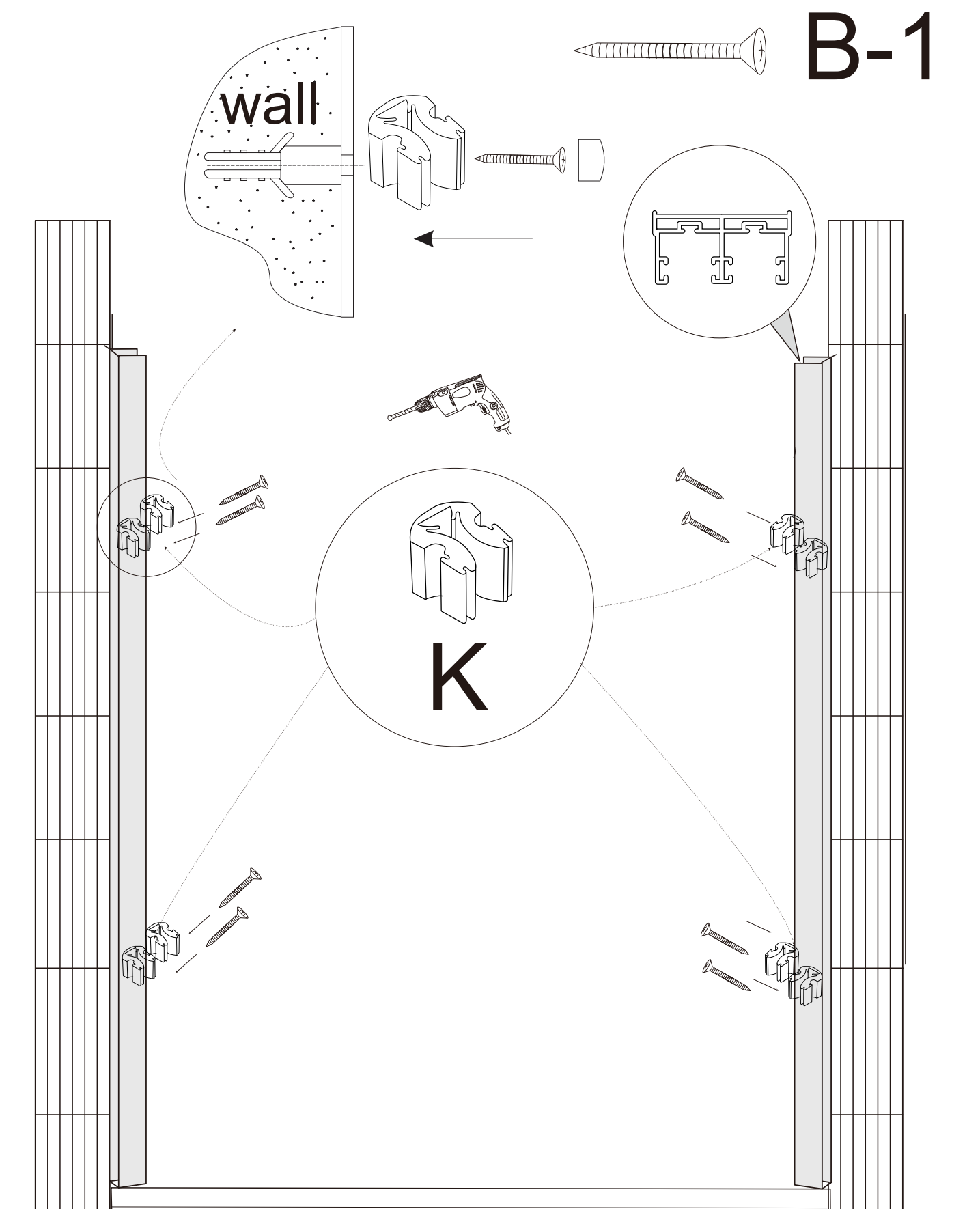

Change a cross bit on electric drill, Match holes on K with holes on wall (1*B-1 for each hole)(1*G for each hole from K)

Step 04

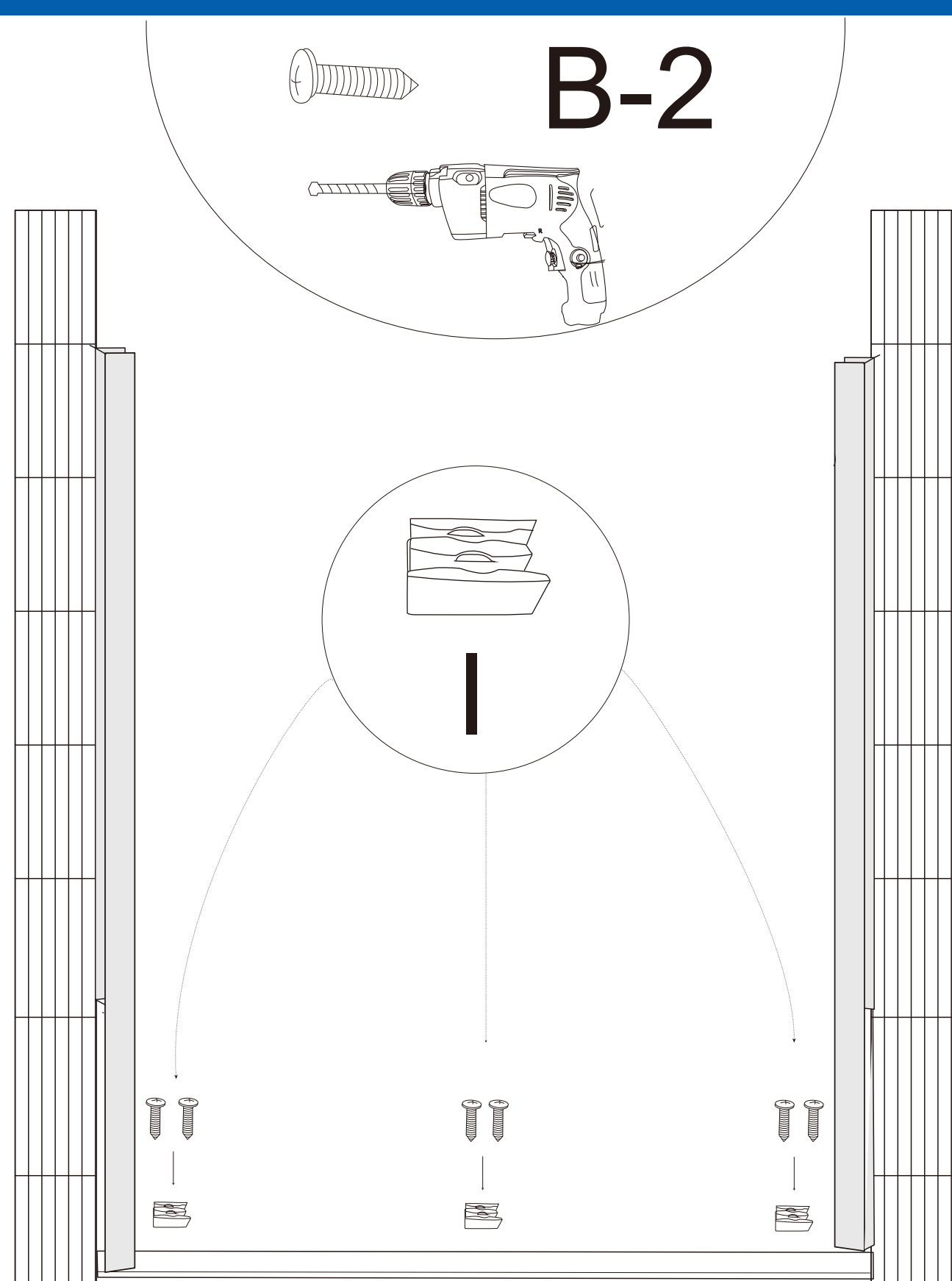

Put 3*I on exact places shown on picture Use B-2 to fix, 1*J for each hole.

Step 05

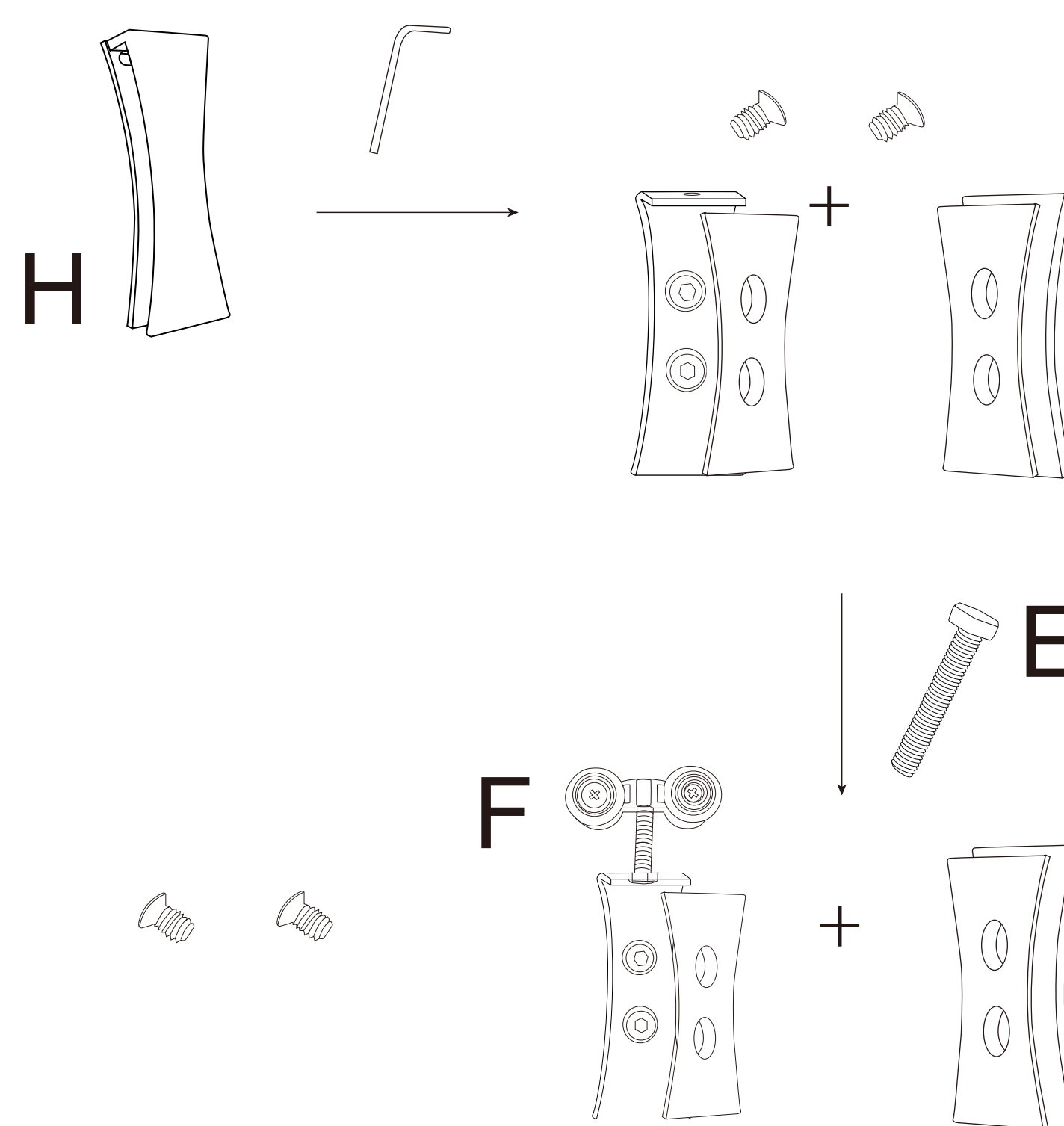

Here are 2 paths on up track, put 2 roller sets in each path, do not lock these 2 screws at the end of this step

Step 06

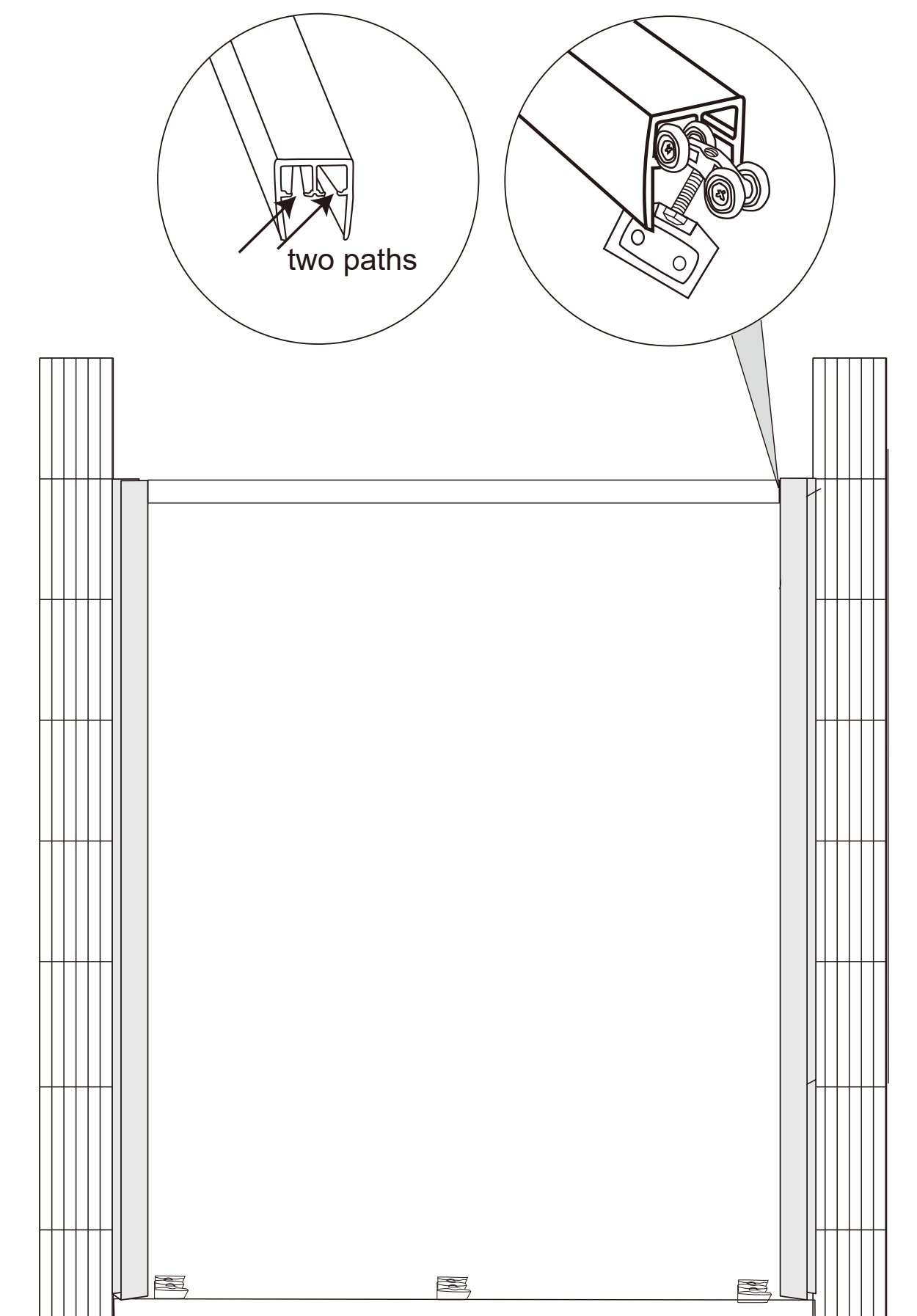

Put up track(with 4 rollers) on, use B-3 to fix it with 2 vertical frames if you feel not strong enough.

Step 07

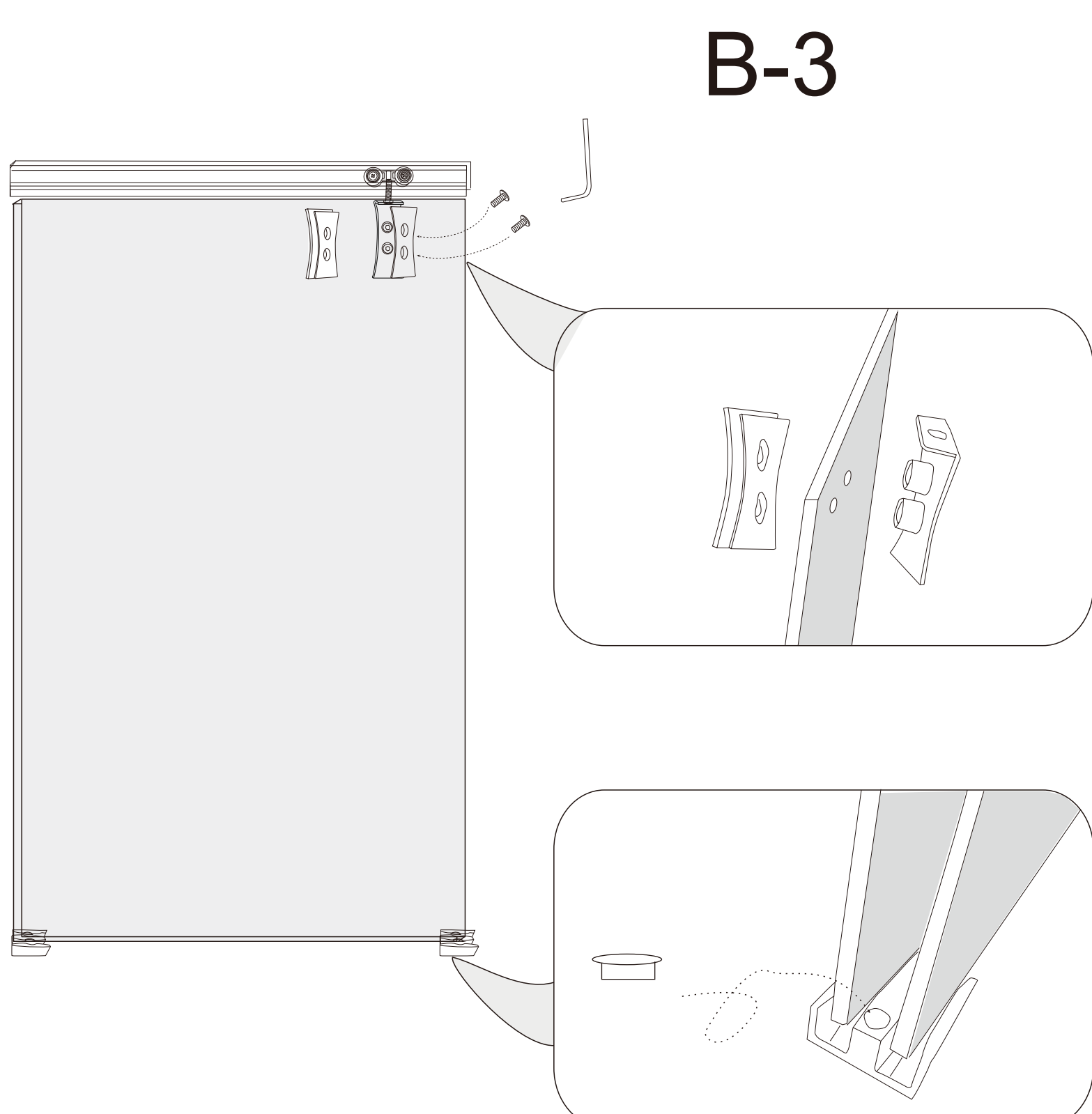

Ask someone to lift the glass for fixing it with hinges on rollers, leave a little space between glass and H

Step 08

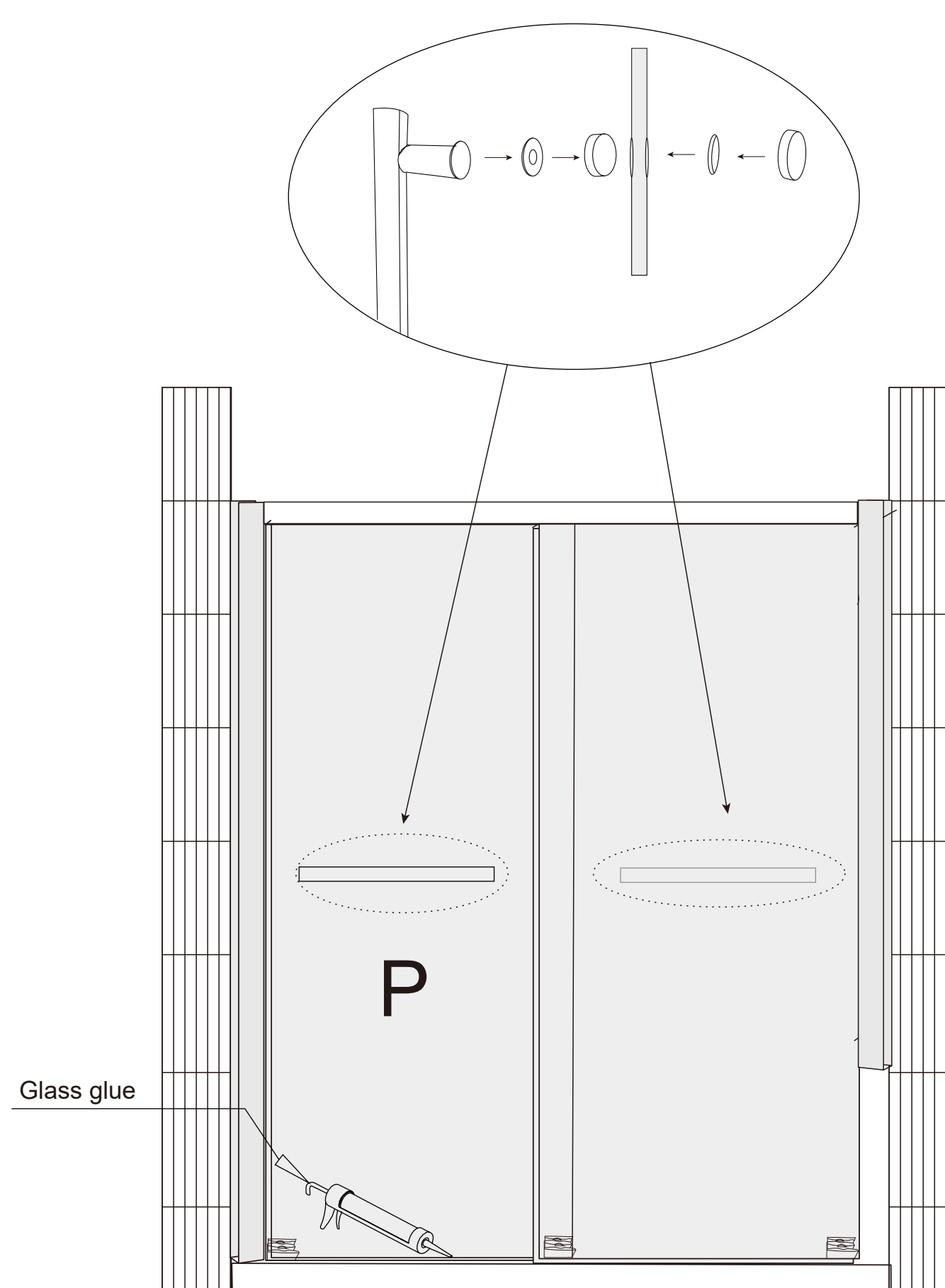

Make sure both sides are with rubber piece between glass and handle

Step 09

Remark

1. Cut up & down tracks to fit with your bathtub length.
2. Put rollers into up track first, and keep rollers inside, then deal with glass doors.
3. Before fixing glass doors with hinges on rollers, make sure the down side of glass is snapped into the track.
4. After installation of frame and glass, use glass glue on down side track.
5. ABOUT CLEANING
Glass: Use alcohol to wet a piece of cloth, then wipe the glass.
Down track: Usually use wet cloth to wipe the dust or water stains, oil stains require cleaner.