

Instruction Manual

2.7m Premium LED Round Parasol



CONTENTS

Safety and care advice	1
Components	2
Assembly instructions	3
Copyright	10

⚠ SAFETY AND CARE ADVICE ⚠

PLEASE READ THESE INSTRUCTIONS CAREFULLY AND KEEP FOR FUTURE REFERENCE

- **Warning:** This unit weighs approximately 6.5kgs. Please lift with care.
- Check you have all the components and tools listed on page 2.
- Remove all fittings from the plastic bags and separate them into their groups.
- Keep children and animals away from the work area, small parts could choke if swallowed.
- Make sure you have enough space to lay out the parts before starting.
- Do not stand or put weight on the product, this could cause damage.
- Assemble the item as close to its final position (in the same room) as possible.

- Assemble on a soft level surface to avoid damaging the unit or your floor (use opened out unit carton).



- We do not recommend the use of power drill/drivers for inserting screws, as this could damage the unit. Only use hand screwdrivers.
- Dispose of all packaging carefully and responsibly.

CARE AND MAINTENANCE

- Only clean using a damp cloth and mild detergent, do not use bleach or abrasive cleaners.
- From time to time check that there are no loose screws on this unit.
- This product should not be discarded with household waste. Take to your local authority waste disposal center.

Note: If required the next page can be cut out and used as reference throughout the assembly. Keep this page with these instructions for future reference.

- We strongly recommend that you store your parasol when not in use, especially during winter months.

We do not recommend leaving your parasol out in poor weather or unattended in furniture when a gust of wind could cause damage.

You should ensure your parasol is clean and dry to prevent any mould or mildew forming when folded and stored.

COMPONENTS

Ensure the following components are in the box before proceeding with assembly:



A x1



Umbrella Frame and Canopy

B x1



Lower Pole

C x1



Solar Panel

D x1



Raincover



ASSEMBLY INSTRUCTIONS

- Step 1** Locate the plug at the top of the umbrella. Carefully insert the plug into the socket located on the underside of the solar panel.

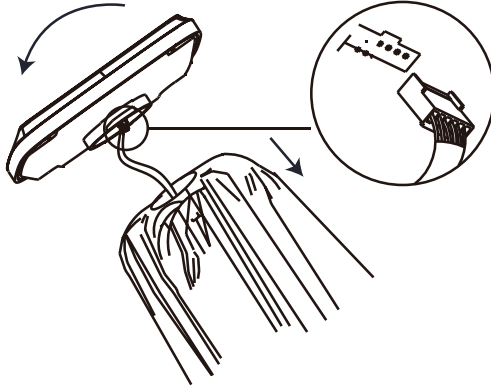

- Step 2** Place the solar panel on the top of the umbrella taking care to conceal the wires inside the gap at the top of the umbrella, then gently turn the solar panel in a clockwise direction to attach it to the umbrella. Take care not to over tighten as this may damage the umbrella and/or the solar panel. **Once the assembly is complete, remove the protective plastic film on the solar panel, this film is used to prevent damage during shipment.**

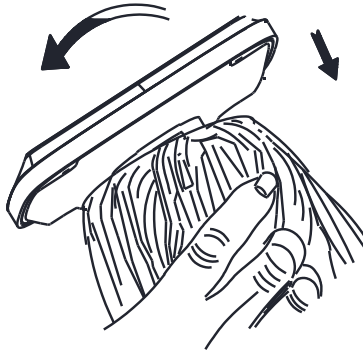

ASSEMBLY INSTRUCTIONS

- Step 3** To assemble the umbrella frame to the lower pole: Locate and press in the spring-button on the umbrella frame until it clips into the hole located on the lower pole.

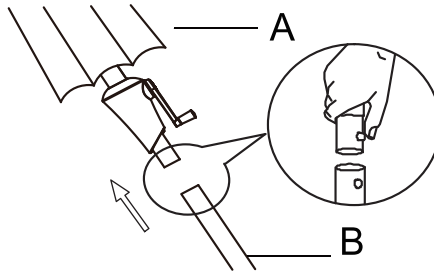

- Step 4** Stand and secure the umbrella in a suitable umbrella base (not included). Secure the umbrella pole firmly by tightening the locking nut as shown in the picture.

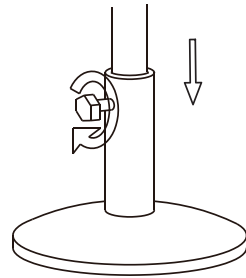

- Step 5** Locate the umbrella in direct sunlight to charge the batteries before first use.

IMPORTANT NOTE:

Please ensure the batteries are charged for at least 8 hours in direct sunlight before first use, failing to follow this step may shorten the lifespan of the re-chargeable batteries and decrease the performance of the lights. Make sure both the switches on the rib are set to the "OFF" 'O' position during charging.

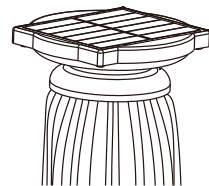
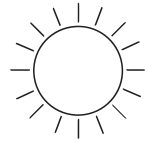

OPERATING INSTRUCTIONS

- Step 1** To open the umbrella, unfasten the storage straps and gently pull out each of the umbrella ribs by hand, at the same time wind the crank handle in a clockwise direction.

CAUTION: Take care not to wind the crank in a counter clockwise direction to open as damage may occur.

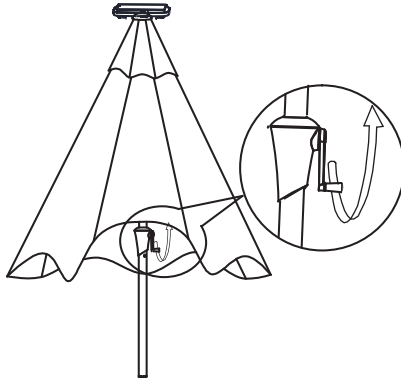

- Step 2** Continue to wind the crank handle until the umbrella canopy is fully open and taut. Take care as overwinding may damage the umbrella.



OPERATING INSTRUCTIONS

Step 3 To tilt the canopy push the tilt button with one hand gently allow the canopy to tilt with the other hand. Release the button to lock in the position.

CAUTION: The tilt option should only be used on days with no wind, use of the tilt function in even a light breeze is not recommended.

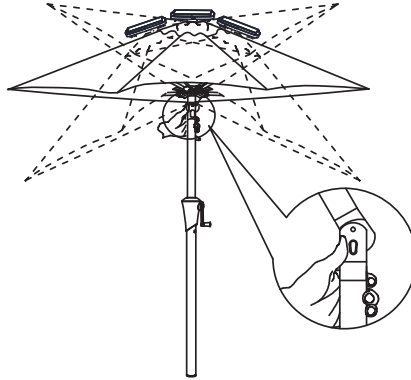

Step 4 To close the umbrella, make sure the canopy is horizontal (never close the umbrella in the tilted position). Wind the crank handle in a counter clockwise direction until the canopy is fully closed.

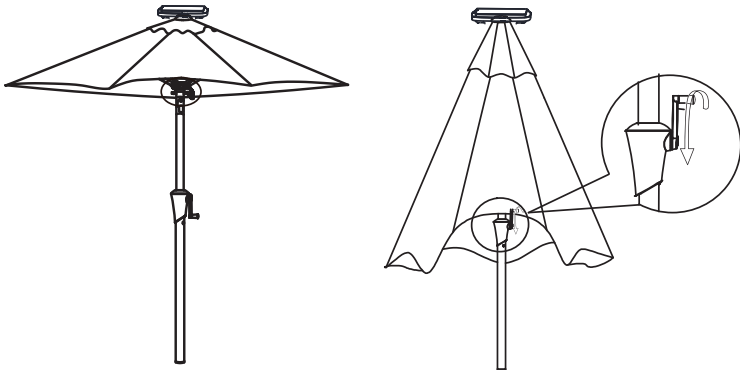

OPERATING INSTRUCTIONS

Step 5 Use the velcro ties to secure the umbrella when not in use.

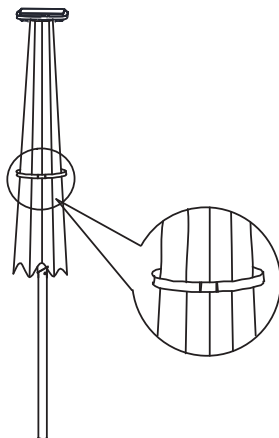

Step 6 Put the raincover to protect the umbrella when not in use.

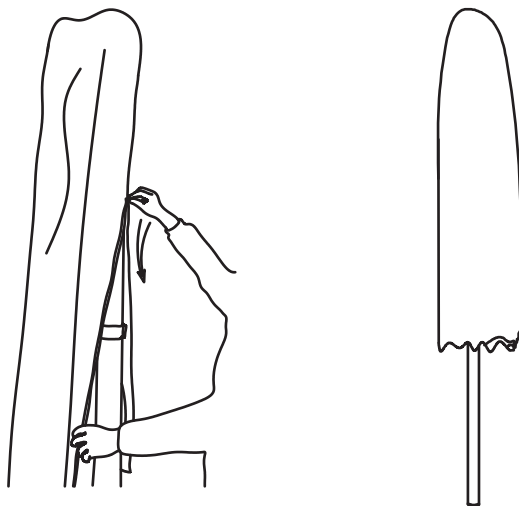

OPERATING THE LIGHTS

To operate the lights, turn the switches (located on the end of one rib) to the ON 'I' position. Ensure the switches are in the OFF 'O' position when not using the lights.

CAUTION: If the lights are left on during the day the batteries will NOT charge.

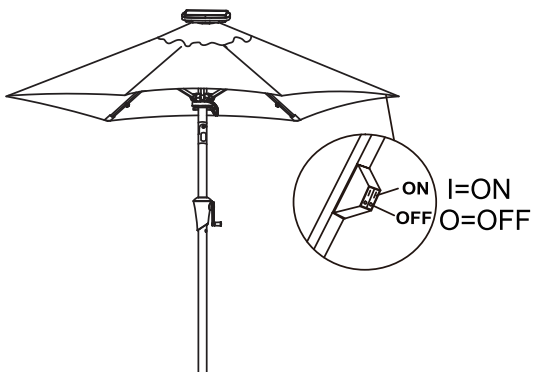

REPLACING THE BATTERY

We recommend that you replace the batteries in your LED umbrella at least once every year (or when you feel that the light is fading more quickly). You can purchase replacement batteries at specialty retailers. You will need 1 piece 18650 Lithium 2000mAh rechargeable battery which is the same as supplied from new.

Failure to insert battery in the correct polarity, as indicated in the battery compartment may shorten the life of the battery or cause the battery to leak. Do not dispose of battery in fire. Battery should be recycled or disposed of as per state and local guidelines. Do not mix old and new batteries. Do not mix Alkaline, Standard (Carbon-Zinc) or rechargeable (Nickel Cadmium) or (Nickel Metal Hydride) batteries.

REPLACING THE BATTERY

- Step 1** Twist the solar panel counter clockwise and remove it from the top of the umbrella.

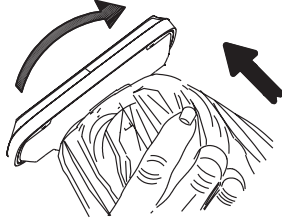

- Step 2** Carefully pull the plug out of the socket under the solar panel.
IMPORTANT: Do not pull the wire to remove the plug.

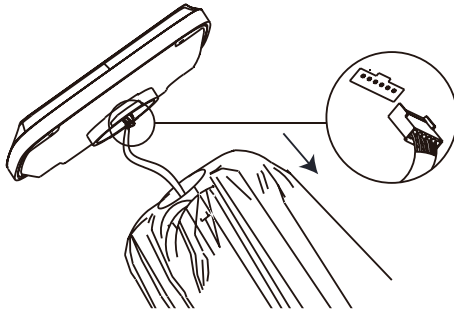

- Step 3** Place the solar panel on a flat surface, then open the battery cover as shown.

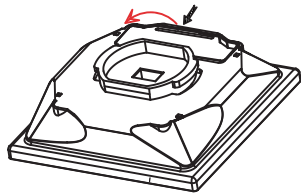

REPLACING THE BATTERY

Step 4

Carefully open the solar panel. Replace the batteries, matching the +/- on the battery with the +/- on the battery case.

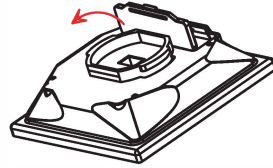

Step 5

Please ensure the O ring is correctly located before replacing the cover.

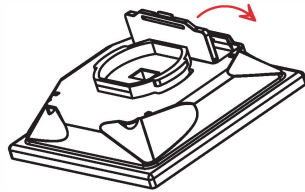

IF YOU FIND A DEFECTIVE PART

We fully stock all parts and components. Any defective part can be quickly replaced. Take note of the defective part number in manual and we will arrange a replacement.

COPYRIGHT

All material in this instruction manual is copyrighted by us.

Any unauthorised use may violate worldwide copyright, trademark and other laws.