

# Assembly Instruction

**Note:**

- 1. Should be assembled on flat ground to keep balance.**
- 2. Before completing the installation, do not tighten the screws.**

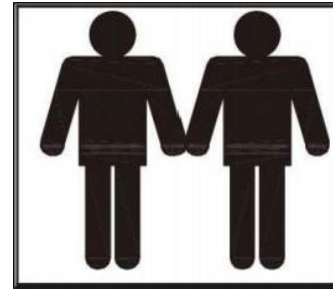
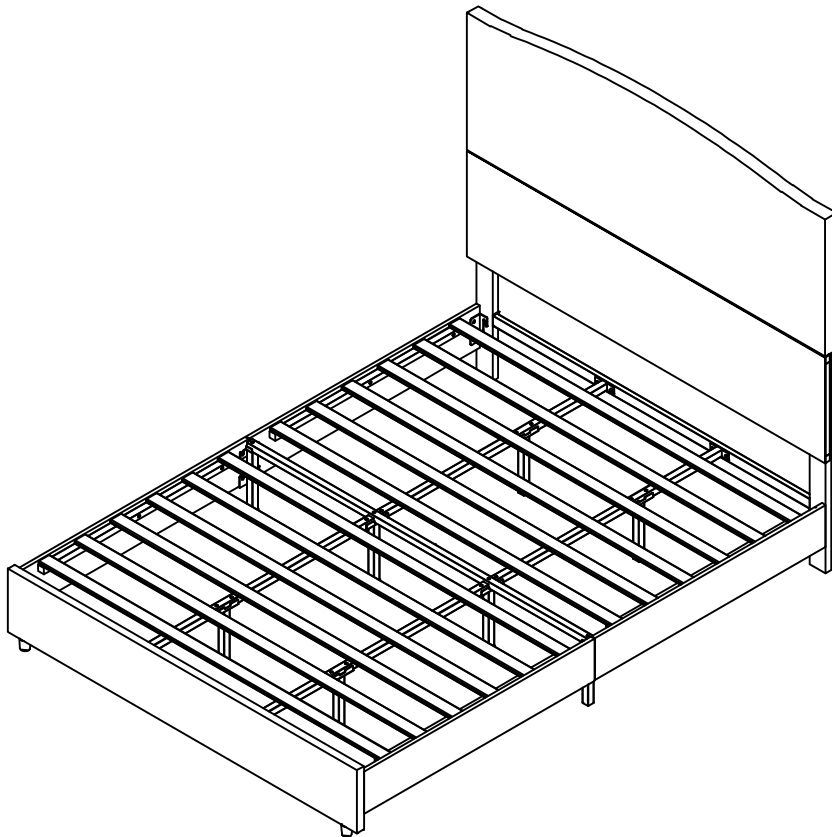

**It needs at least two people to install.**



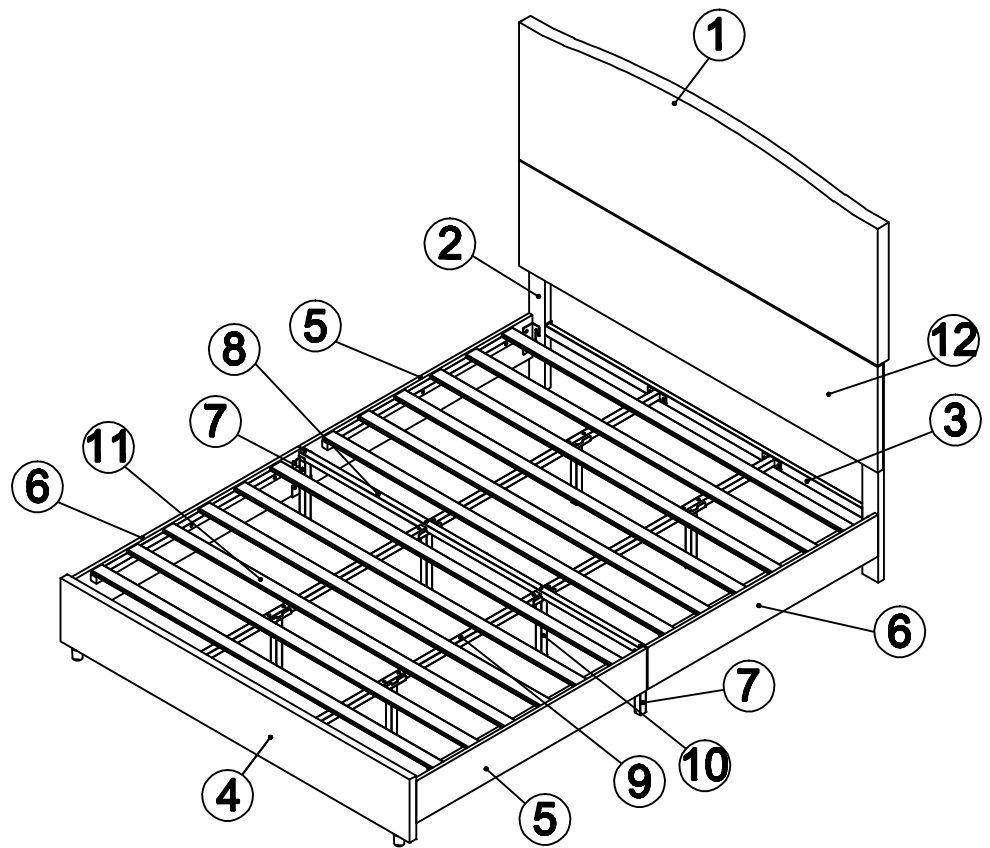

**Before starting the assembly, you must read the whole manual and follow the instructions.**





# Assembly Instruction

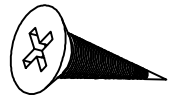
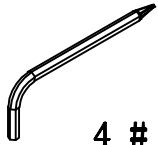

## Hardware arts

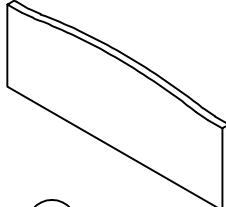
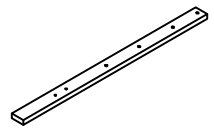
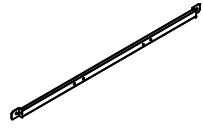
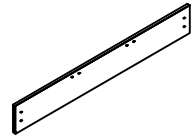
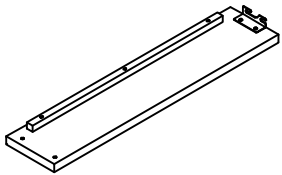
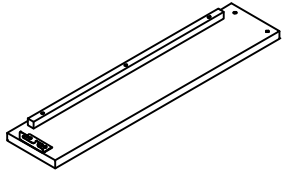
 <p>Ⓐ M8x18 26pcs</p>	 <p>Ⓑ M8x35 14pcs</p>	 <p>Ⓒ M8x45 10pcs</p>	 <p>Ⓓ <math>\varnothing 3 \times 15</math> 6pcs</p>	 <p>Ⓔ 4 # 1pc</p>	
--	--	---	--	--	--

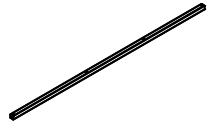
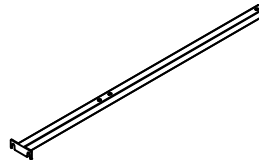
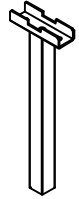
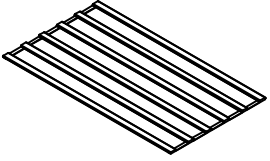
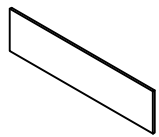
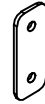

## Part list

 <p>Ⓐ 1 PC</p>	 <p>Ⓑ 2 PCS</p>	 <p>Ⓒ 1 PC</p>	 <p>Ⓓ 1 PC</p>	 <p>Ⓔ 2 PCS</p>	 <p>Ⓕ 2 PCS</p>
 <p>Ⓖ 2 PCS</p>	 <p>Ⓖ 1 PC</p>	 <p>Ⓖ 4 PCS</p>	 <p>Ⓖ 6 PCS</p>	 <p>Ⓖ 2 PCS</p>	 <p>Ⓖ 1 PC</p>
 <p>Ⓖ 3 PCS</p>					<p>Page 3/8</p>

# Assembly Instruction

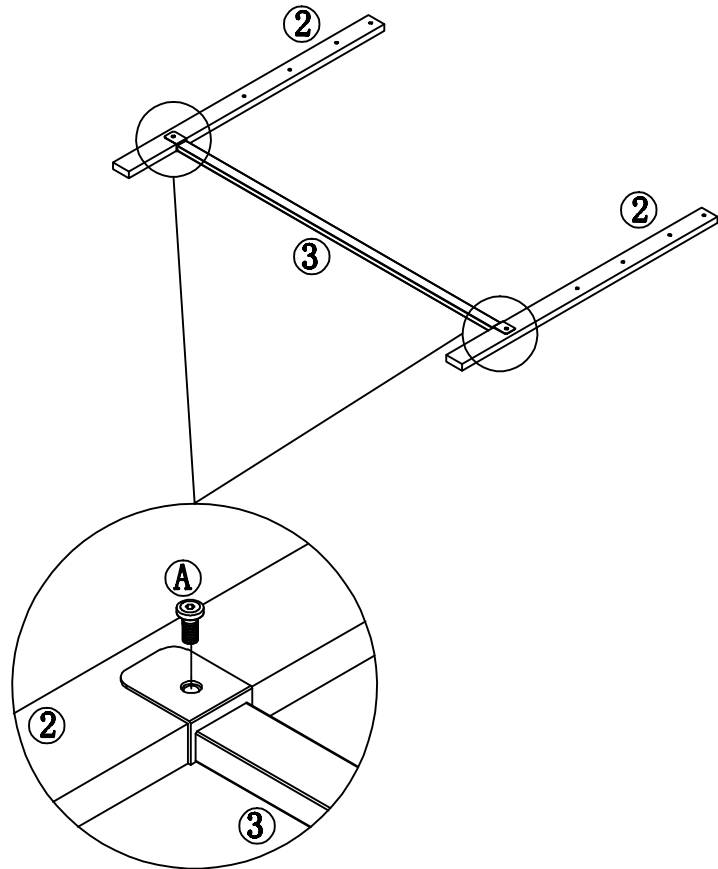

A	 M8x18	2pcs
E		1pc



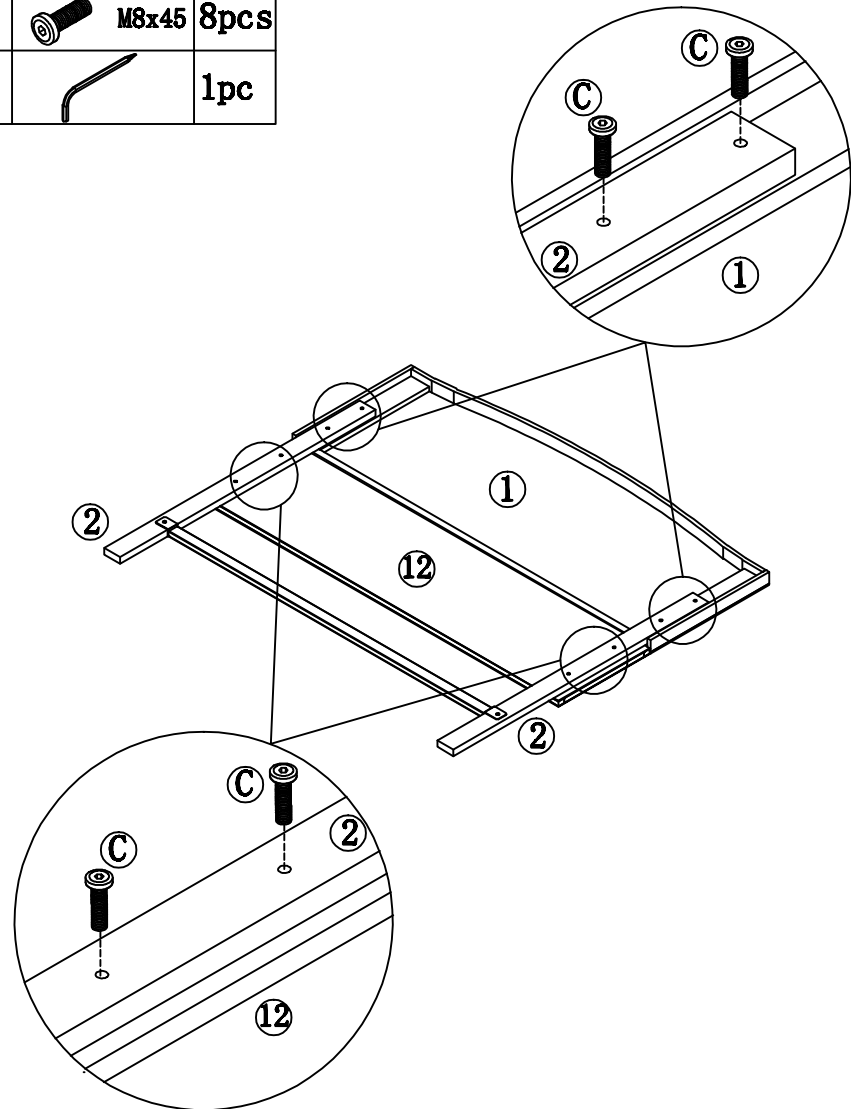

C	 M8x45	8pcs
E		1pc



# Assembly Instruction

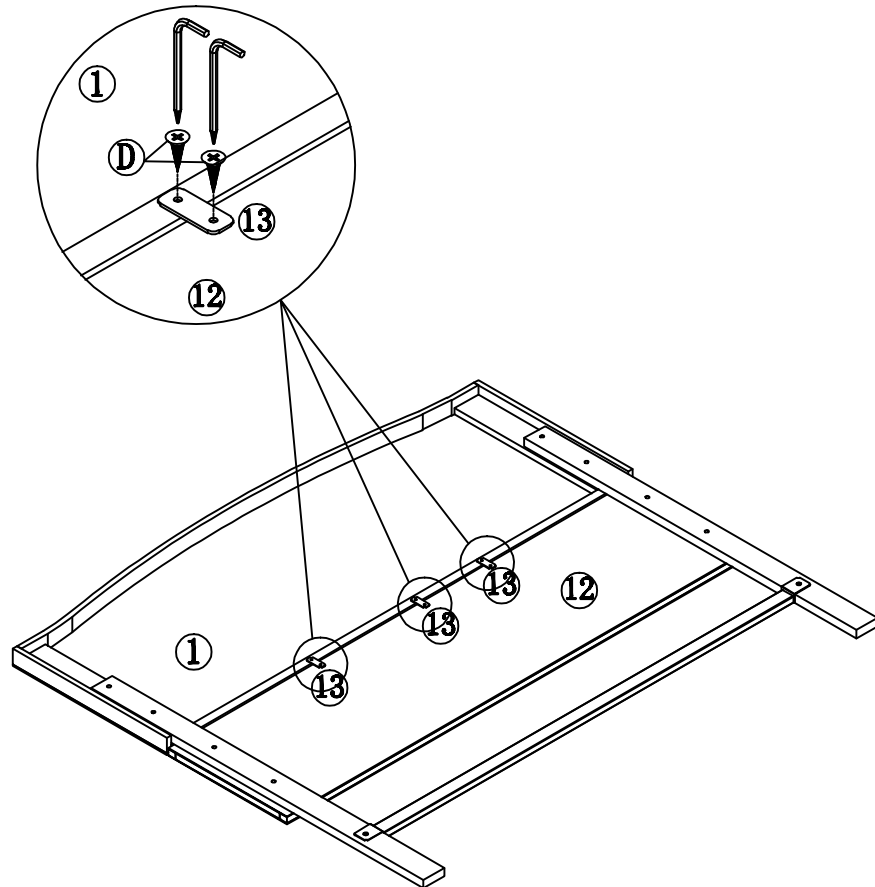

D	 $\varnothing 3 \times 15$ 6pcs
E	 1pc



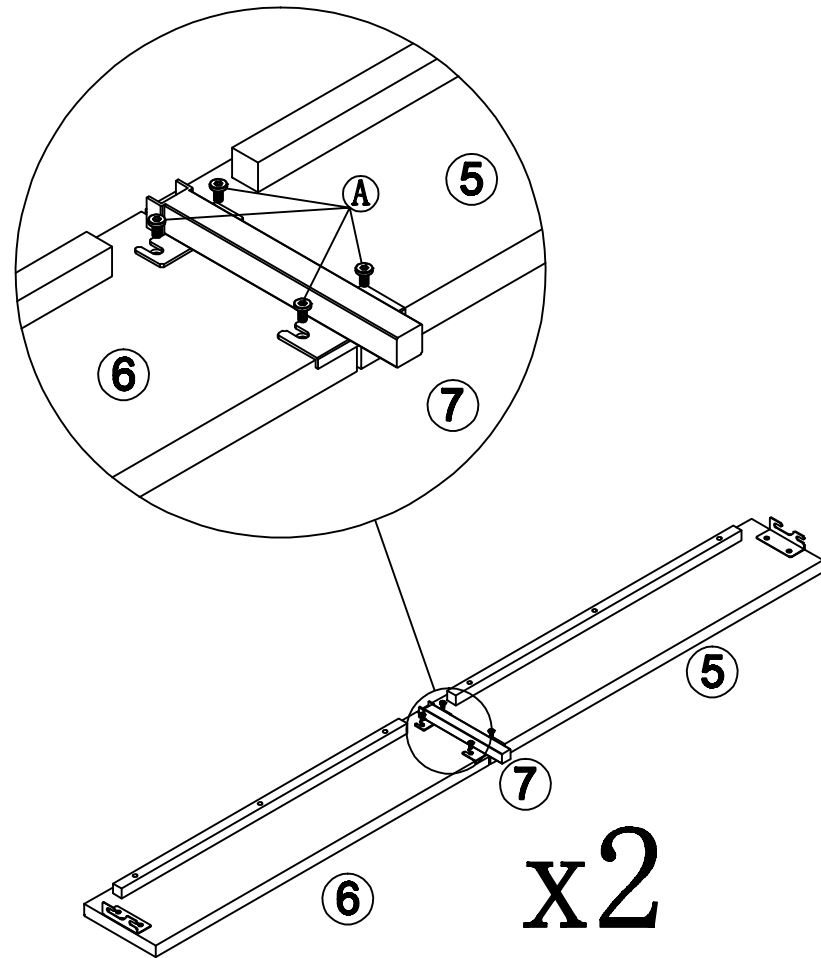

A	 M8x18 8pcs
E	 1pc



# Assembly Instruction

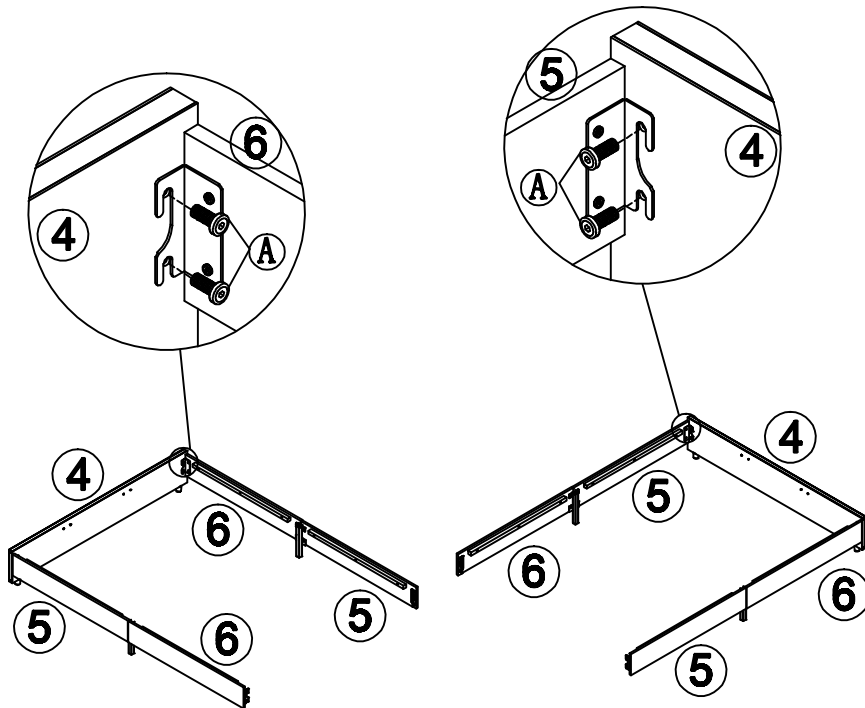

A		M8x18	4pcs
E			1pc



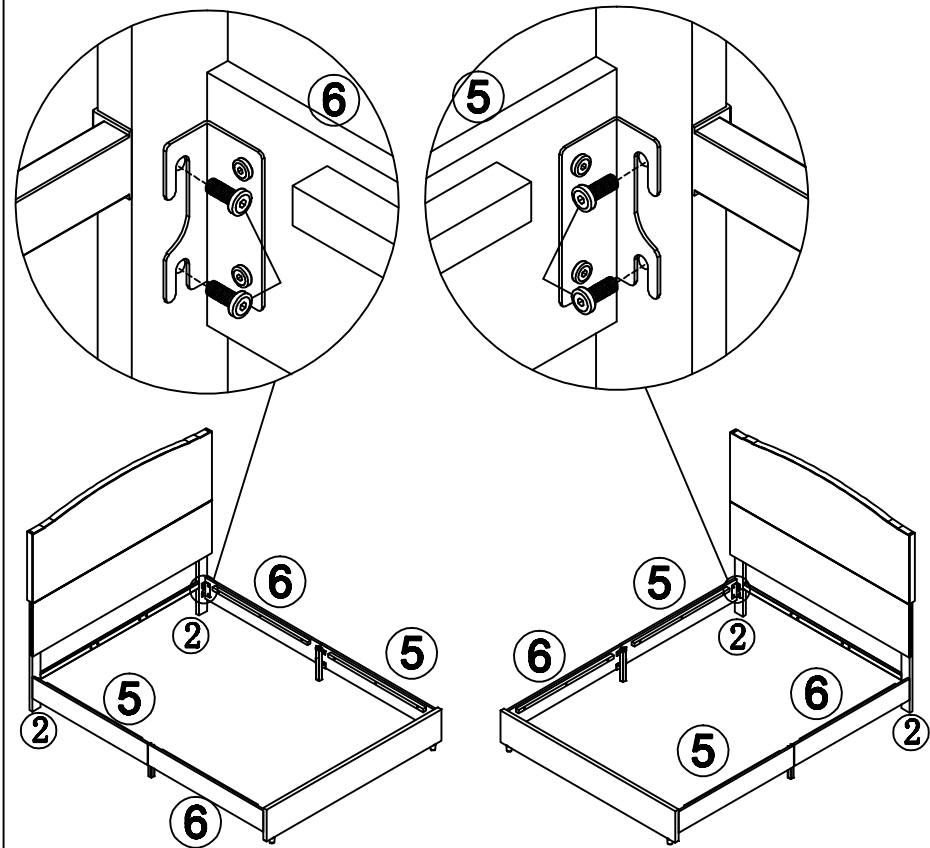



A		M8x18	4pcs
E			1pc

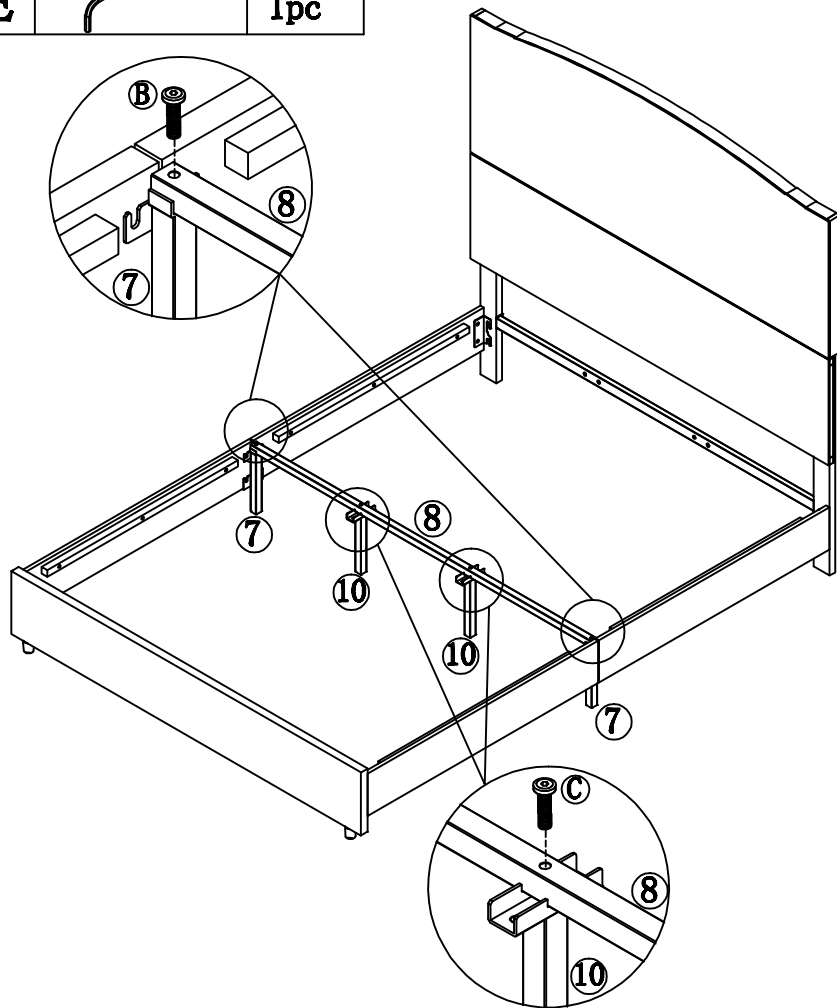

# Assembly Instruction

<b>B</b>	 M8x35	2pcs
<b>C</b>	 M8x45	1pc
<b>E</b>		1pc



<b>A</b>	 M8x18	8pcs
<b>B</b>	 M8x35	4pcs
<b>E</b>		1pc

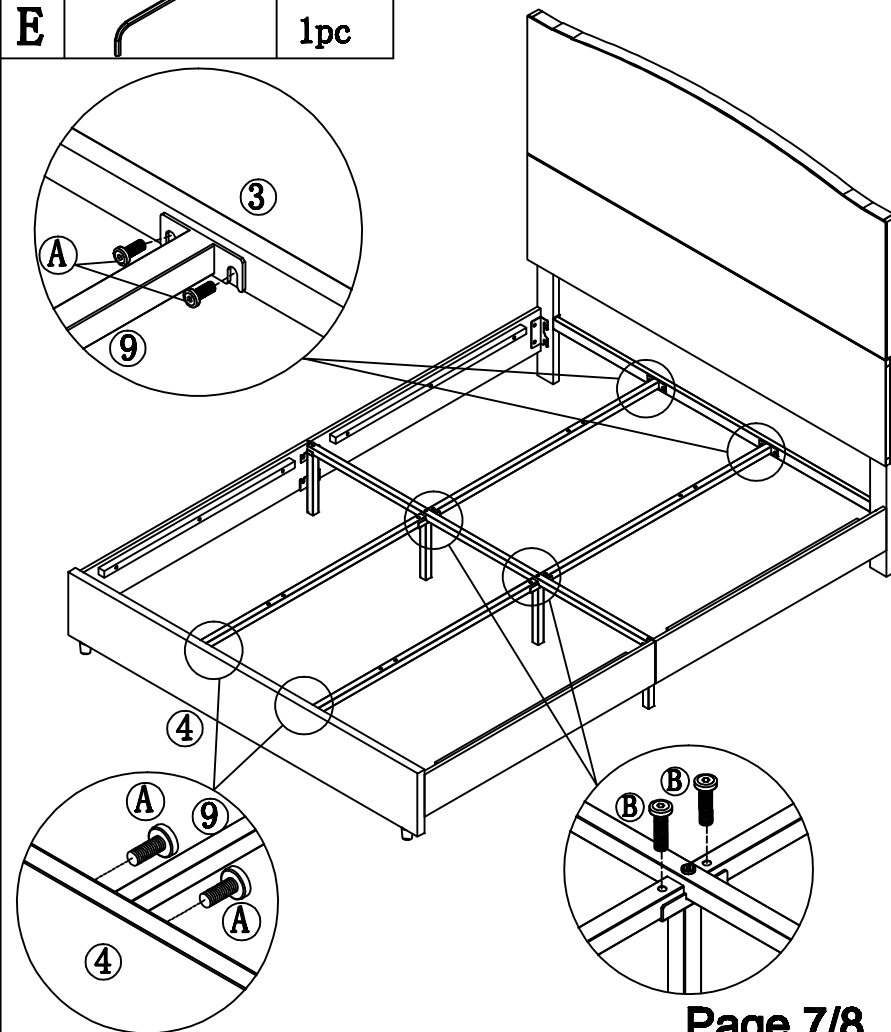

# Assembly Instruction

B		M8x35	8pcs
E			1pc

