

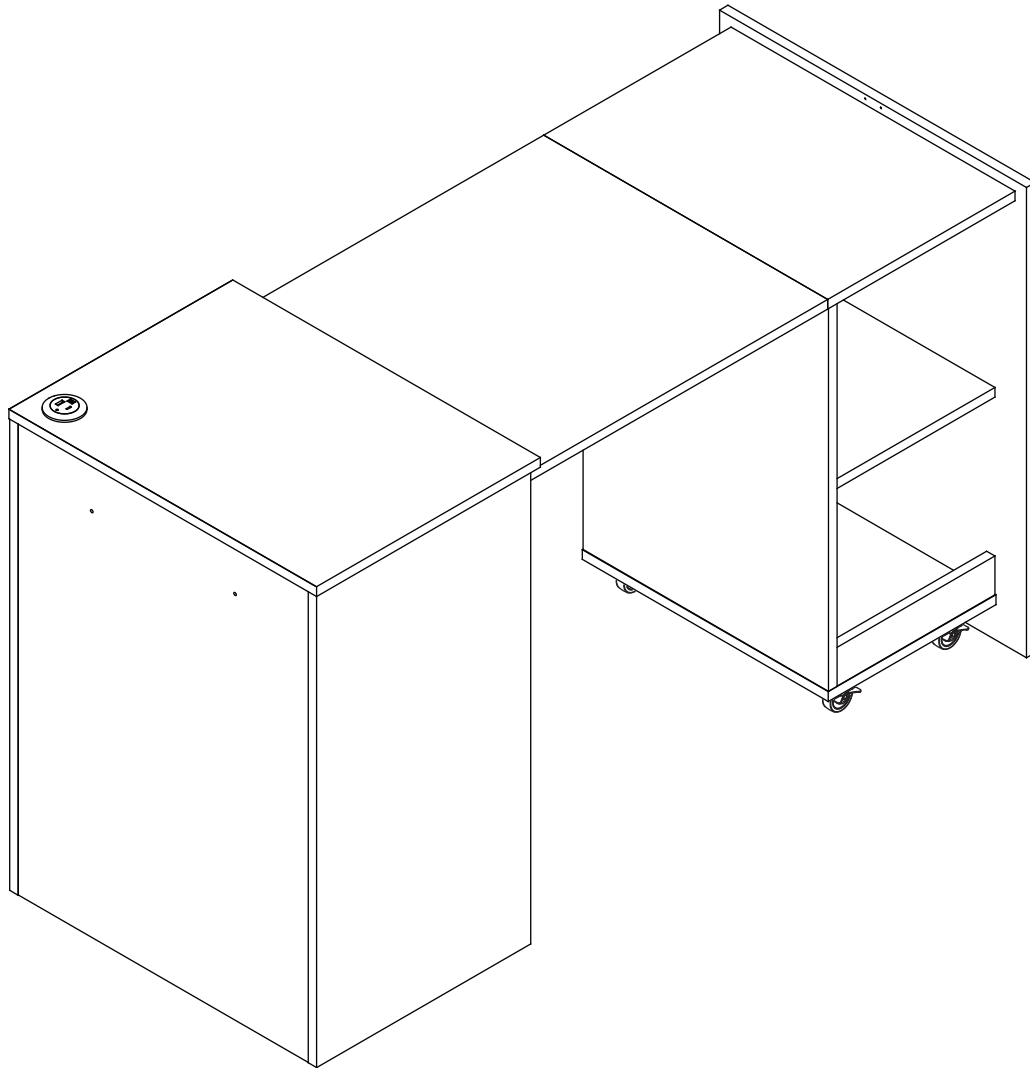

# Folding Table Assembly Guide

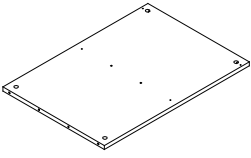
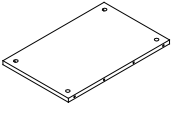

# PARTS LIST

 ① 1pc	 ② 1pc	 ③ 2pcs	 ④ 1pc
 ⑤ 1pc	 ⑥ 1pc	 ⑦ 1pc	 ⑧ 1pc
 ⑨ 1pc	 ⑩ 1pc	 ⑪ 1pc	

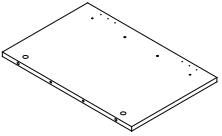
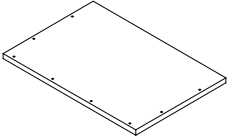
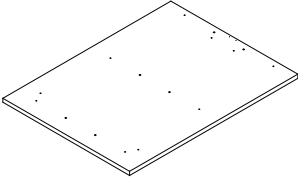
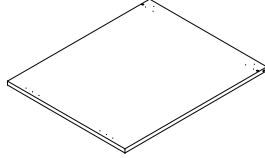
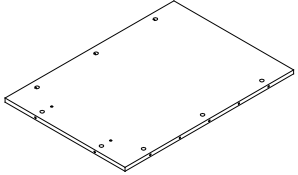
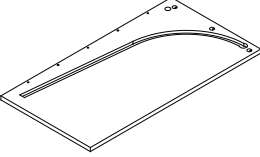
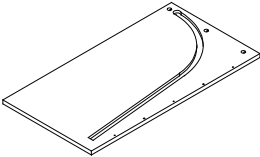
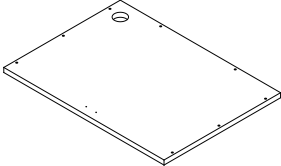
## Warnings

It is not intended for use by children under 5 years of age. Children must be under adult supervision when using this product.

It is forbidden for children to climb on or play with this product to avoid serious injury caused by tipping or toppling.









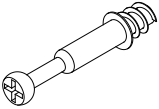

During the assembly process, keep all small parts out of the reach of children, as they may be fatal if swallowed or inhaled. To avoid the risk of suffocation, please keep all packaging materials away from children.

## NOTED:

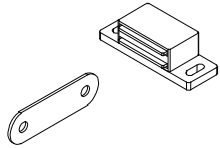
It is recommended that this item be assembled by two adults.

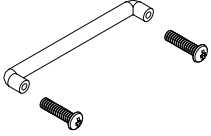
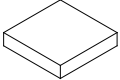
Assemble this item on a soft surface, such as cardboard or carpet, to protect the finish.

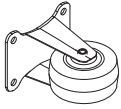
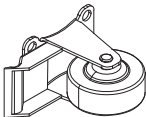
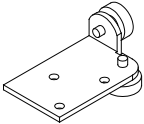
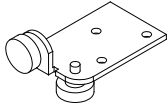
# PARTS LIST

<p><b>A</b></p>  <p><math>\phi 6 \times 35 \text{mm}</math></p> <p>34pcs</p>	<p><b>B</b></p>  <p><math>\phi 15 \times 10 \text{mm}</math></p> <p>34pcs</p>	<p><b>C</b></p>  <p><math>\phi 6 \times 30 \text{mm}</math></p> <p>16pcs</p>	<p><b>D</b></p>  <p>M3x14mm</p> <p>22pcs</p>
<p><b>E</b></p>  <p>M5x14mm</p> <p>16pcs</p>	<p><b>F</b></p>  <p>1pc</p>	<p><b>G</b></p>  <p>2pcs</p>	<p><b>H</b></p>  <p>1pc</p>
<p><b>I</b></p>  <p>6pcs</p>	<p><b>J</b></p>  <p>2pcs</p>	<p><b>K</b></p>  <p>8pcs</p>	<p><b>L</b></p>  <p>2pcs</p>
<p><b>O</b></p>  <p>2pcs</p>	<p><b>P</b></p>  <p>1pc</p>	<p><b>Q</b></p>  <p>1pc</p>	<p><b>R</b></p>  <p>M2.5x8mm</p> <p>3pcs</p>
<p><b>S</b></p> 			

## IMPORTANT:

1. Do not tighten bolts /screws completely until all bolts / screws are lined up and inserted into holes.
2. Do not over tighten screws and bolts to avoid stripping.
3. Please use hand tools to assemble this product. Do not use power tools.

# How to install cam lock

## Cam Screw

Clockwise rotate the CAM SCREW until the shoulder is against the surface of the board.

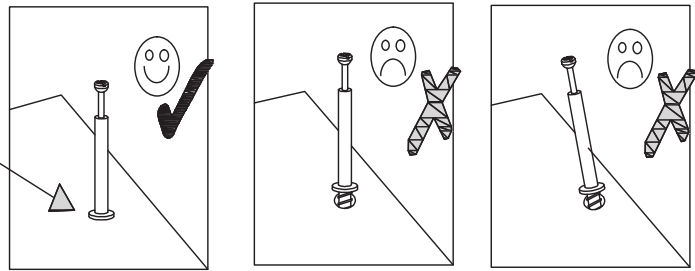

## Hidden Cam

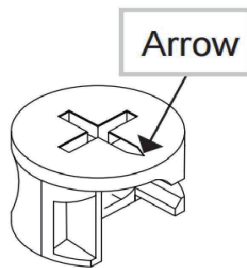

Hidden Cam

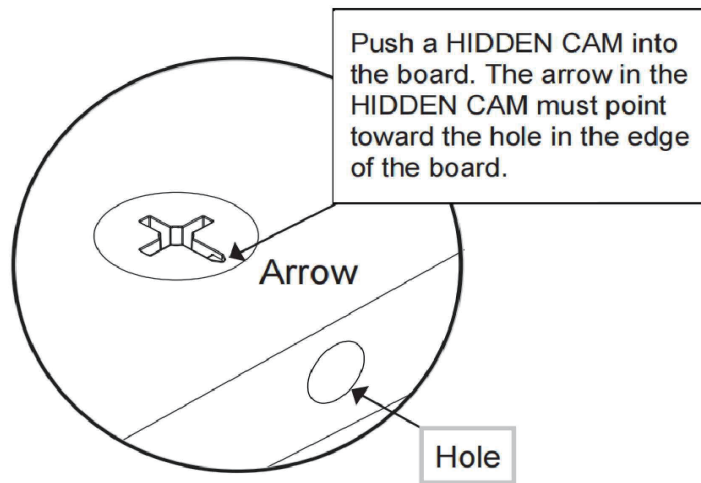

Insert the CAM SCREW into the HIDDEN CAM.  
Clockwise rotate to tighten the HIDDEN CAM.

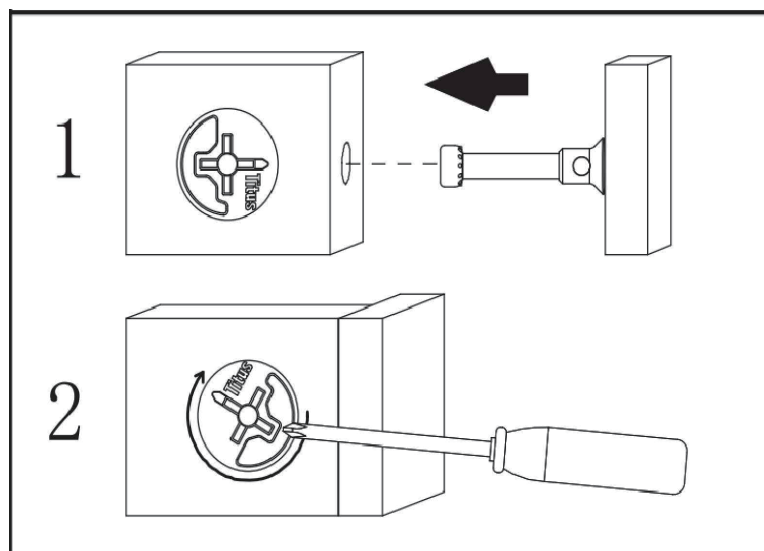

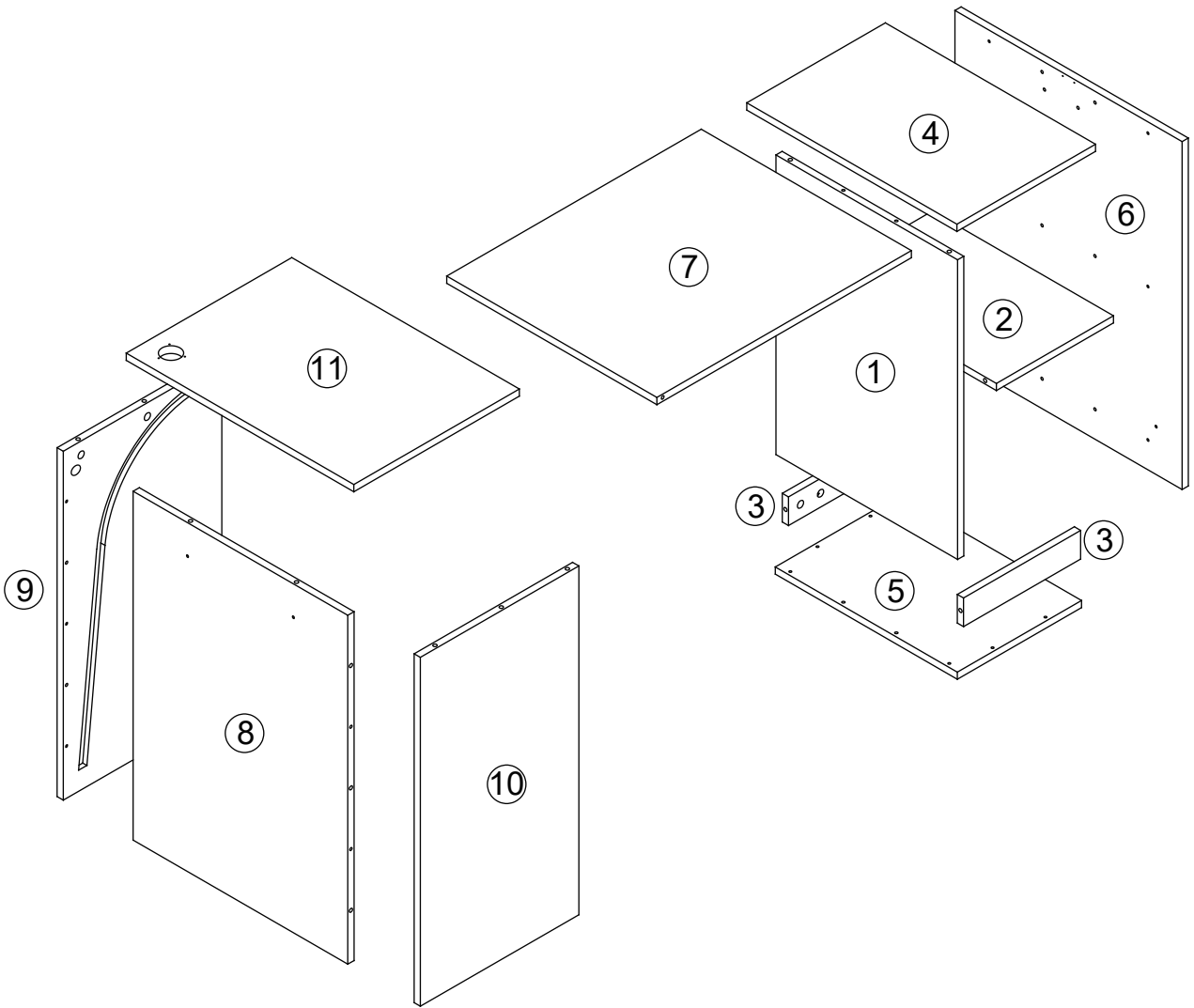

# Step 1



A x 34

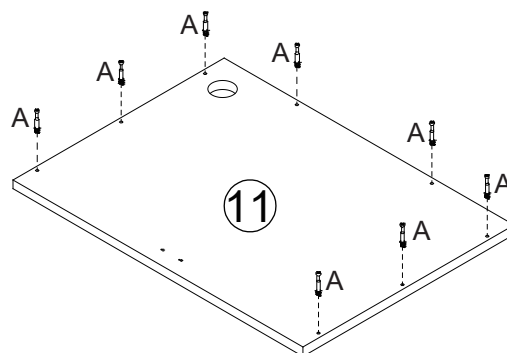
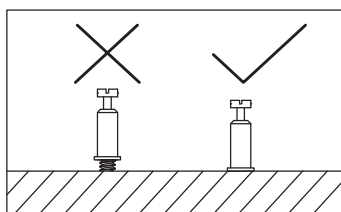
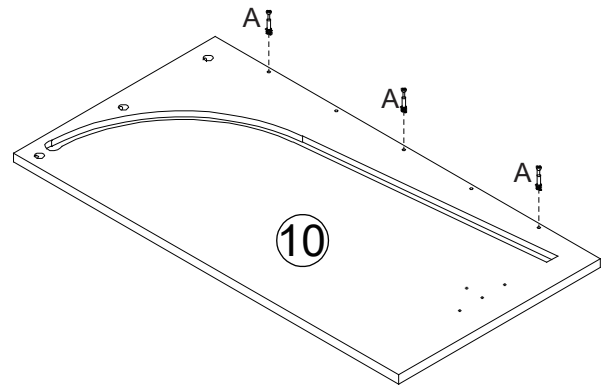
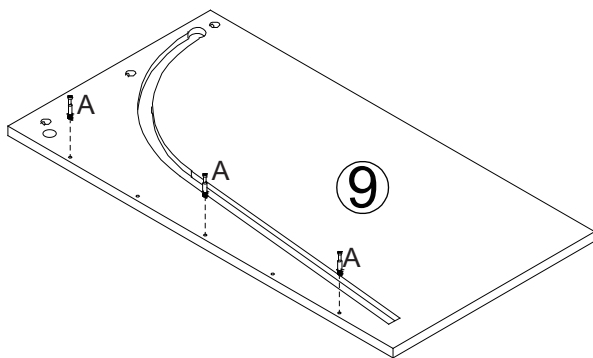
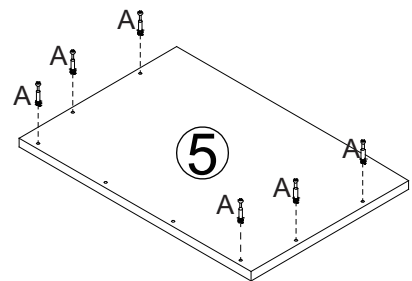
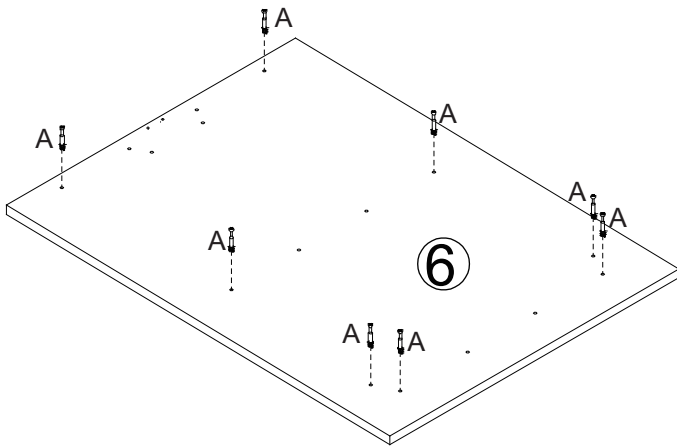
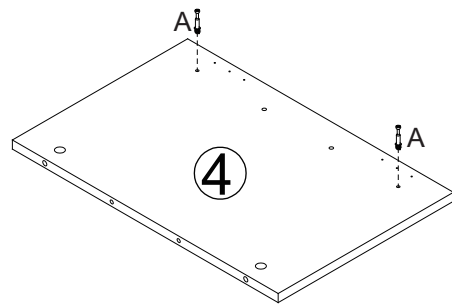
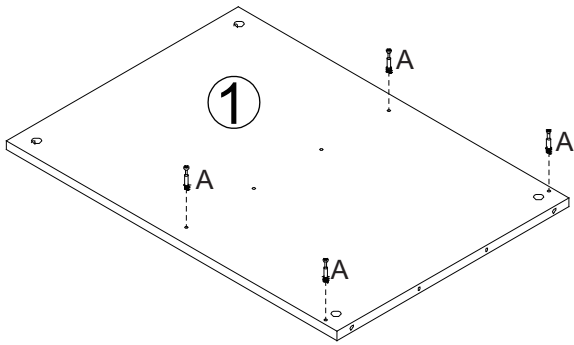

φ6x35mm



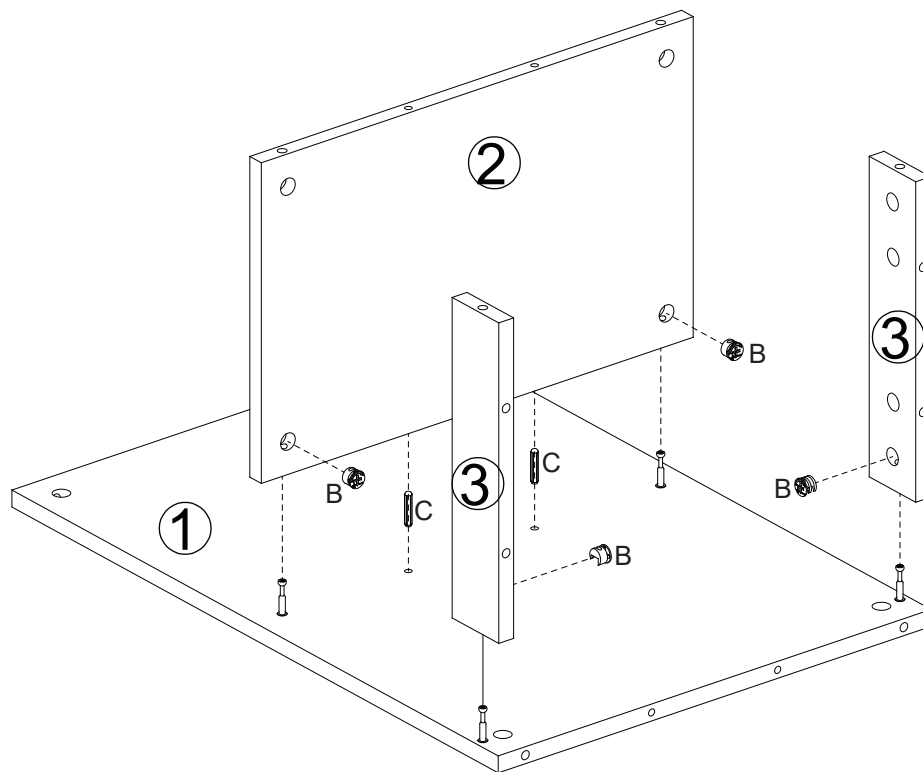

# Step 2

<b>B x 4</b>  $\phi 15 \times 10 \text{mm}$	<b>C x 2</b>  $\phi 6 \times 30 \text{mm}$
--	---



# Step 3

<b>B x 8</b>  $\phi 15 \times 10 \text{mm}$	<b>C x 4</b>  $\phi 6 \times 30 \text{mm}$
--	---

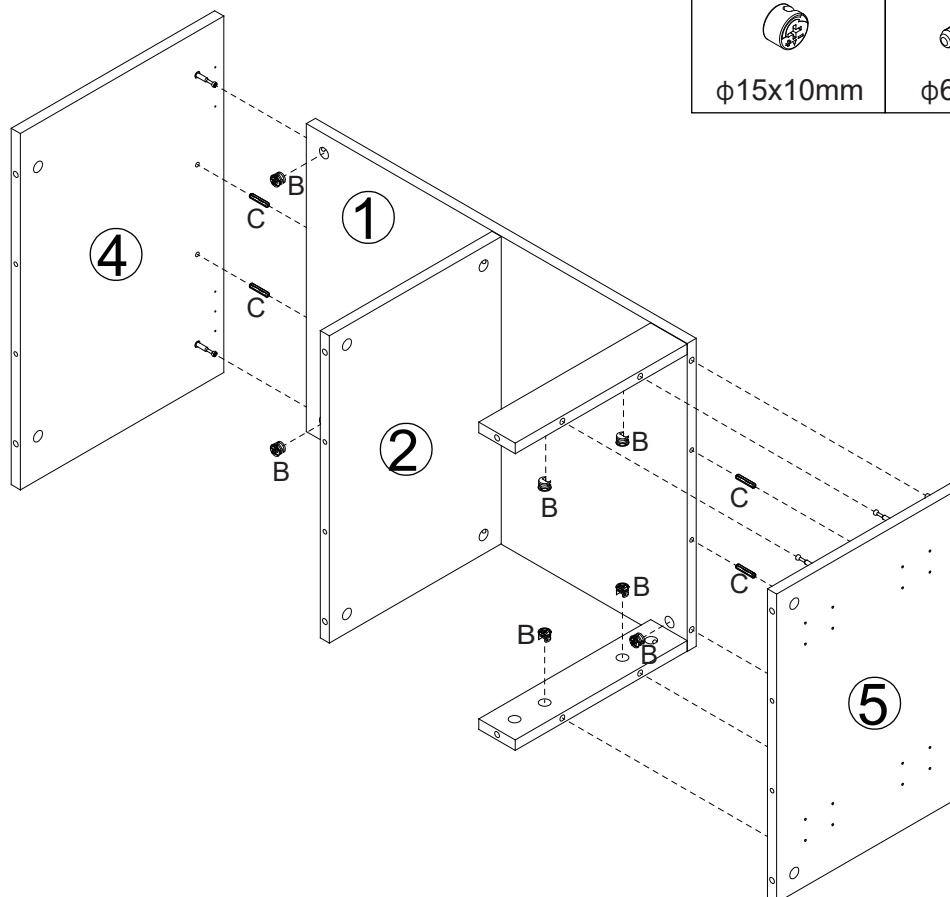

# Step 4

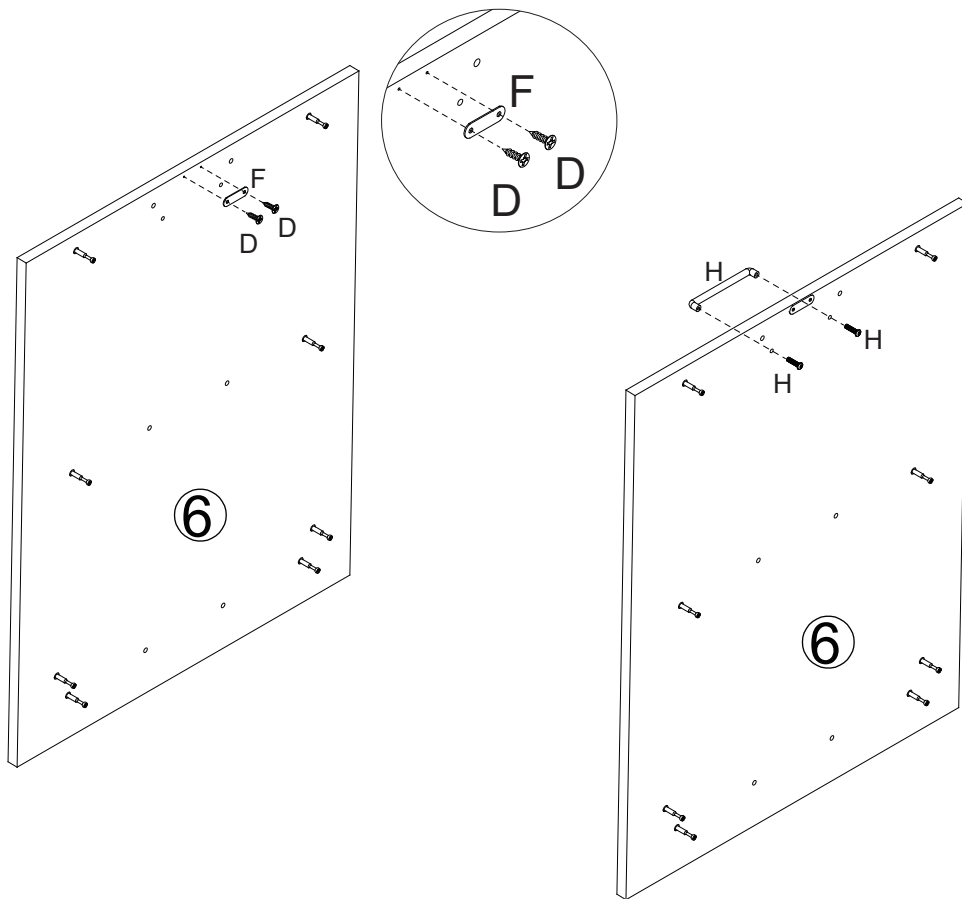

D x 2 M3x14mm	F x 1
	H x 1

# Step 5

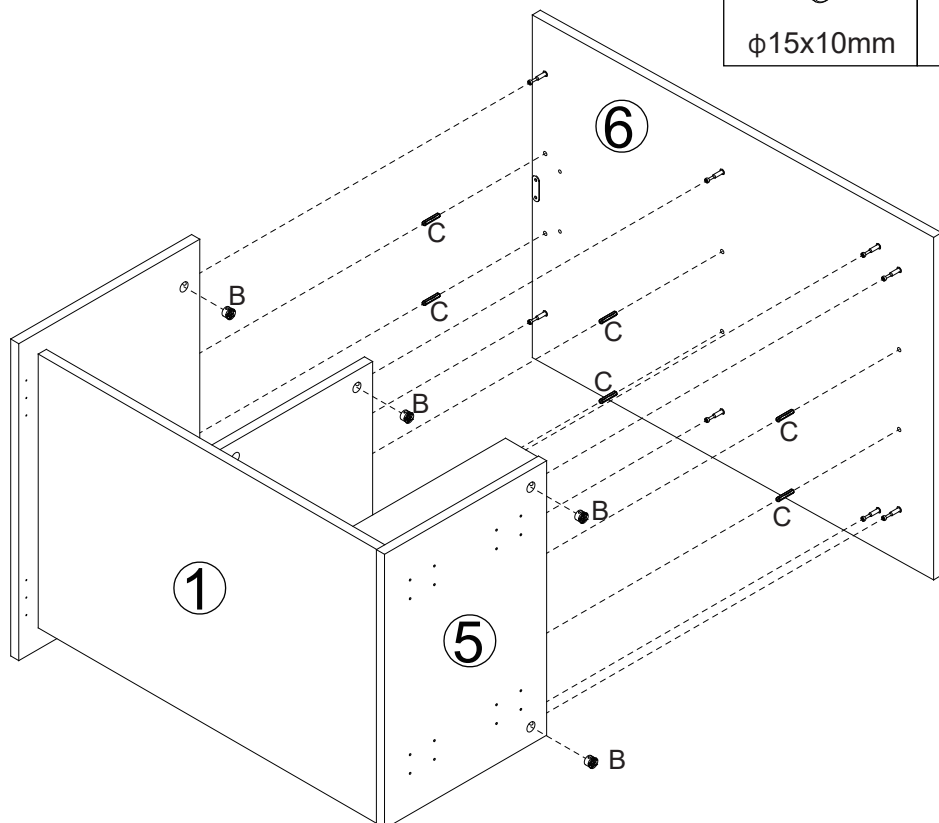

B x 8 φ15x10mm	C x 6 φ6x30mm
-------------------	------------------

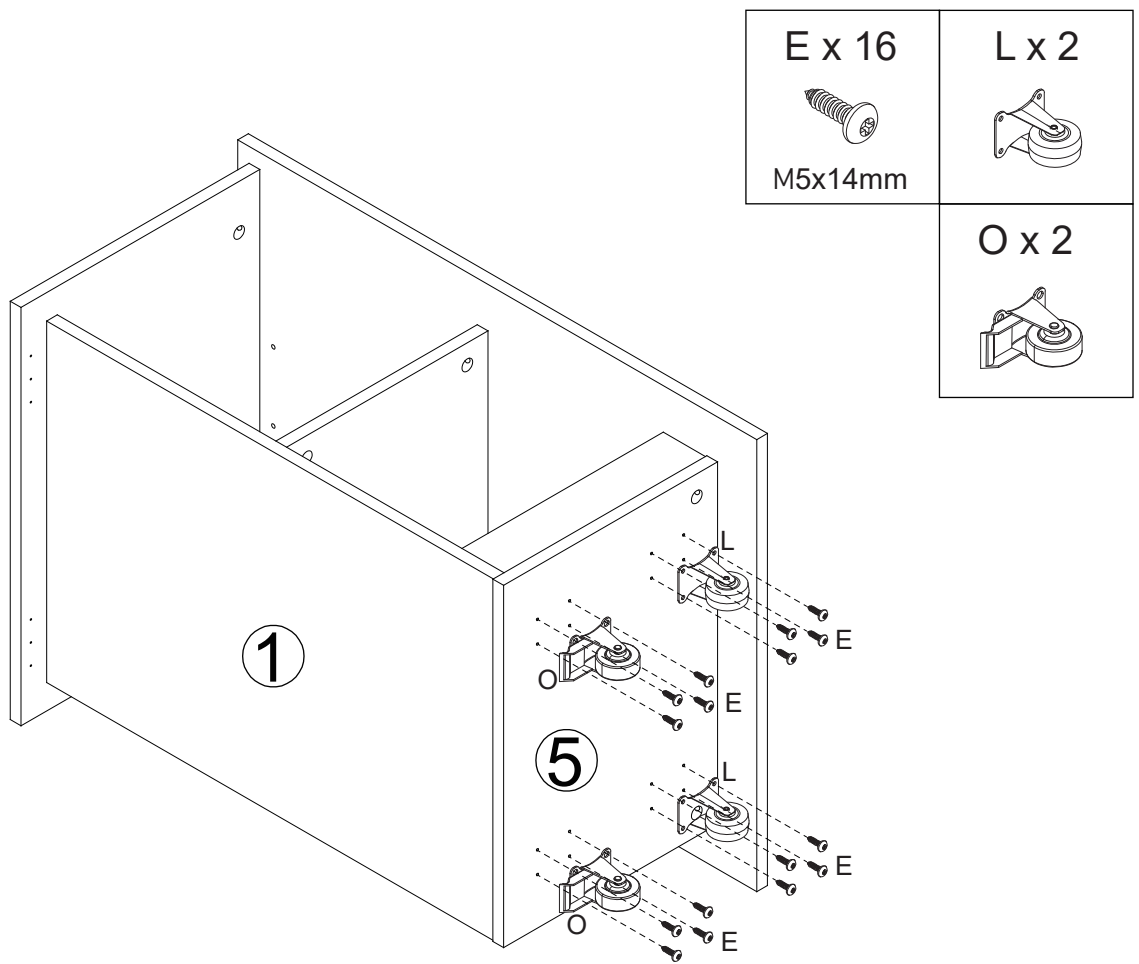

# Step 6

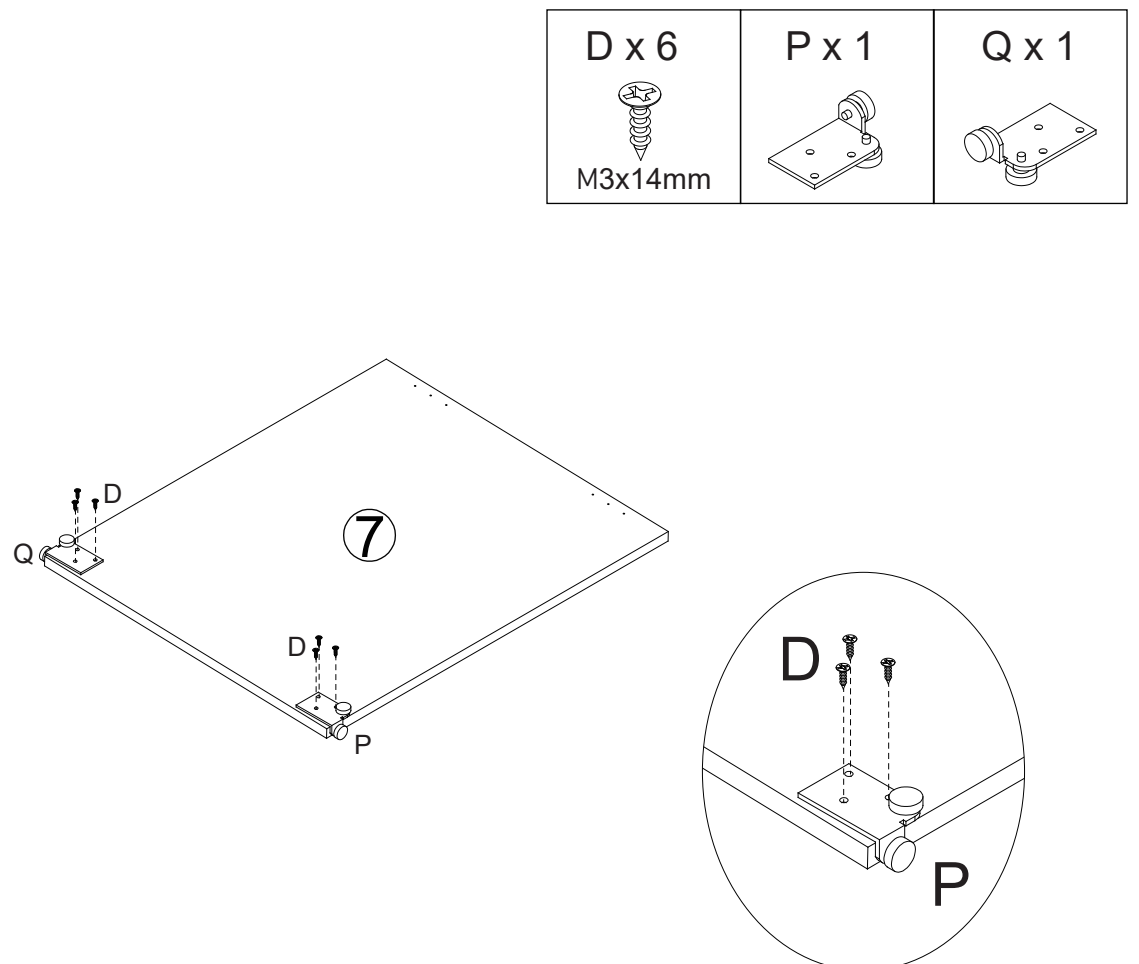

# Step 7



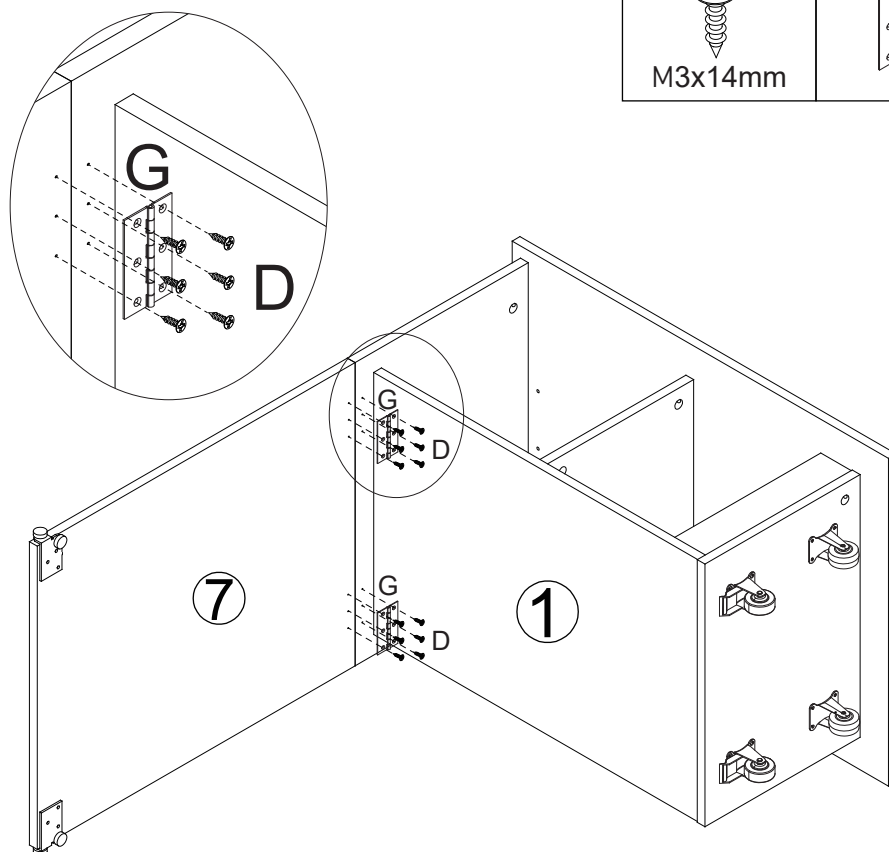

# Step 8

<b>D x 12</b>  M3x14mm	<b>G x 2</b> 
---	---



# Step 9

<b>B x 6</b>  $\phi 15 \times 10 \text{mm}$	<b>C x 4</b>  $\phi 6 \times 30 \text{mm}$
--	---

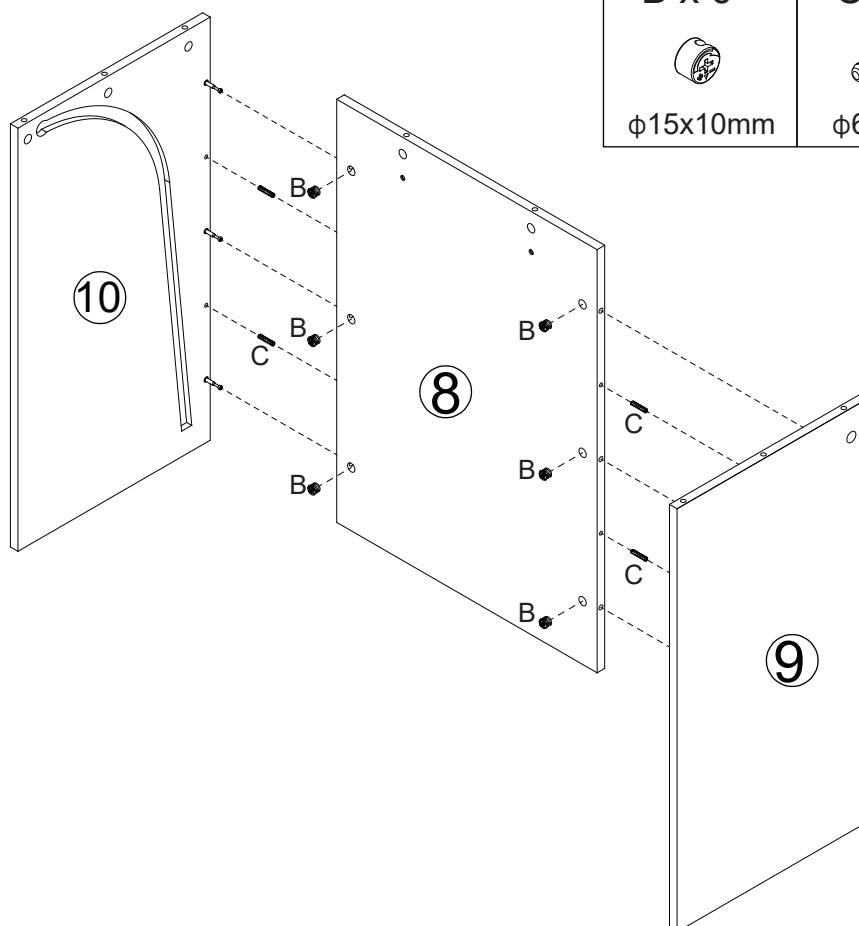

## Step 10

1 x 6

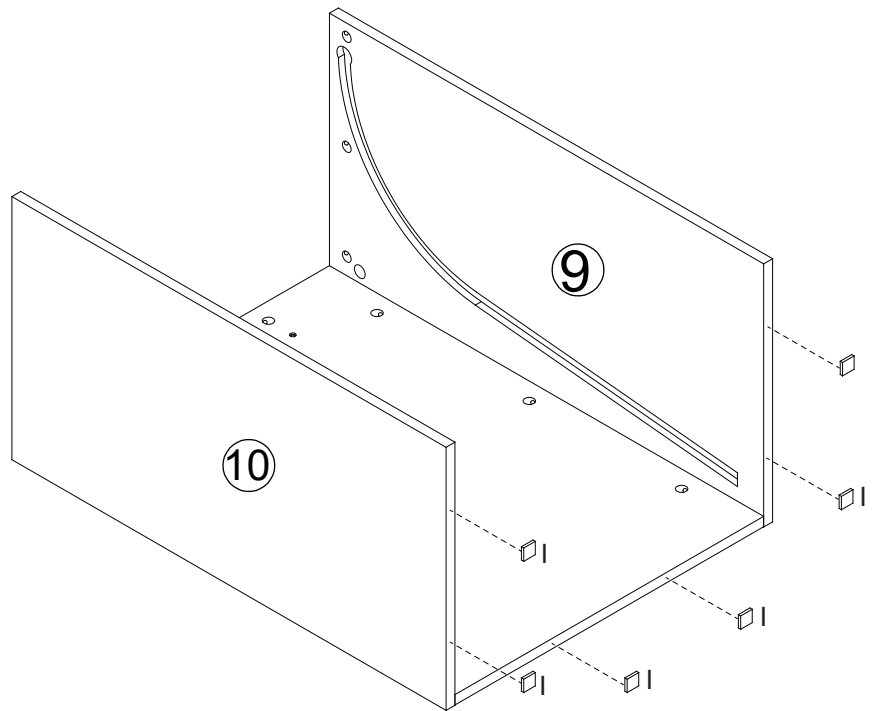

Peel off the sticker and attach Part 1 to the bottom

## Step 11

Insert the pre-installed roller into the outer groove as shown in the diagram.

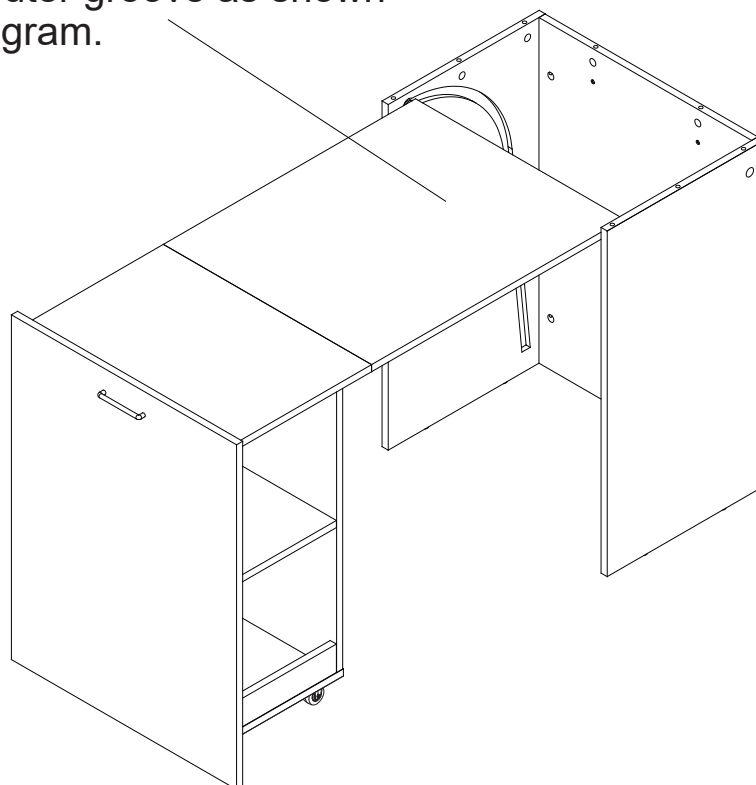

# Step 12

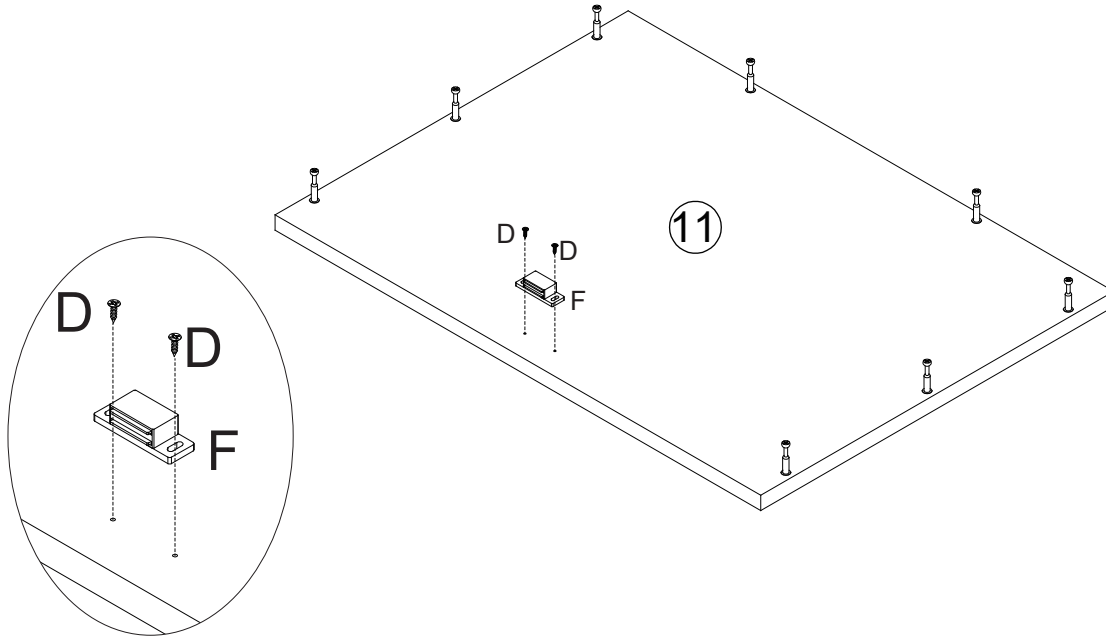
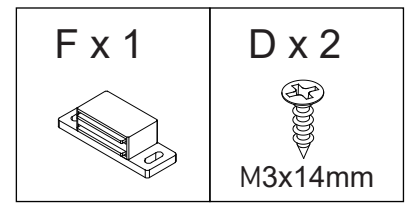

# Step 13

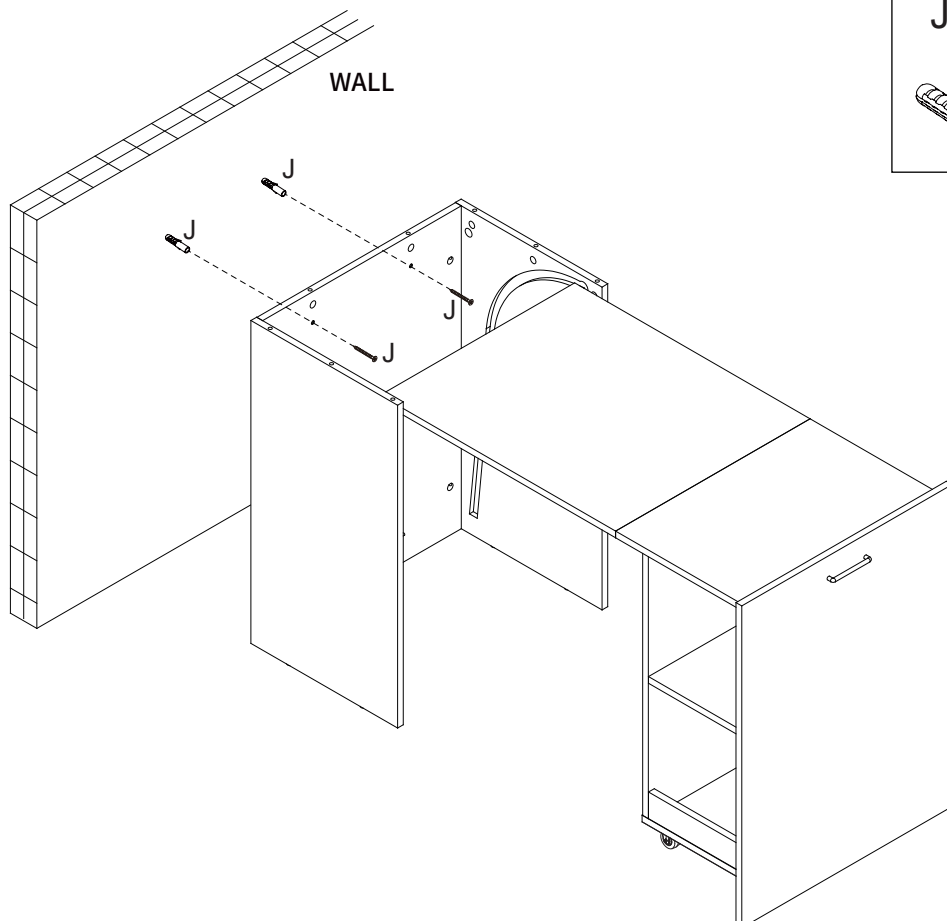
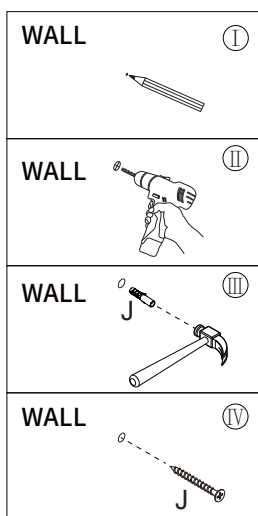
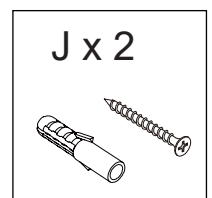

# Step 14

B x 8



φ15x10mm

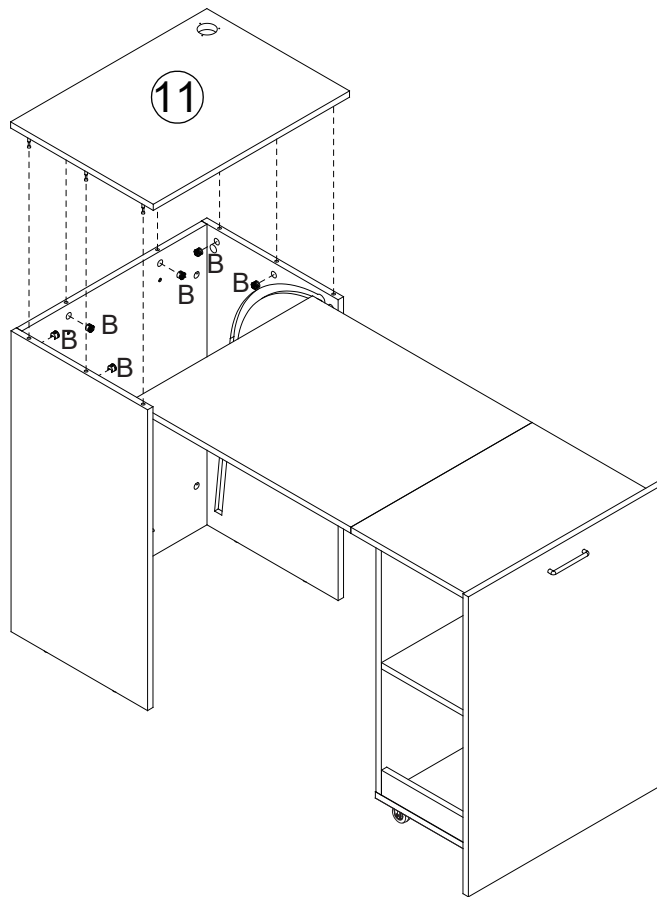

# Step 15

R x 3



M2.5x8mm

S x 1



**1.** Turn right to open the lid.

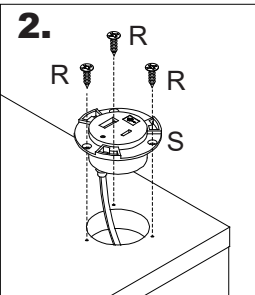
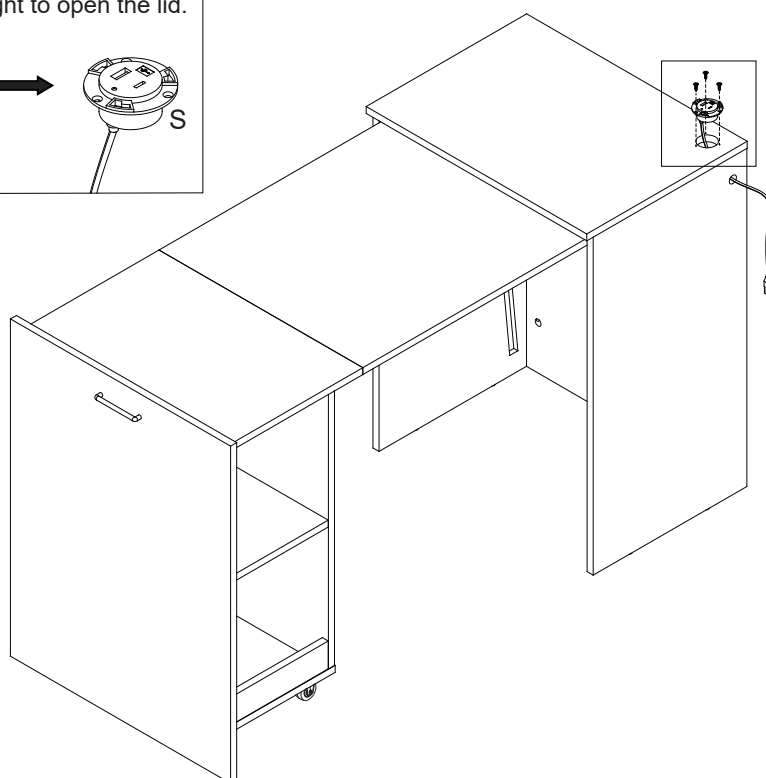
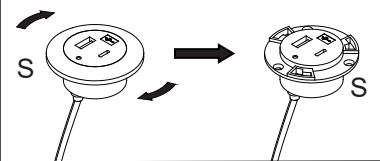

**3.**

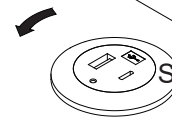

Turn to the left to tighten the lid.