

ASSEMBLY GUIDE

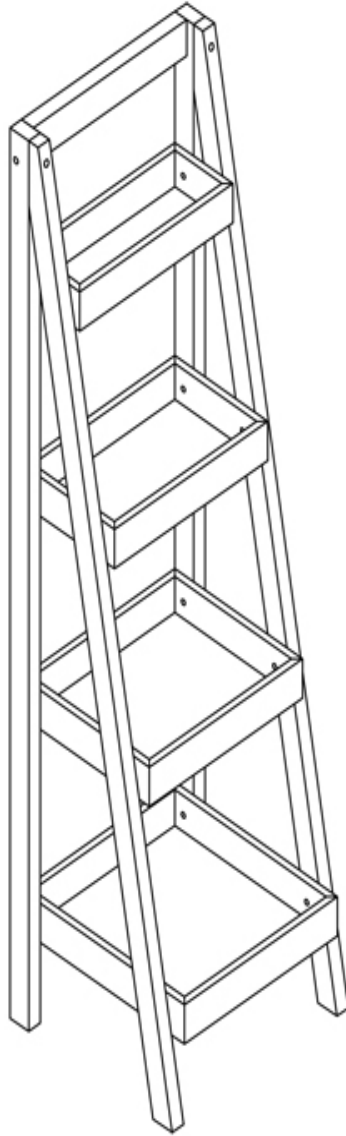

Note: This instruction booklet contains important safety information, please read and keep for future reference.

PARTS IDENTIFICATION

- Ensure that all parts and components are located before beginning assembly. Parts are labeled to help distinguish similar parts from each other. Use this PARTS IDENTIFICATION to help identify similar parts.
- Assemble on a soft surface to prevent damage to the product finish.
- Two people are needed for assembly.
- Estimated assembly time is approximately 0.5 hour.

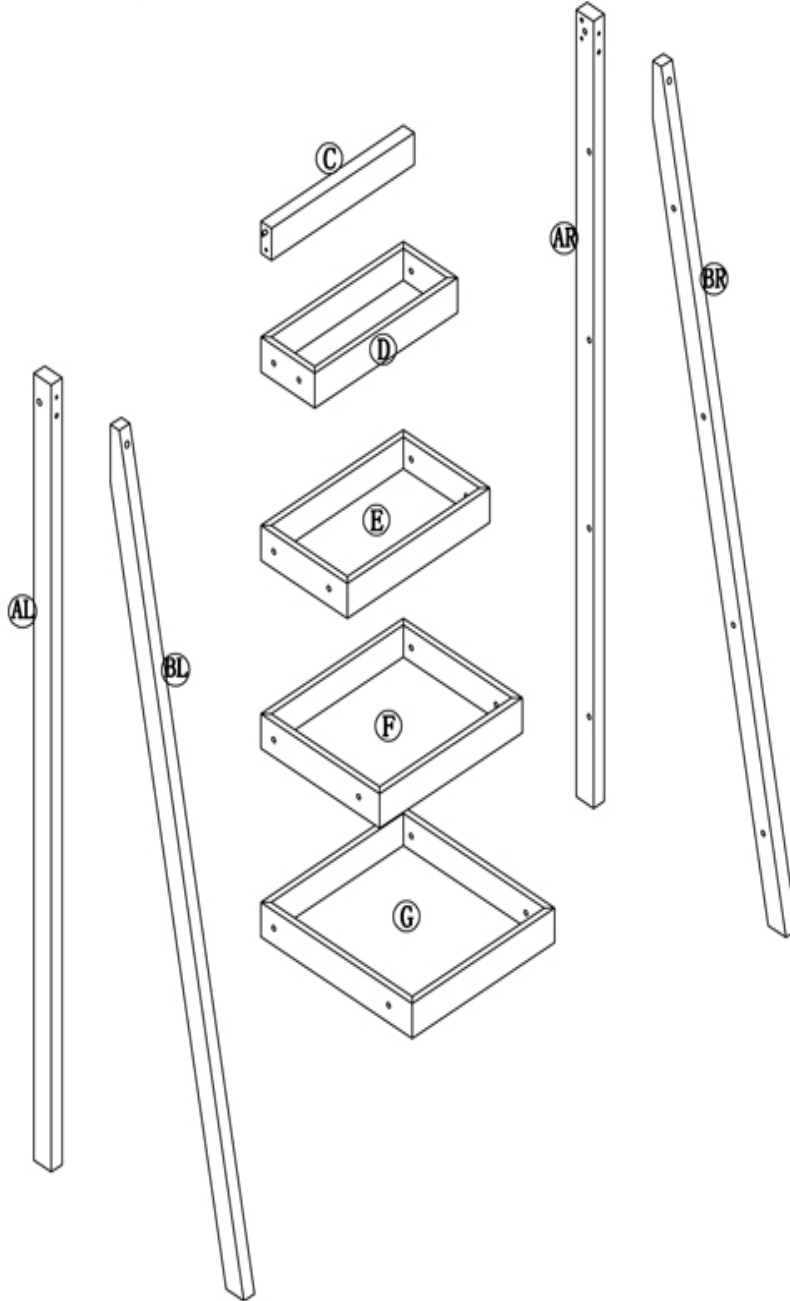

(AL)LEG-1PC
(BR)LEG-1PC
(E)SHELF-1PC

(AR)LEG-1PC
(C)BAR-1PC
(F)SHELF-1PC

(BL)LEG-1PC
(D)SHELF-1PC
(G)SHELF-1PC

HARDWARE IDENTIFICATION

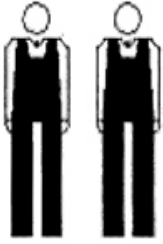

(R1) PLASTIC CAP -4PCS

(R2) FLAT HEAD SCREW
ST3.5X40-4PCS

TOOL REQUIRED



PHILLIPS HEAD
SCREWDRIVER



SHORT FLAT
SCREWDRIVER



(R3) NUT-4PCS

(R4) FLAT HEAD SCREW
M6X25-16PCS





(R1) PLASTIC CAP: 2PCS 

(R2) FLAT HEAD SCREW ST3.5X40: 2PCS 

(R3) NUT: 2PCS 

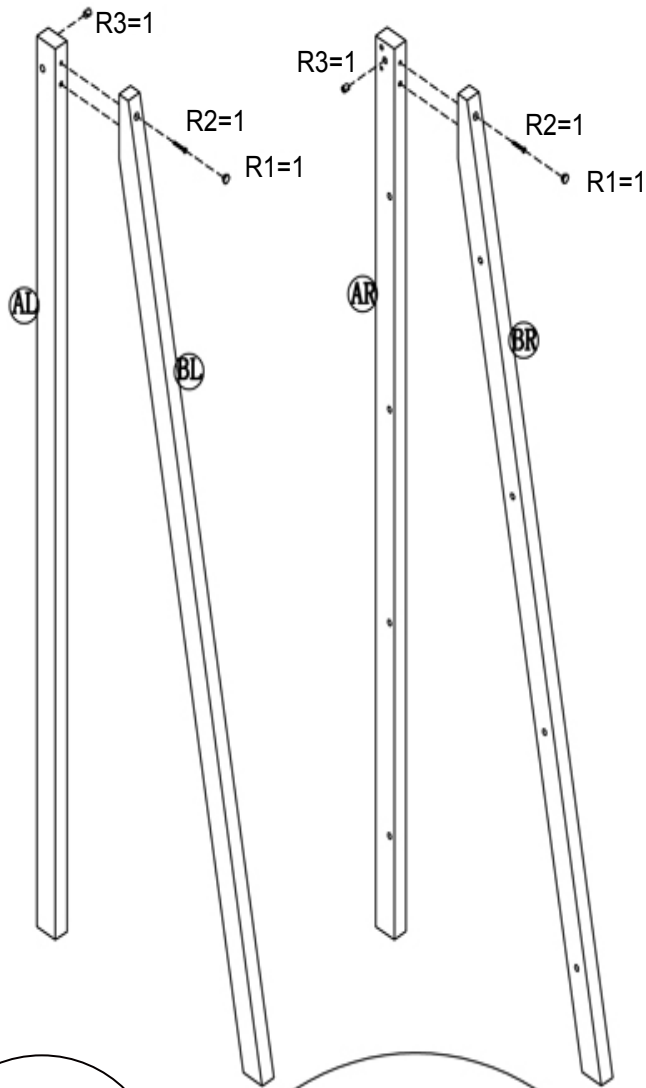



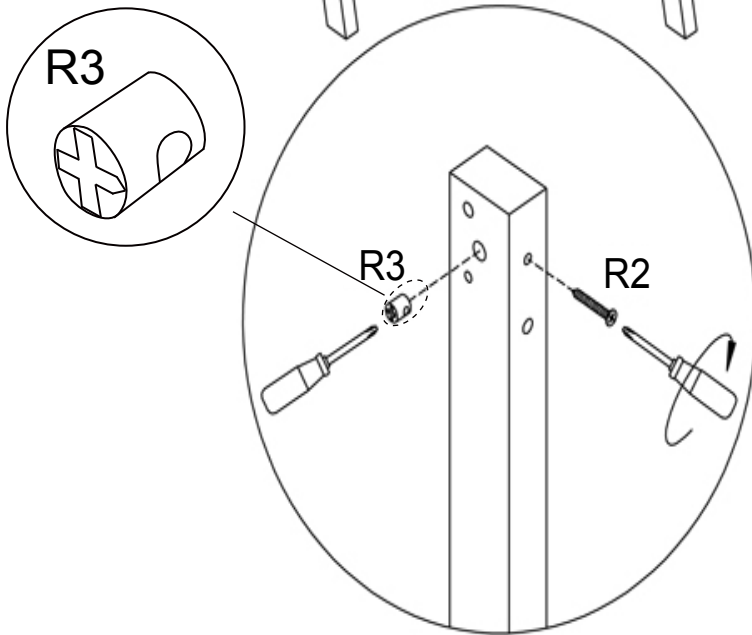

1. a) Fasten leg BL & BR to leg AL & AR, using 2 flat head screw R2 (ST3.5X40) and 2 nut R3, then insert 2 plastic cap R1.

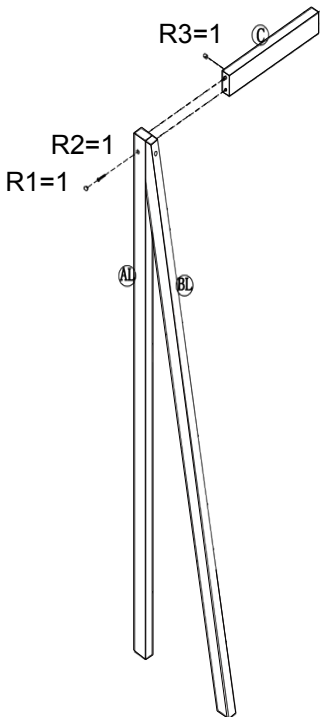
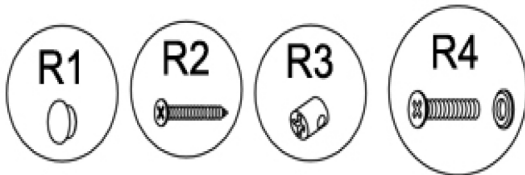
Note: Please install R3 as shown on the photo with arrow face to the direction of R2 coming into join with.





- (R1) PLASTIC CAP: 1 PC 
- (R2) FLAT HEAD SCREW ST3.5X40: 1 PC 
- (R3) NUT: 1 PC 
- (R4) FLAT HEAD SCREW M6X25: 8 PCS 



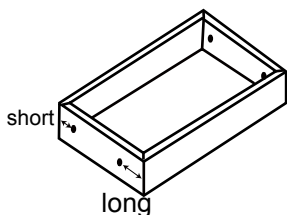
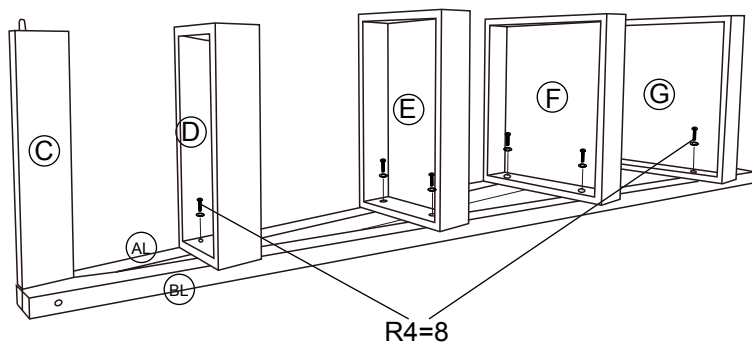

2.a) Fasten bar C to leg AL, using 1 flat head screw R2 (ST3.5X40) and 1 nut R3, then insert 1 plastic cap R1.

b) Fasten shelf D, E, F, G to leg AL & BL, using 8 flat head screw R4 (M6x25).

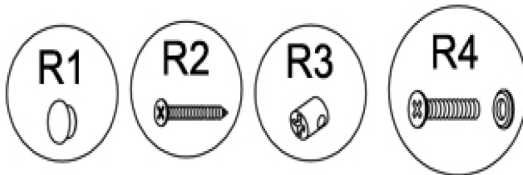
Note: Pls put the "short" side of shelf on back and "long" side in front as shown on the photo.





- (R1) PLASTIC CAP: 1PC 
- (R2) FLAT HEAD SCREW ST3.5X40: 1PC 
- (R3) NUT: 1PC 
- (R4) FLAT HEAD SCREW M6X25: 8PCS 

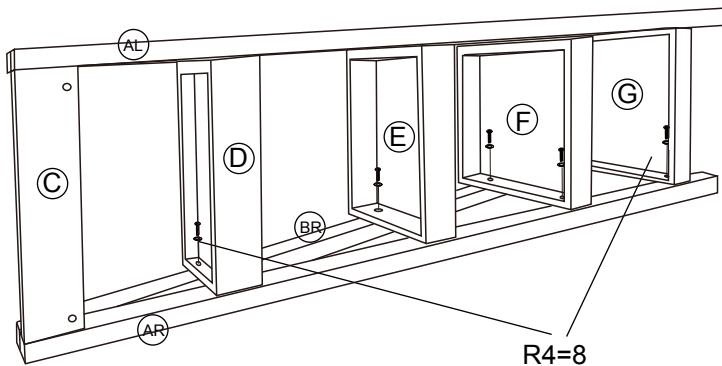

3.a) Fasten shelf D、E、F、G to leg AR & BR, using 8 flat head screw R4 (M6x25).

b) Fasten bar C to leg AR, using 1 flat head screw R2 (ST3.5X40) and 1 nut R3, then insert 1 plastic cap R1.

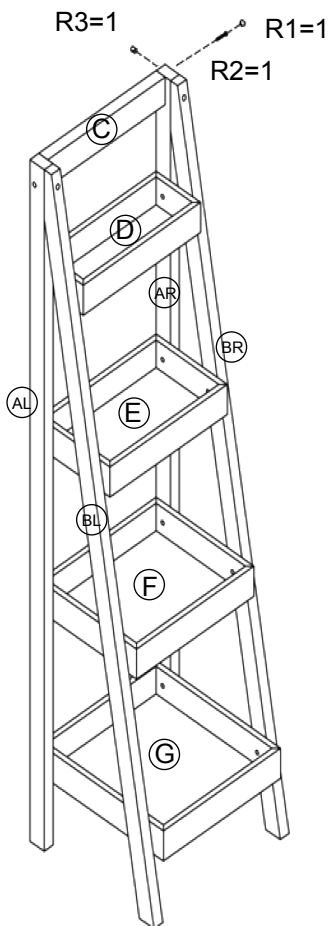

Care and Maintenance of your Furniture

- 1.Ensure metal plated hinges are kept dry to avoid rusting.
- 2.Please periodically check all fittings and re-tighten as necessary.
- 3.Wipe occasionally with a soft cloth slightly dampened with water.Then buff with a dry clean soft cloth.
- 4.Never allow any kind of liquid to remain on your furniture. Absorption can cause wood to warp or finishes to de-laminate.