

MEDICINE CABINET

Installation Guide

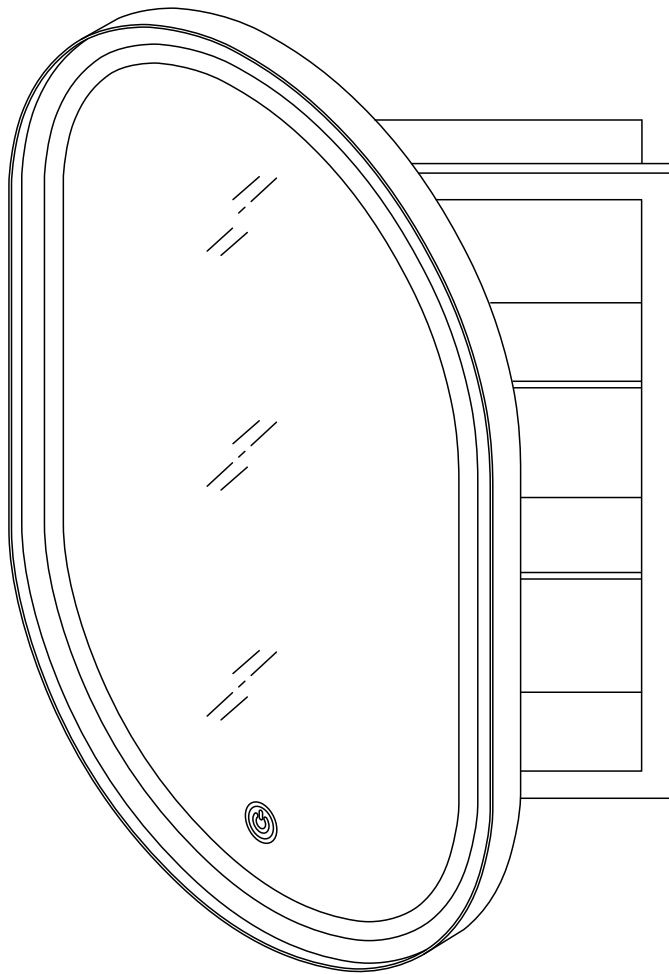

10FXJMC24002L-85

BEFORE STARTING

Before Using Product

- Read each step carefully before starting. It is very important that each step is performed in the correct order. If these steps are not followed in sequence, assembly difficulties will occur.
- Make sure all parts are included.
- Work in a spacious area and near where the unit will be used, preferably on a carpet, or use a piece of the cardboard packaging to protect your floor and product.
- For a smooth assembly process, we suggest you keep a lite tightness for all the screws during assembly. After the whole product is assembled, firmly tighten all the screws.

WARNING

- Do not allow children to climb on unit.
- Avoid sharp objects or corrosive chemicals to prevent damage to the product.
- During assembly, keep parts and packaging materials away from children and pets as there could be potential injury and choking hazards.
- Please make sure that all objects are removed before moving the assembled unit.
- The unit must be team lifted, not dragged or pushed. Failure to do so could cause instability, product collapse, and/or serious injury.
- Be careful when using power tools to assemble your furniture. Power tools may strip or damage the parts.

List of Parts

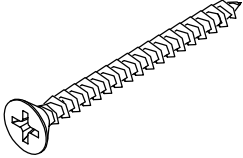
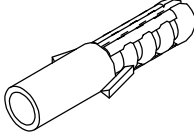
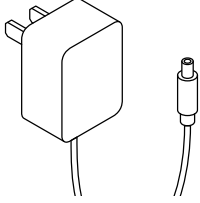
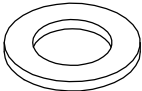
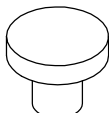
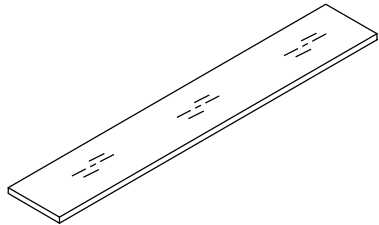
<p>A 11 pcs</p>  <p>M4*40mm Screws</p>	<p>B 11 pcs</p>  <p>M6*30mm Rubber plug screws</p>	<p>C 1 pc</p>  <p>Power cord plug</p>
<p>D 11 pcs</p>  <p>12mm Screw washers</p>	<p>E 8 pcs</p>  <p>9x9mm Rubber mat</p>	<p>F 2 pcs</p>  <p>394x82mm Glass shelf</p>

Please make sure all the parts are included.
Missing parts? Reach out to wf1_us@csbdhome.com for free replacement

Additional Tools Required

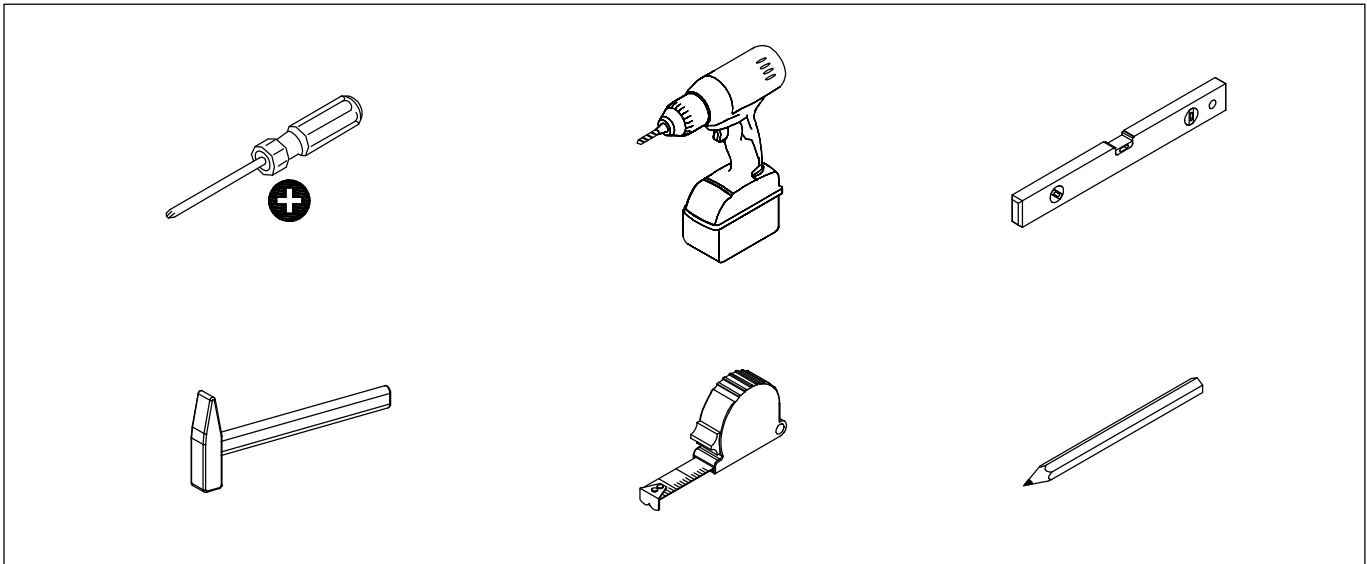

Rough Wall Opening

Overall Size	Rough Wall Opening
20.4in.(W) X 33.4in.(H) X 4.5 in.(D)	15.5in.(W) X 17.5in.(H) X 3.3 in.(D)

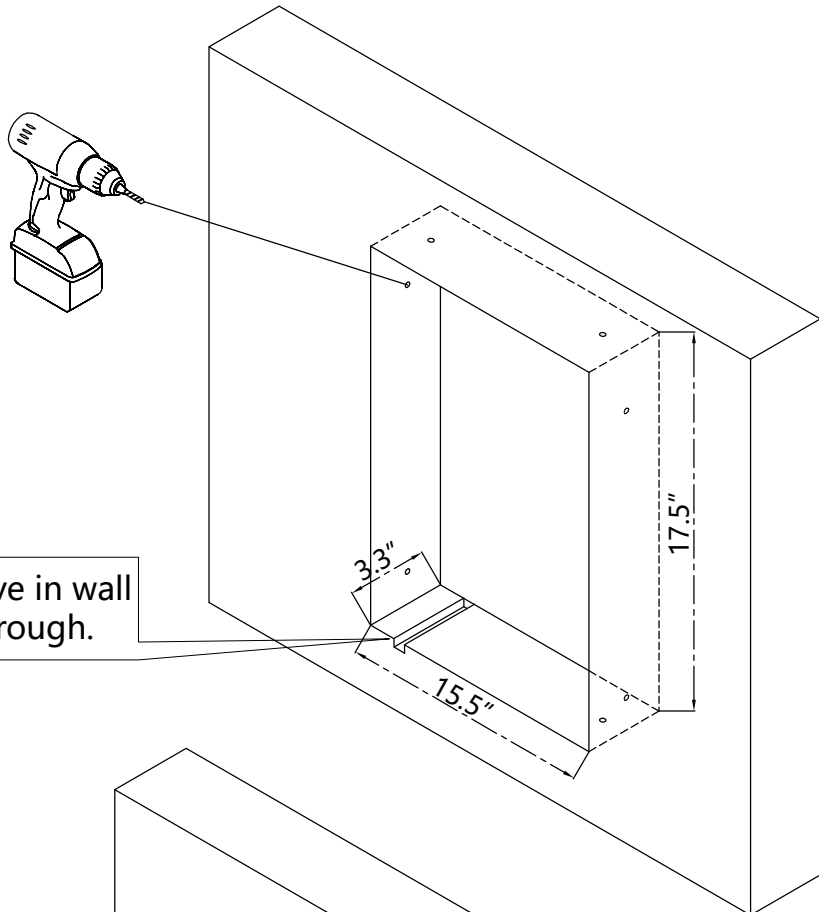

It need to open a groove in wall to let the power line through.

Mark seven(7) mounting holes on the wall corresponding to the pre-drilled hole locations in the mounting bars on the inside back panel of the cabinet.

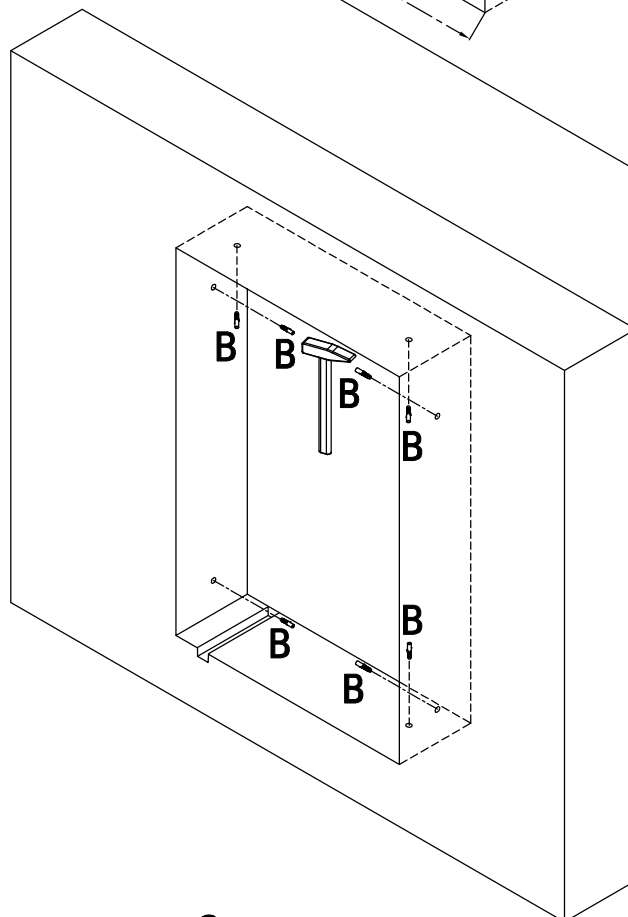

Surface installation

Mark four (4) mounting holes on the wall corresponding to the pre-drilled hole locations in the mounting bars on the inside back panel of the cabinet.

