

ASSEMBLY INSTRUCTIONS

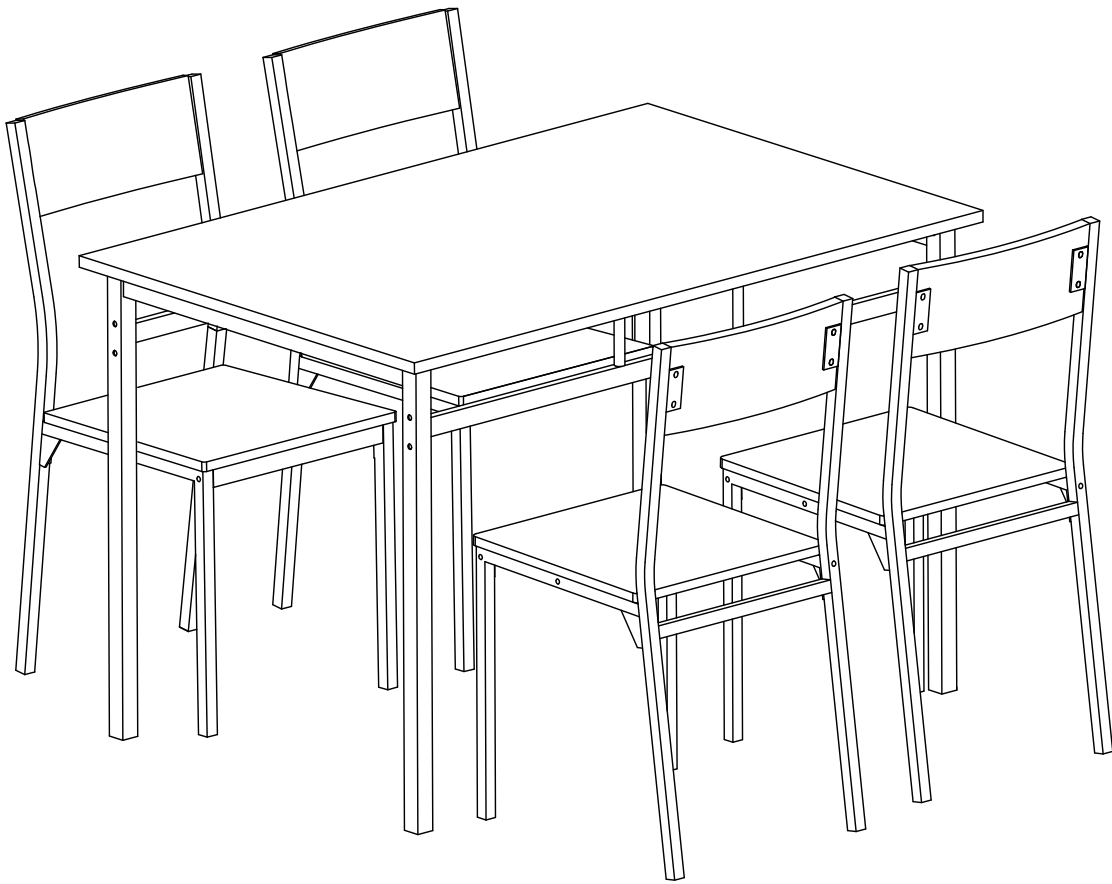

Dining Set

ASSEMBLY INSTRUCTIONS

ASSEMBLY TIPS:

1. Remove hardware from box and sort by size.
2. Please check to see that all hardware and parts are present prior to start of assembly.
3. Please follow attached instructions in the same sequence as numbered to assure fast & easy assembly.



WARNING!



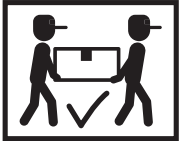





1. Don't attempt to repair or modify parts that are broken or defective. Please contact the store immediately.
2. This product is for home use only and not intended for commercial establishments.

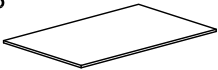



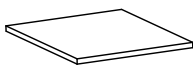

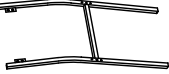
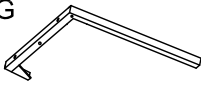
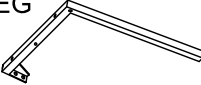
ASSEMBLY TIME

30 MINUTES

PARTS IDENTIFICATION

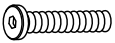
No	DESCRIPTION & FIGURE	QTY
A	TABLE TOP 	1pc
B	TABLE LEG 	2pcs
C	TABLE TOP APRON 	2pcs
D	TABLE TOP SUPPORT 	4pcs
E	CHAIR SEAT 	4pcs
F	CHAIR BACK 	4pcs
G	CHAIR BACK LEG 	4pcs
H	CHAIR LEFT LEG 	4pcs
I	CHAIR RIGHT LEG 	4pcs
J	CHAIR FRONT STRETCHER 	4pcs
K	CHAIR MIDDLE STRETCHER 	4pcs

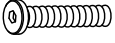
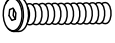
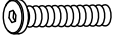
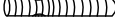
HARDWARE PACKAGE:

No	DESCRIPTION	FIGURE	QTY
1	BOLT (longest)	 M6×60mm	4pcs
2	BOLT (longer)	 M6×50mm	4pcs
3	BOLT (long)	 M6×35mm	8pcs
4	BOLT (short)	 M6×30mm	40pcs
5	BOLT (shorter)	 M6×12mm	40pcs
6	STUD	 M6×30mm	4pcs
7	NUT	 M6×17mm	8pcs
8	ALLEN KEY (4mm)		2pcs

STEP 1

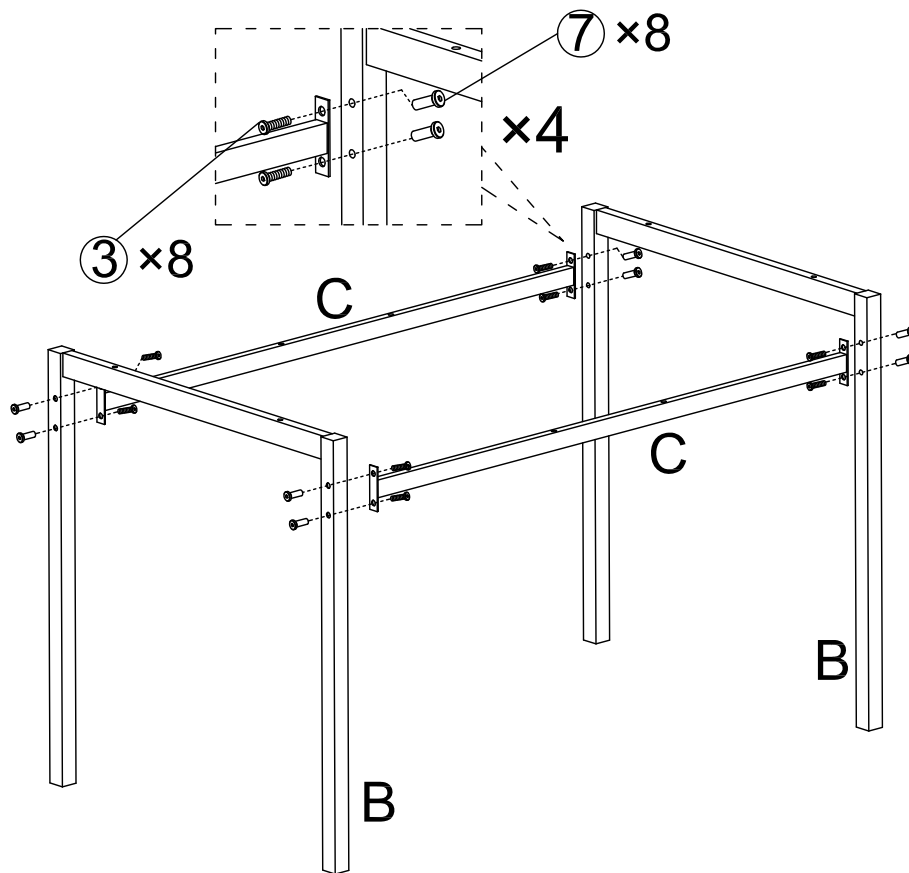

STEP 2

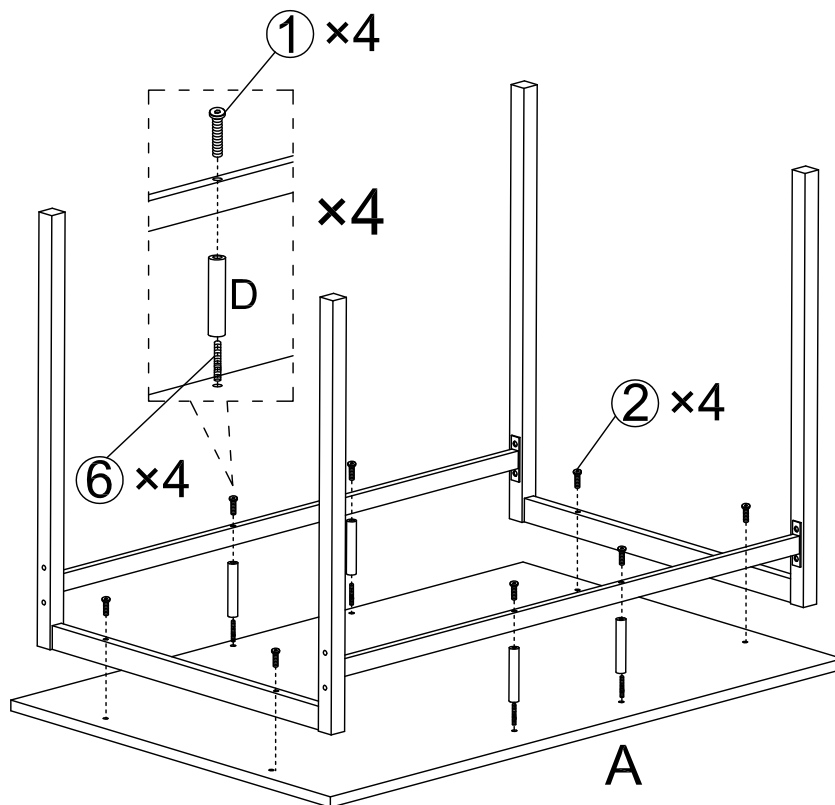

STEP 3

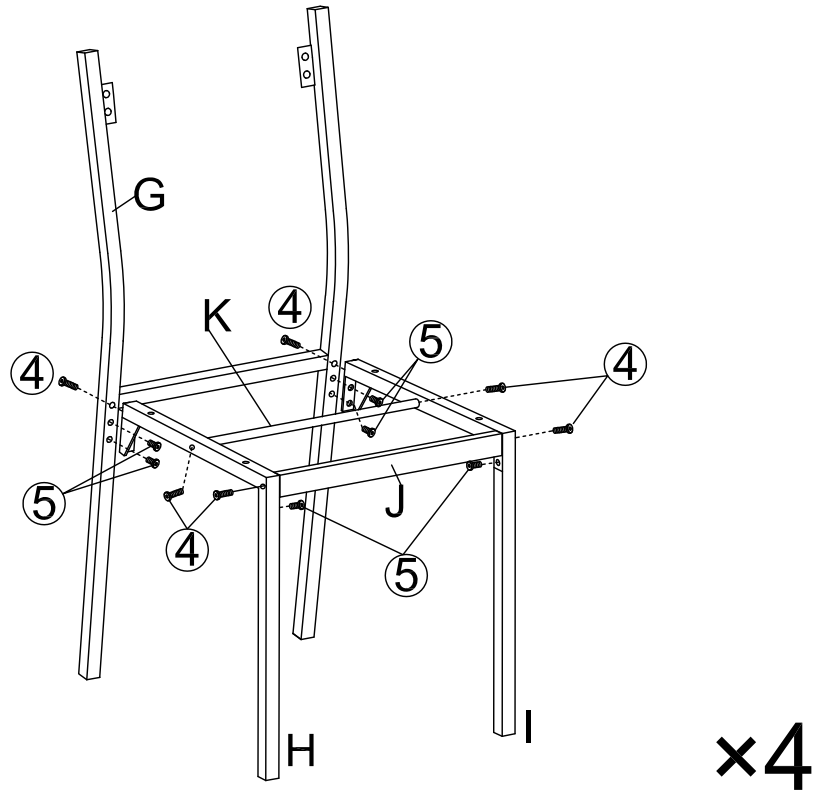

STEP 4

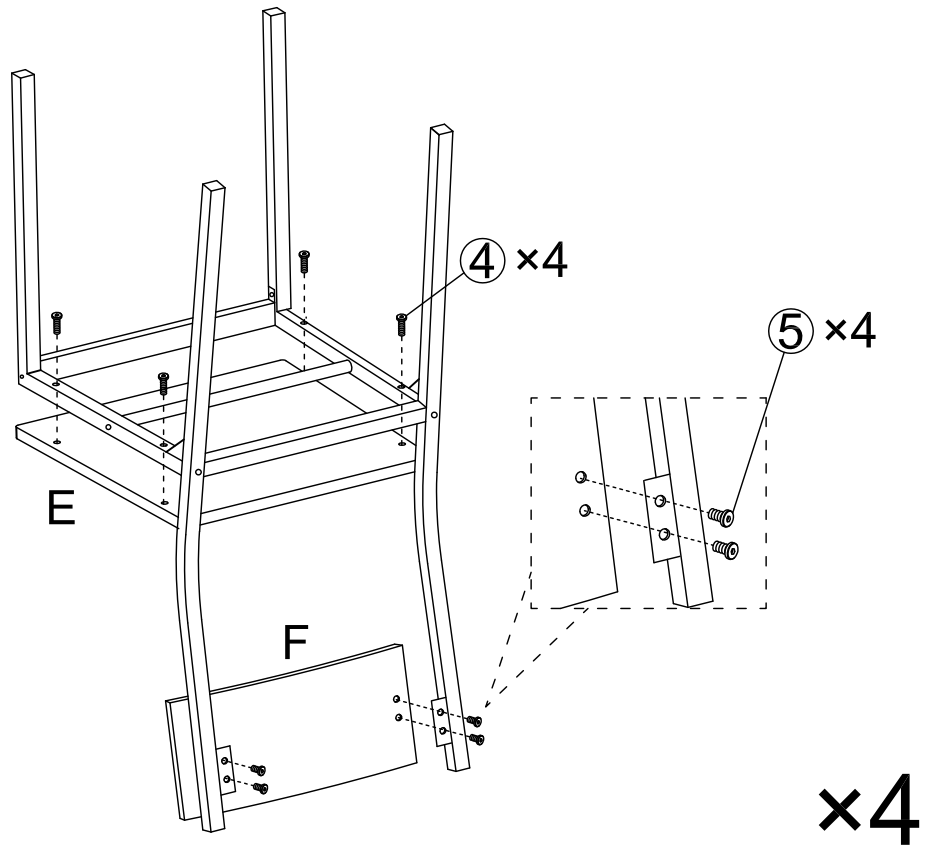

STEP 5
COMPLETE

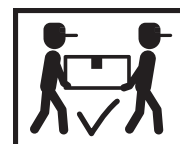
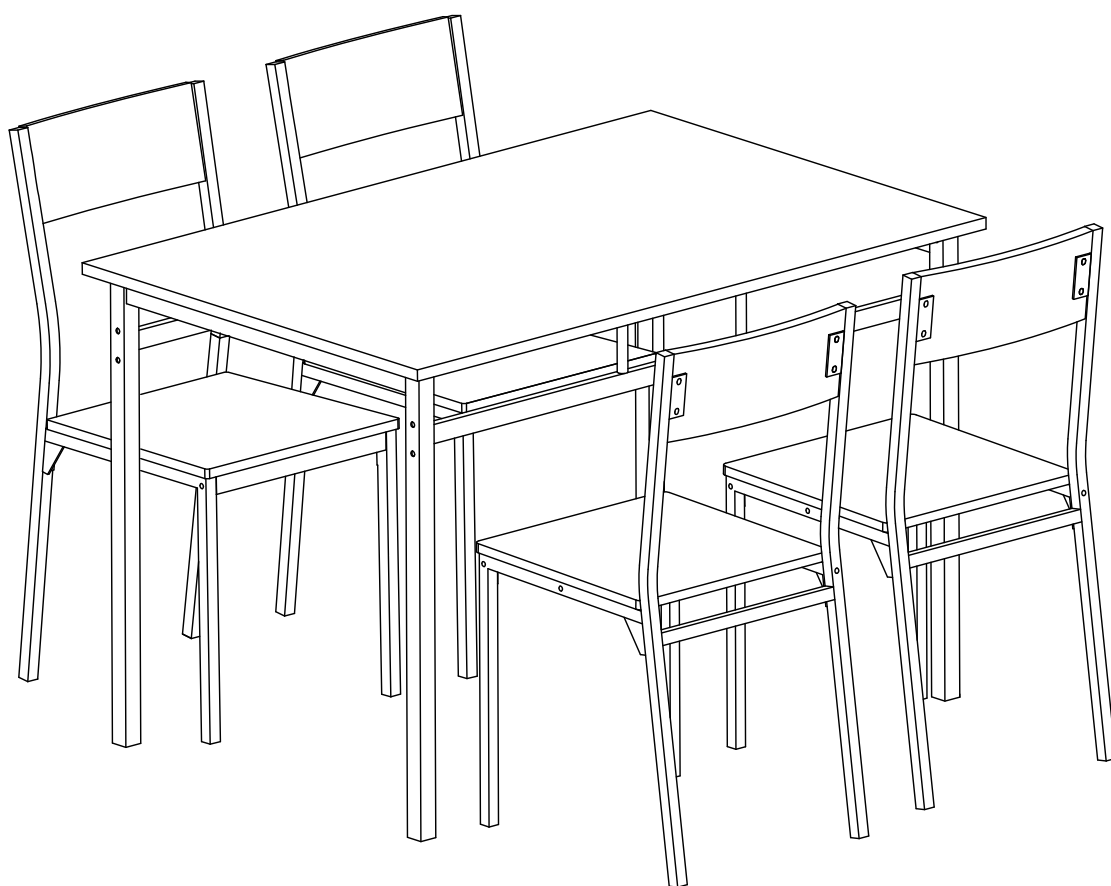

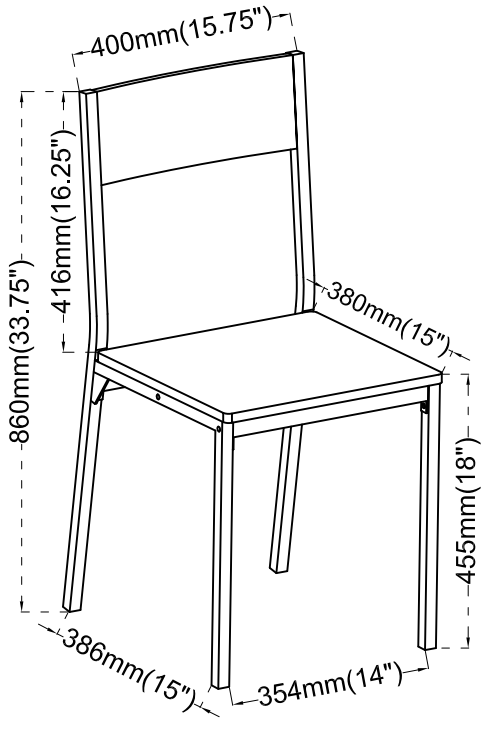
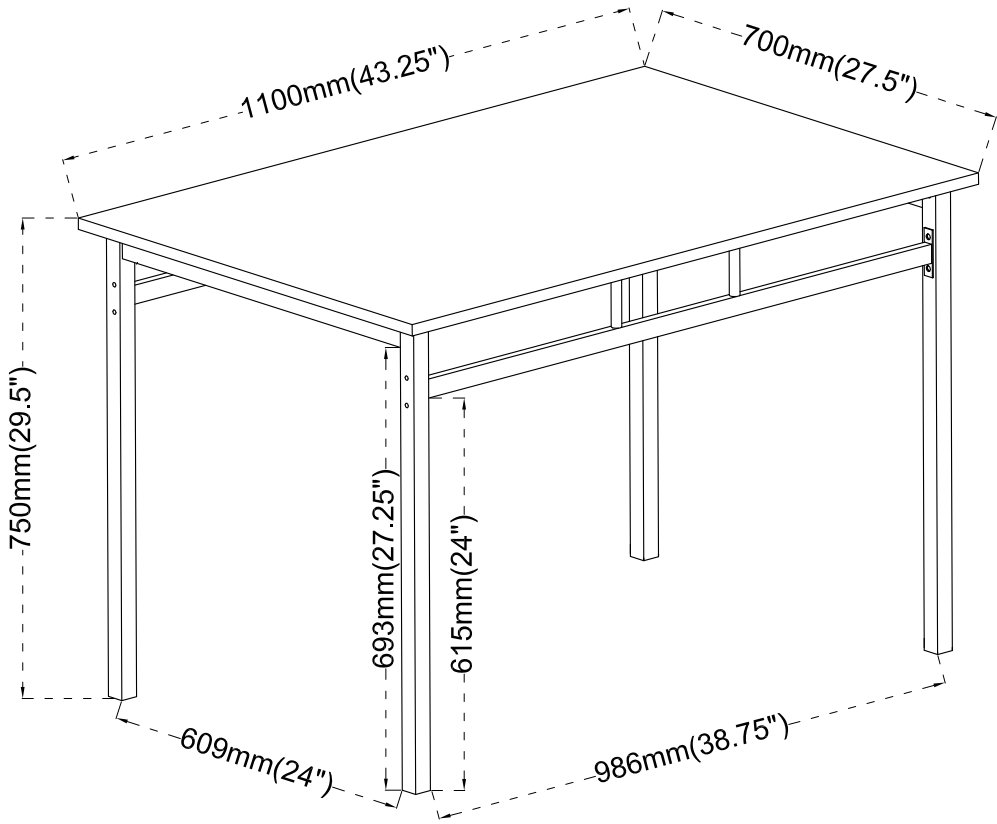

Note: Dimension tolerance $\pm 5\%$