

N606P375254

N606P375255

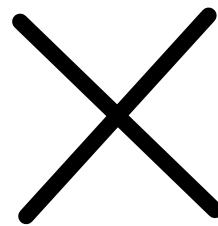
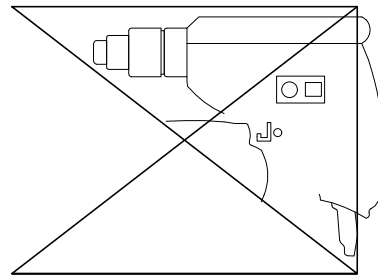
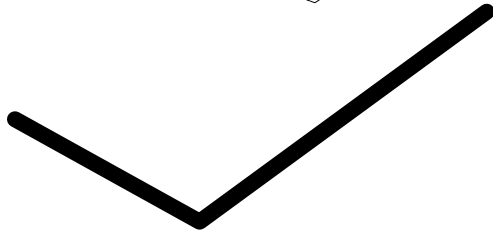
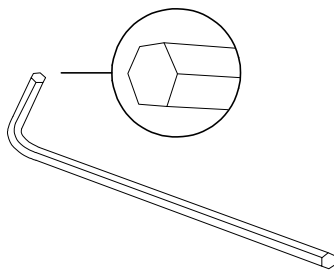

(DE): Verwenden Sie beim Anbringen der Tischplatte keinen Bohrer! Bitte verwenden Sie die im Paket enthaltenen Werkzeuge.

(UK): Do not use an electric drill when installing the desktop! Please use the tools provided in the package.

(FR): Ne pas utiliser de perceuse électrique lors de l'installation du plateau de table ! Veuillez utiliser les outils fournis dans l'emballage.

(IT): Non utilizzare un trapano elettrico durante l'installazione del piano del tavolo! Si prega di utilizzare gli strumenti forniti nella confezione.

(ES): ¡No utilice un taladro eléctrico al instalar el escritorio! Por favor, use las herramientas incluidas en el paquete.

(NL): Gebruik geen elektrische boormachine bij het monteren van het tafelblad! Gebruik de meegeleverde gereedschappen uit de verpakking.

(SE): Använd inte en elektrisk bormaskin vid montering av bordsskivan! Använd de verktyg som medföljer i förpackningen.

(PL): Nie używaj wiertarki elektrycznej podczas montażu blatu! Użyj narzędzi dołączonych do opakowania.



DE

Warnung

- 1 Die maximale Tragfähigkeit des Produkts beträgt Tisch 30 kg, Stuhl 80 kg.
- 2 Kinder dürfen nicht auf Möbel klettern, da dies zu Kippen und schweren Verletzungen führen kann.
- 3 Um die Sicherheit zu gewährleisten, installieren Sie bitte gemäß den Anweisungen korrekt und holen Sie bei Bedarf professionelle Hilfe ein.
- 4 Stellen Sie Möbel nicht in der Nähe von Wärmequellen oder heißen Gegenständen auf, um Brandgefahr zu vermeiden.
- 5 Vermeiden Sie es, Möbel in feuchten Umgebungen zu platzieren, um Materialschäden zu vermeiden.
- 6 Überprüfen Sie regelmäßig alle Verbindungsstücke und Befestigungen, um sicherzustellen, dass sie fest sitzen und unerwartete Unfälle zu verhindern.
- 7 Reinigen Sie Möbel mit einem feuchten Tuch oder Alkohol, vermeiden Sie die Verwendung von Reinigungsmitteln, die ätzende Chemikalien enthalten.

UK

Warning

- 1 The maximum load capacity of the product is table 30 kg, chair 80 kg.
- 2 Children should not climb on furniture, as this may cause tipping and serious injuries.
- 3 To ensure safety, please install according to the instructions correctly, and seek professional assistance if necessary.
- 4 Do not place furniture near heat sources or hot items to avoid the risk of fire.
- 5 Do not place furniture in damp environments to prevent material damage.
- 6 Regularly check all connections and fasteners to ensure they are secure to prevent accidents.
- 7 Clean furniture with a damp cloth or alcohol, avoid using cleaning agents containing corrosive chemicals.

FR

Avertissement

- 1 La capacité de charge maximale du produit est de 30 kg pour la table et de 80 kg pour la chaise.
- 2 Les enfants ne doivent pas grimper sur les meubles, car cela peut entraîner un renversement et des blessures graves.
- 3 Pour assurer la sécurité, veuillez installer correctement selon les instructions et demander une assistance professionnelle si nécessaire.
- 4 Ne placez pas les meubles près de sources de chaleur ou d'objets chauds pour éviter les risques d'incendie.
- 5 Évitez de placer les meubles dans des environnements humides pour éviter les dommages aux matériaux.
- 6 Vérifiez régulièrement toutes les connexions et les fixations pour vous assurer qu'elles sont sécurisées et prévenir les accidents.
- 7 Nettoyez les meubles avec un chiffon humide ou de l'alcool, évitez d'utiliser des agents de nettoyage contenant des produits chimiques corrosifs.

IT

Avviso

1 La portata massima del prodotto è di 30 kg per il tavolo e 80 kg per la sedia.

2 I bambini non devono arrampicarsi sui mobili, poiché ciò potrebbe causare il ribaltamento e gravi lesioni.

3 Per garantire la sicurezza, installare correttamente secondo le istruzioni e chiedere assistenza professionale se necessario.

4 Non posizionare i mobili vicino a fonti di calore o oggetti caldi per evitare il rischio di incendio.

5 Evitare di posizionare i mobili in ambienti umidi per evitare danni ai materiali.

6 Controllare regolarmente tutte le connessioni e i fissaggi per assicurarsi che siano sicuri e prevenire gli incidenti.

7 Pulire i mobili con un panno umido o alcool, evitare l'uso di agenti di pulizia contenenti sostanze chimiche corrosive.

ES

Aviso

1 La capacidad de carga máxima del producto es de 30 kg para la mesa y 80 kg para la silla.

2 Los niños no deben trepar sobre los muebles, ya que esto puede causar que se vuelquen y provocar lesiones graves.

3 Para garantizar la seguridad, instale correctamente según las instrucciones y busque asistencia profesional si es necesario.

4 No coloque los muebles cerca de fuentes de calor o objetos calientes para evitar el riesgo de incendio.

5 Evite colocar los muebles en entornos húmedos para evitar daños en los materiales.

6 Revise regularmente todas las conexiones y sujeciones para asegurarse de que estén seguras y prevenir accidentes.

7 Limpie los muebles con un paño húmedo o alcohol, evite el uso de agentes de limpieza que contengan productos químicos corrosivos.

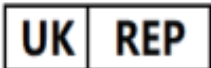
Importer	COMHARBOR LIMITED
Address	Unit C, Swift Point, Cosford Lane, Rugby, CV21 1PY, GB
Email	harborcomhar@gmail.com
Manufacturer	CHANGZHOU SU SHI HOME FURNISHING CO LTD
Add.	NO.10,SUQIAN ROAD,HENGLIN TOWN,WU JIN DISTRICT,CHANGZHOU 213000 CHINA
Email/URL	SU13775053361@126.COM
Product identification	C335SSJ20250828GC
Made in	CHINA
	COMHARBOR LIMITED Unit C, Swift Point, Cosford Lane, Rugby, CV21 1PY, GB harborcomhar@gmail.com

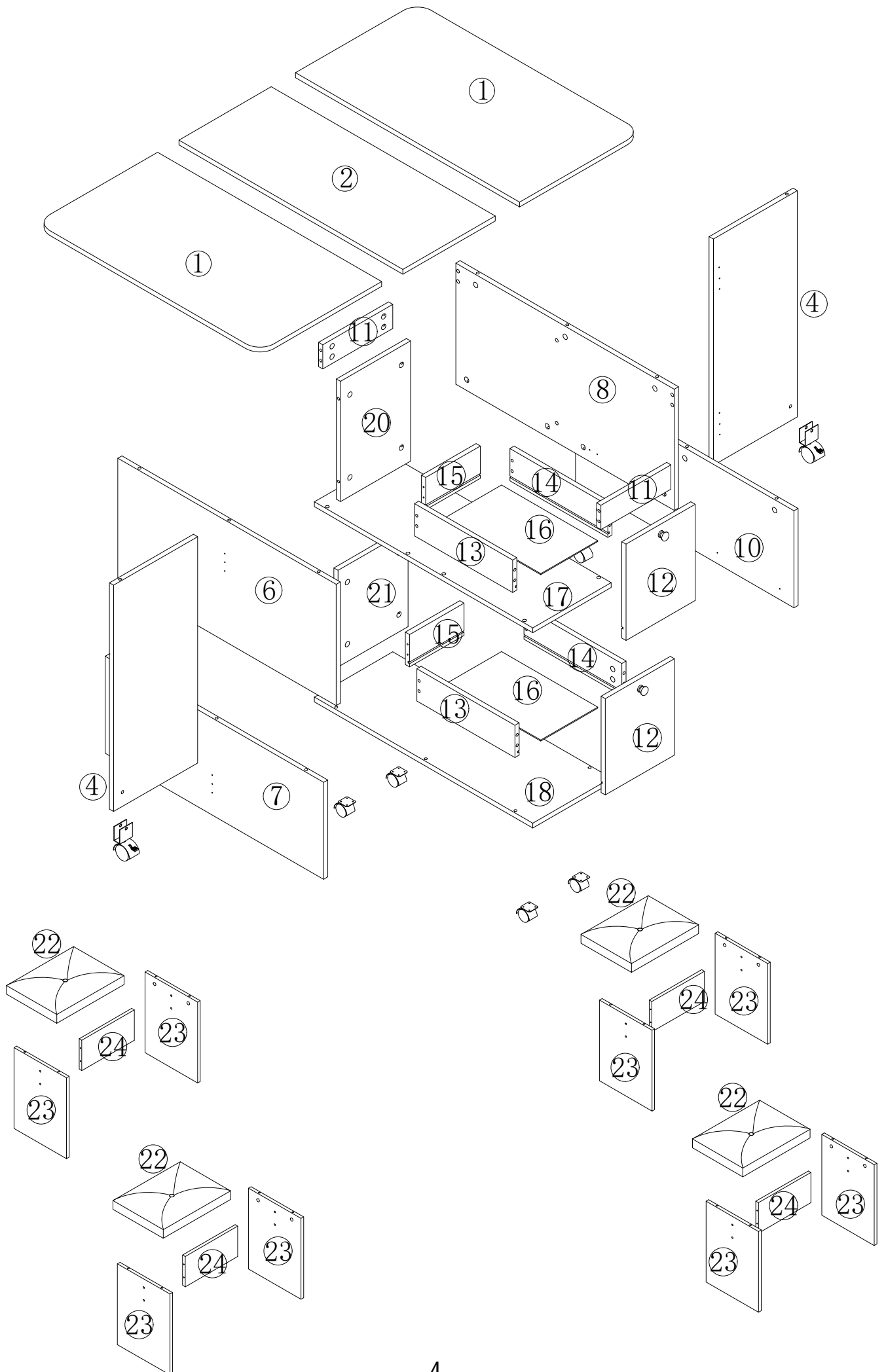

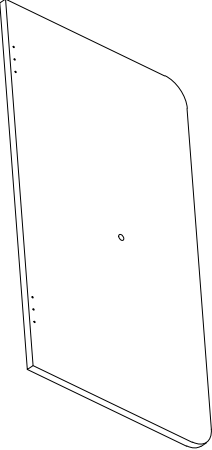
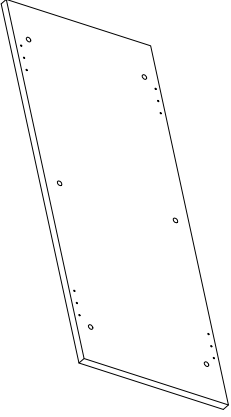
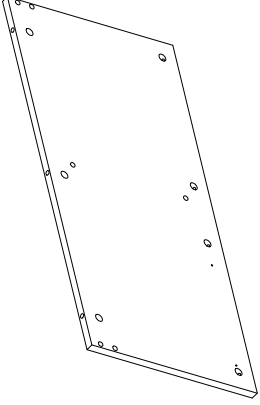
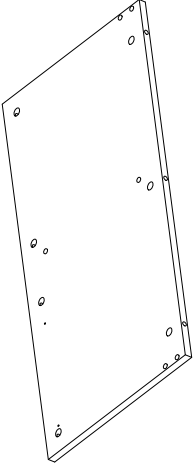
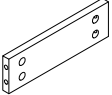
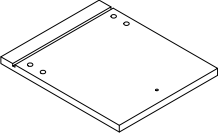
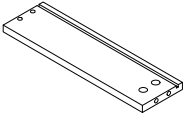
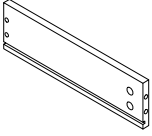
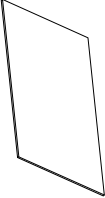
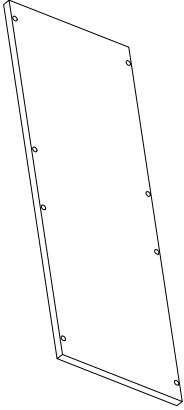
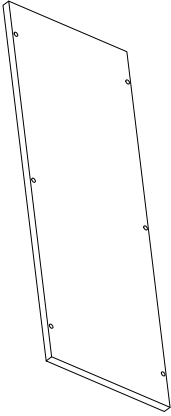
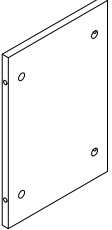



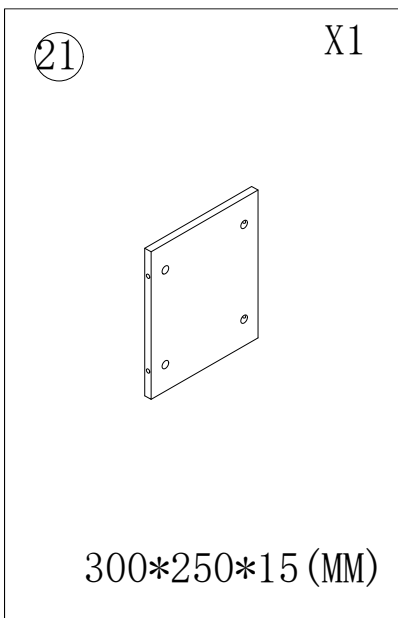



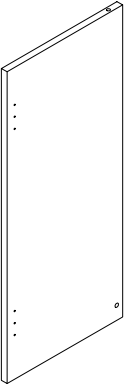
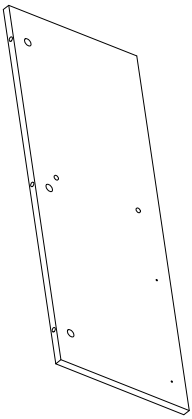
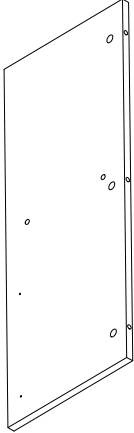

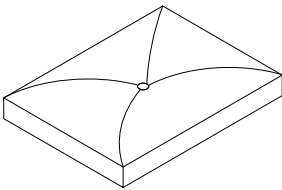
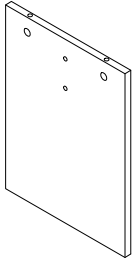
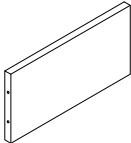
<p>① X2</p>  <p>800*435*15 (MM)</p>	<p>② X1</p>  <p>800*330*15 (MM)</p>	<p>⑥ X1</p>  <p>780*375*15 (MM)</p>	<p>⑧ X1</p>  <p>780*375*15 (MM)</p>
<p>⑪ X2</p>  <p>250*75*15 (MM)</p>	<p>⑫ X2</p>  <p>298*247*15 (MM)</p>	<p>⑬ X2</p>  <p>350*100*15 (MM)</p>	<p>⑭ X2</p>  <p>350*100*15 (MM)</p>
<p>⑯ X2</p>  <p>344*204*3 (MM)</p>	<p>⑰ X1</p>  <p>780*280*15 (MM)</p>	<p>⑱ X1</p>  <p>780*280*15 (MM)</p>	<p>⑳ X1</p>  <p>372*250*15 (MM)</p>

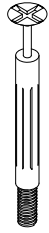
BOX-1/2 N606P375254

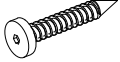
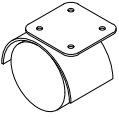

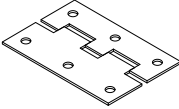

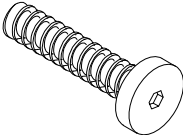
BOX-2/2 N606P375255

<p>④ X2</p>  <p>700*300*15 (MM)</p>	<p>⑦ X1</p>  <p>780*300*15 (MM)</p>	<p>⑩ X1</p>  <p>780*300*15 (MM)</p>	<p>⑮ X2</p>  <p>195*100*15 (MM)</p>
<p>⑳ X4</p>  <p>400*300*40 (MM)</p>	<p>㉓ X8</p>  <p>400*290*15 (MM)</p>	<p>㉔ X4</p>  <p>300*150*15 (MM)</p>	

<p>(A)</p>  <p>M15 60PCS</p>	<p>(B)</p>  <p>φ 15 60PCS</p>	<p>(C)</p>  <p>M3.5*14 80PCS</p>	<p>(D)</p>  <p>M5*40 30PCS</p>
<p>(E)</p>  <p>2PCS</p>	<p>(F)</p>  <p>2PCS</p>	<p>(G)</p>  <p>8PCS</p>	<p>(H)</p>  <p>M4*22 2PCS</p>
<p>(J)</p>  <p>2PCS</p>	<p>(K)</p>  <p>M6*23 2PCS</p>	<p>(L)</p>  <p>2PCS</p>	<p>(M)</p>  <p>2PCS</p>

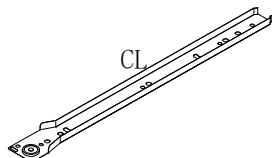
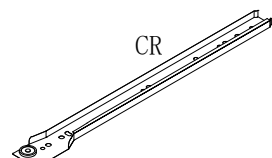
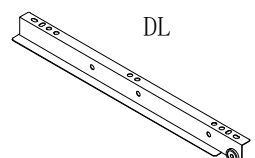
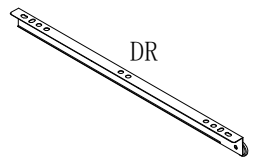
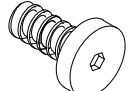
BOX-1/2 N606P375254

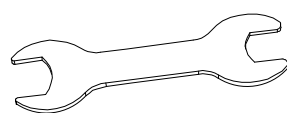
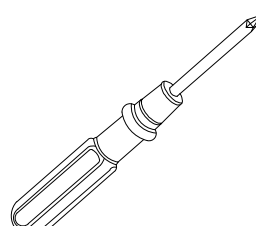
<p>ⓐ</p>  <p>CL</p> <p>2PCS</p>	<p>ⓑ</p>  <p>CR</p> <p>2PCS</p>	<p>Ⓒ</p>  <p>DL</p> <p>2PCS</p>	<p>Ⓓ</p>  <p>DR</p> <p>2PCS</p>
<p>Ⓝ</p>  <p>M6*12</p> <p>2PCS</p>			

Step 1

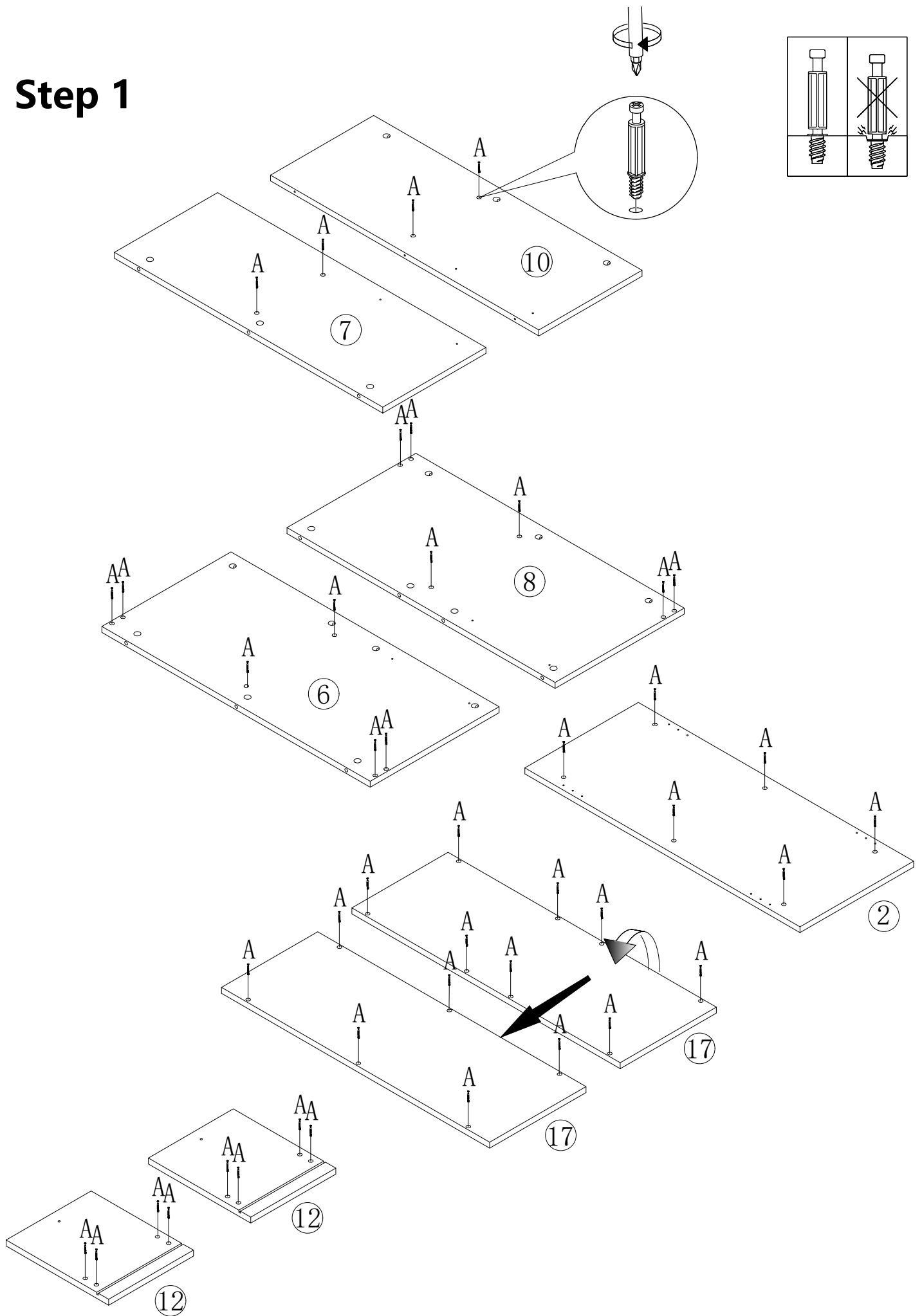

A  X44

Step 2

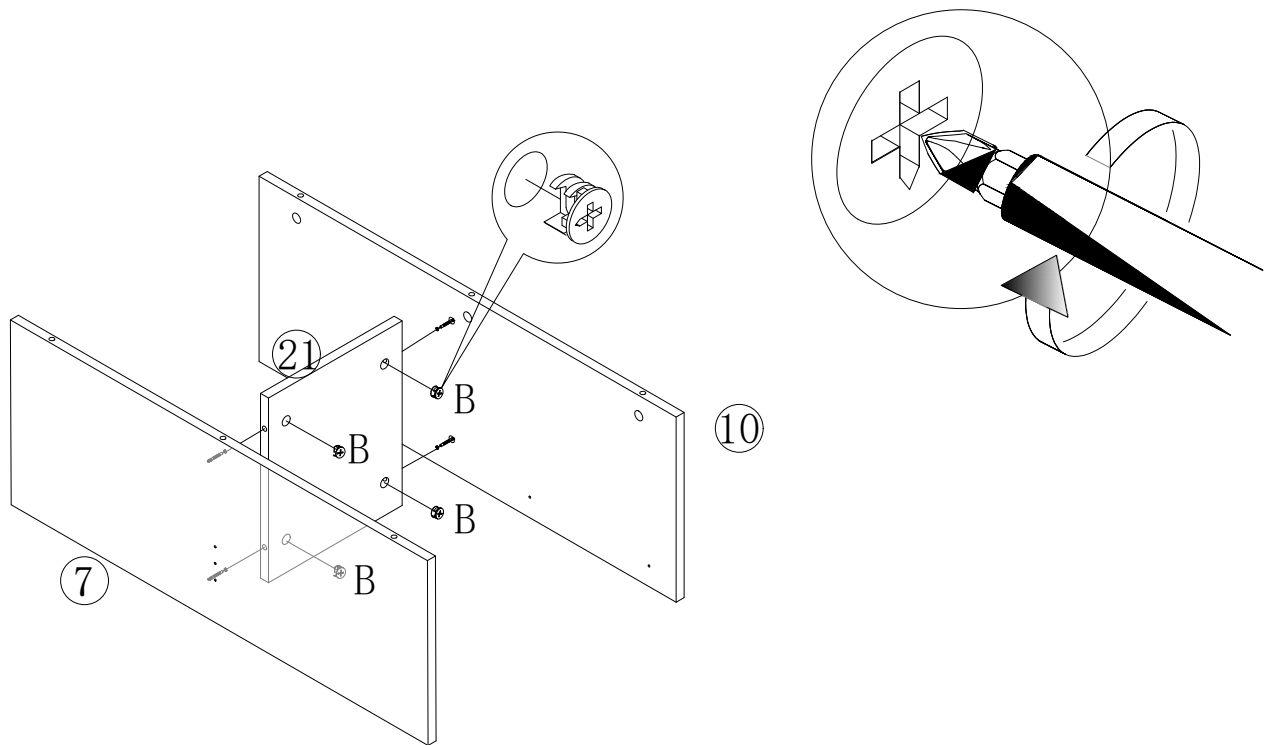

B  X4

Step 3

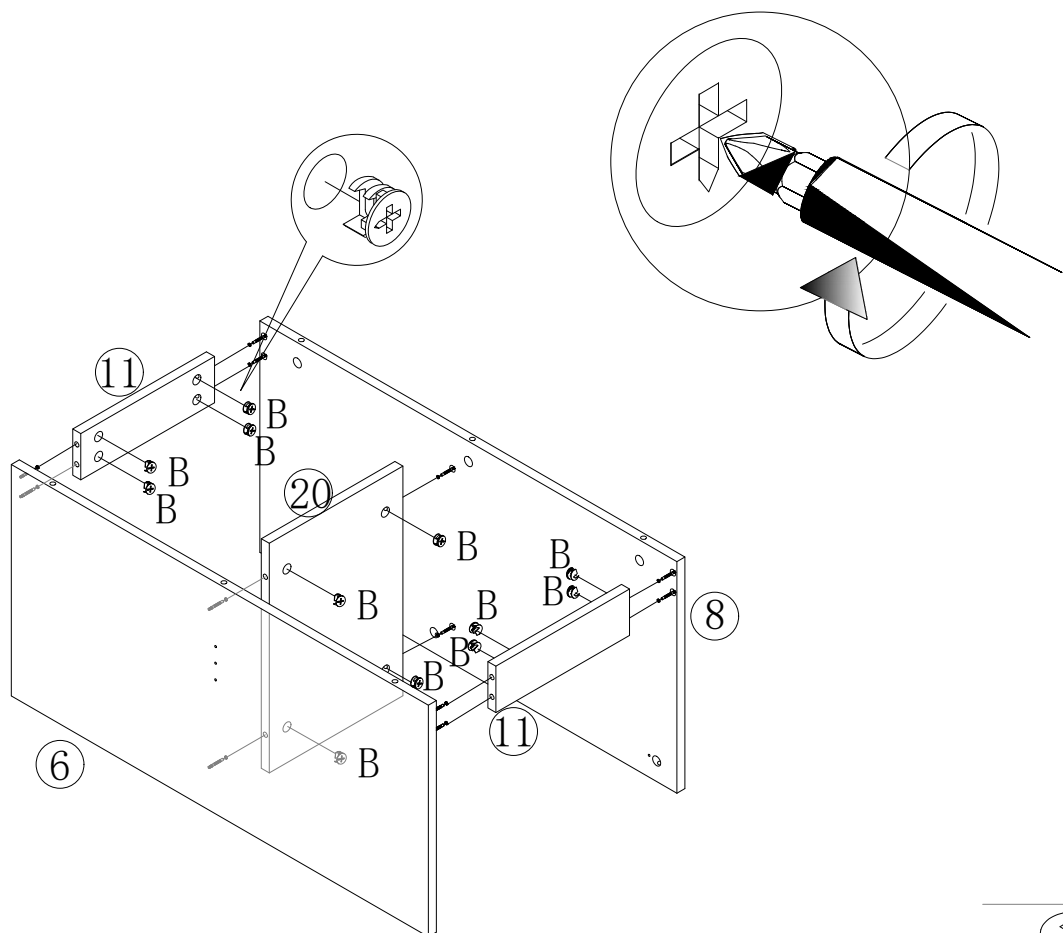

B  X12

Step 4

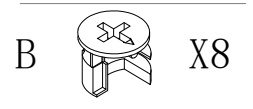
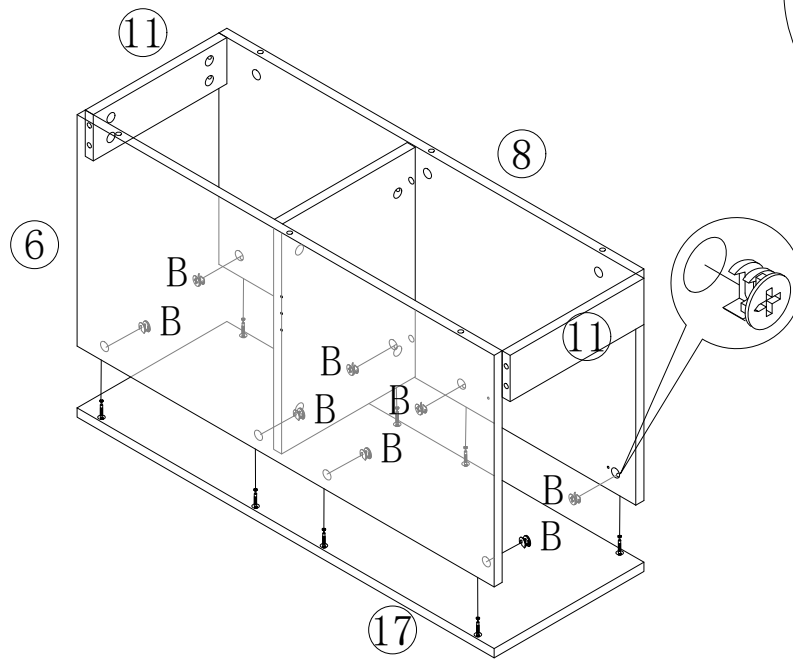

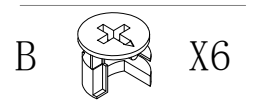
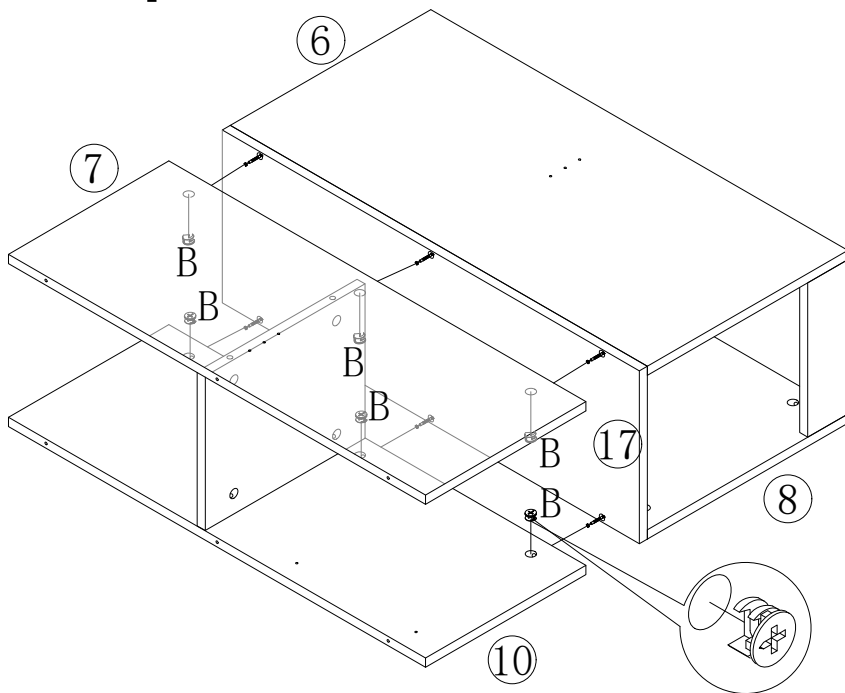

Step 5



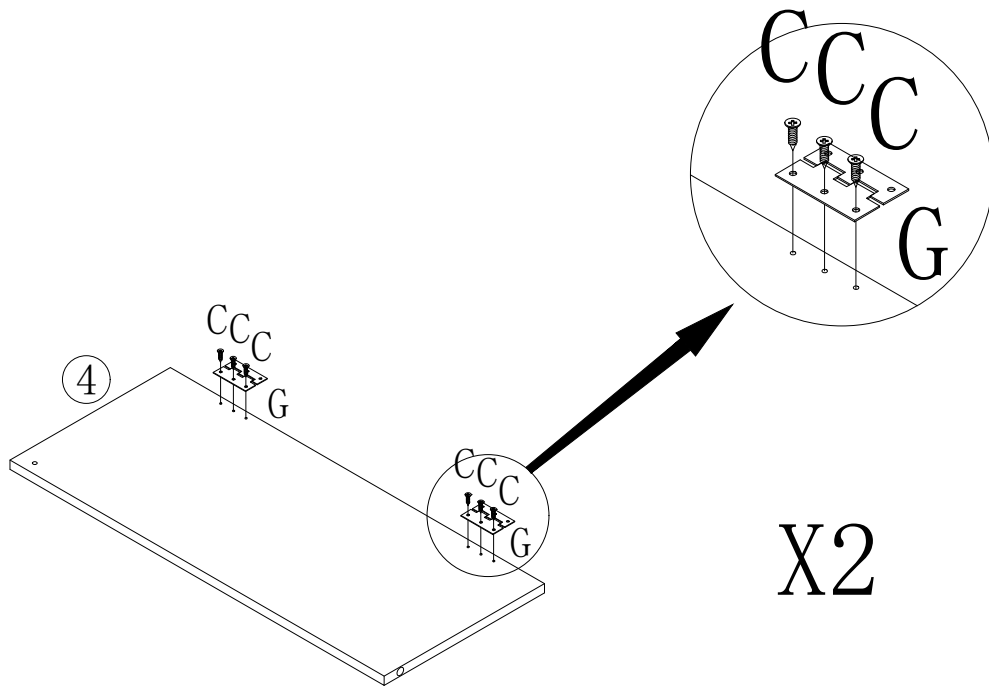



Step 8

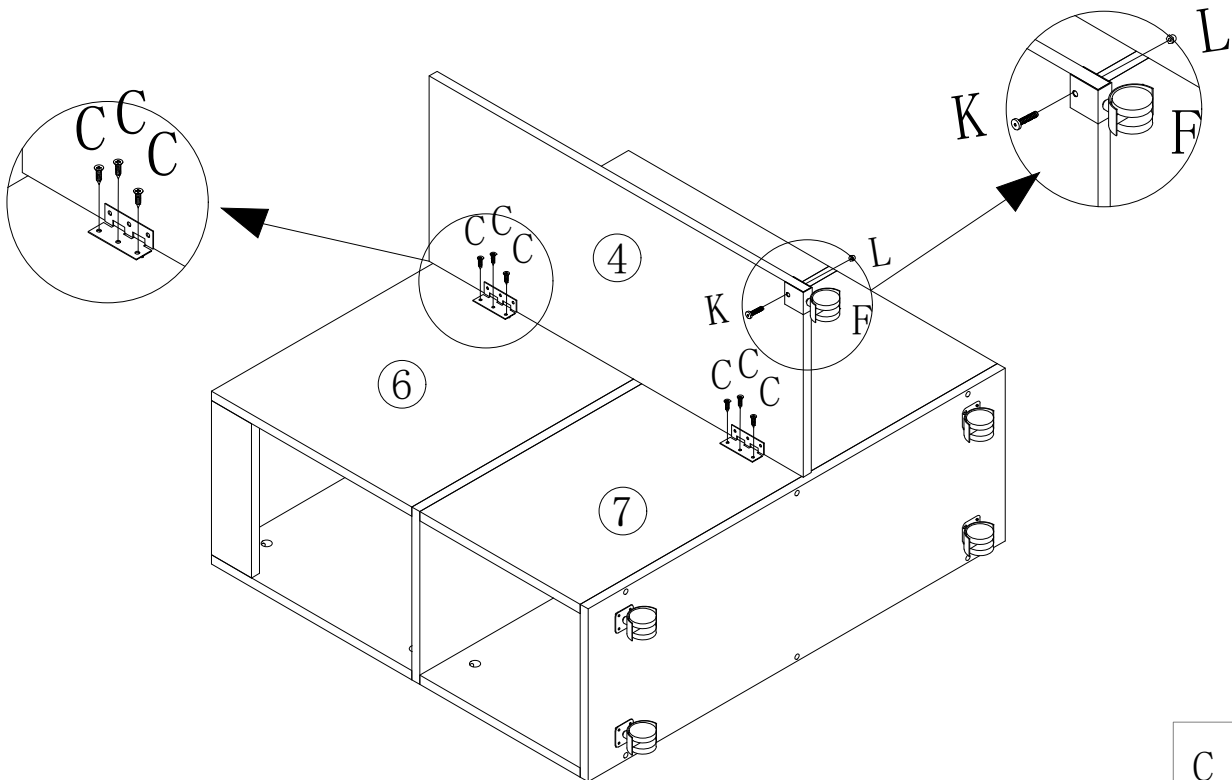

C		X12
G		X4

Step 9



C		X6
F		X1
K		X1
L		X1

Step 10

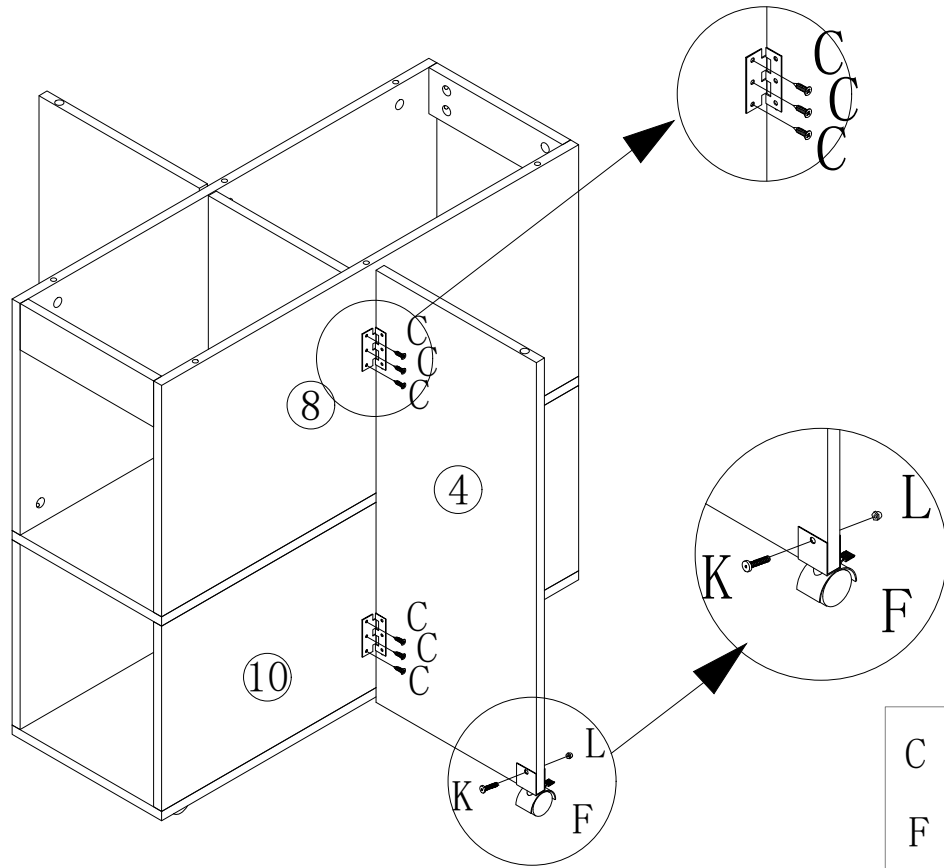

C		X6
F		X1
K		X1
L		X1

Step 11

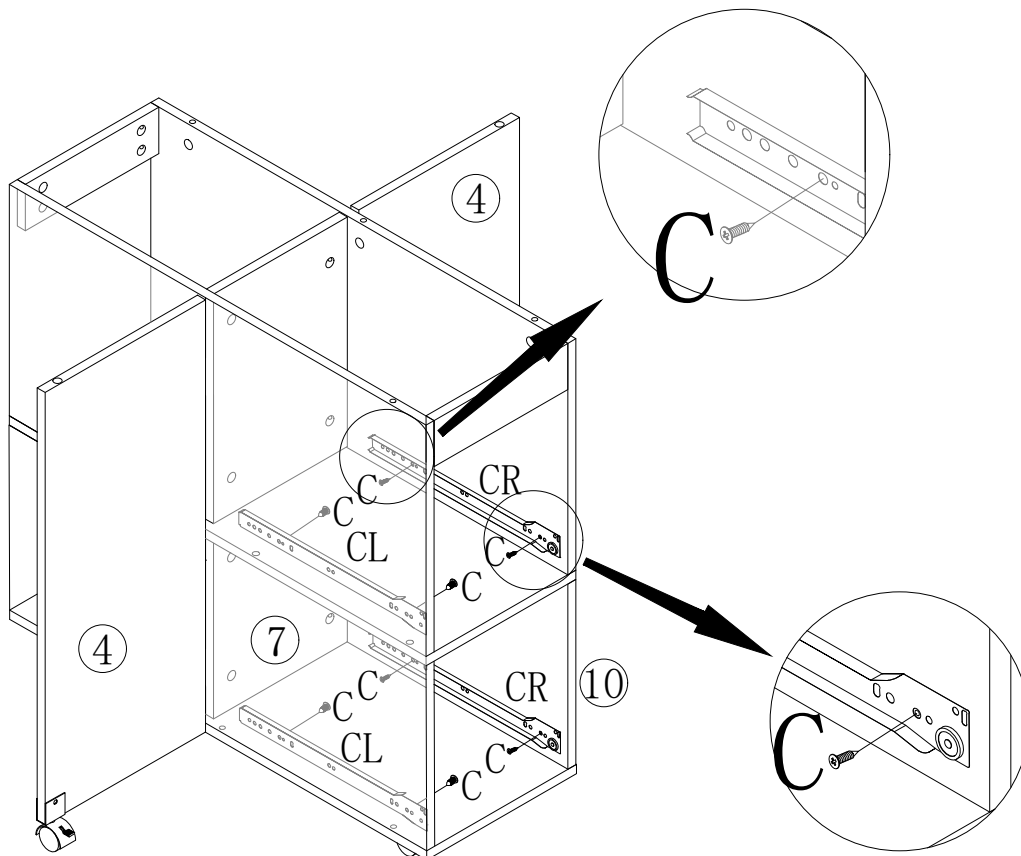

CR		X2
CL		X2
C		X8

Step 12

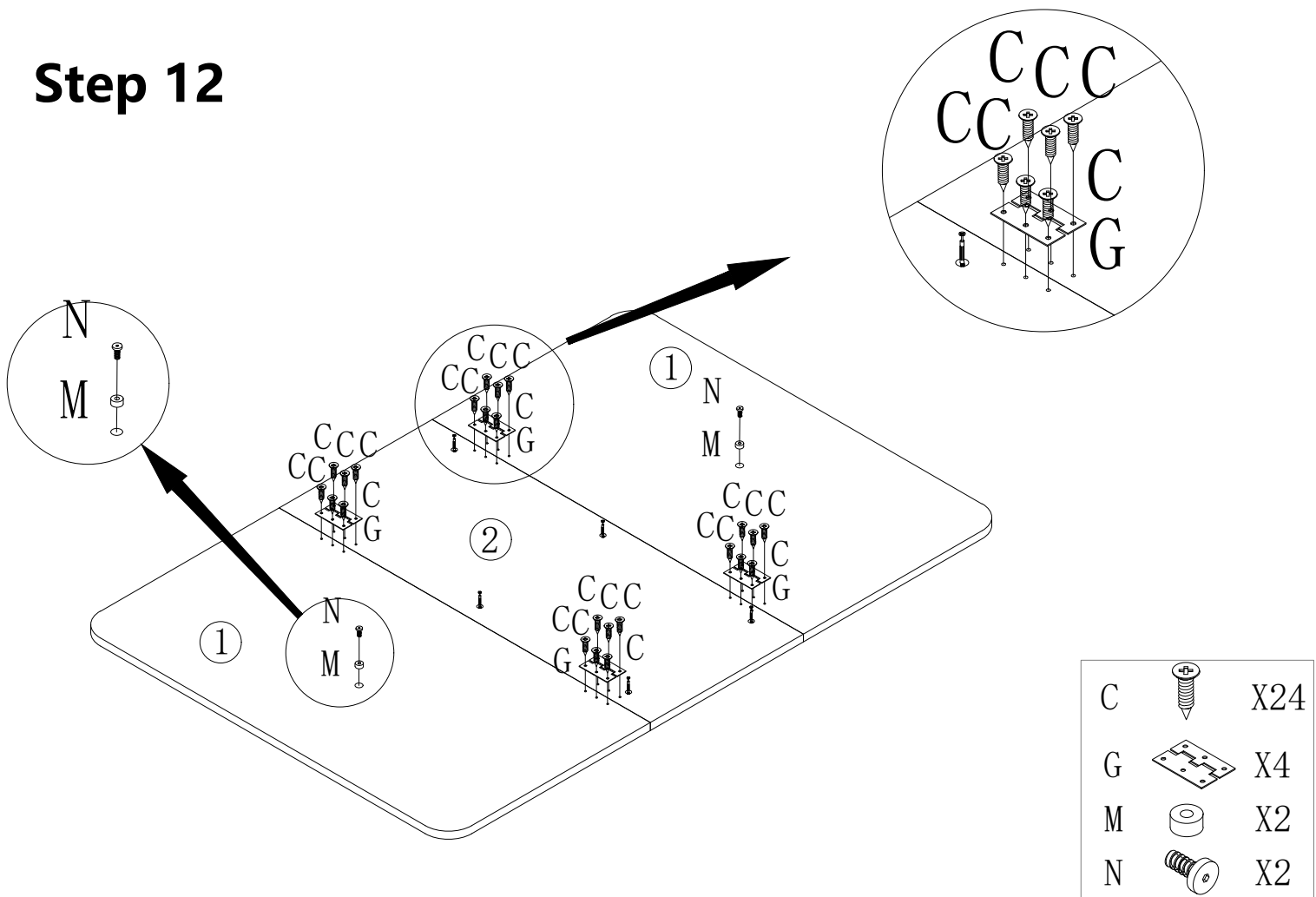

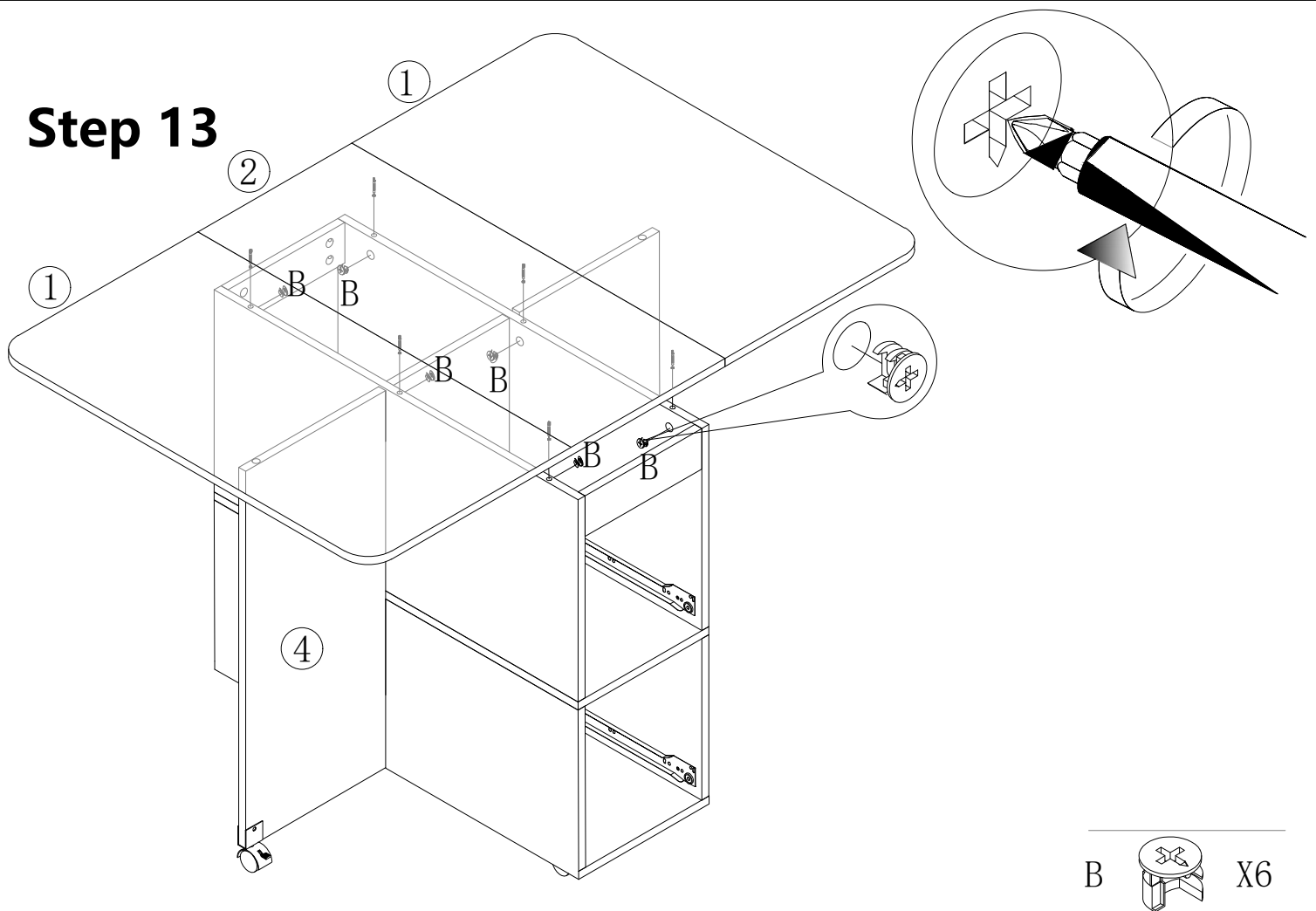

Step 13

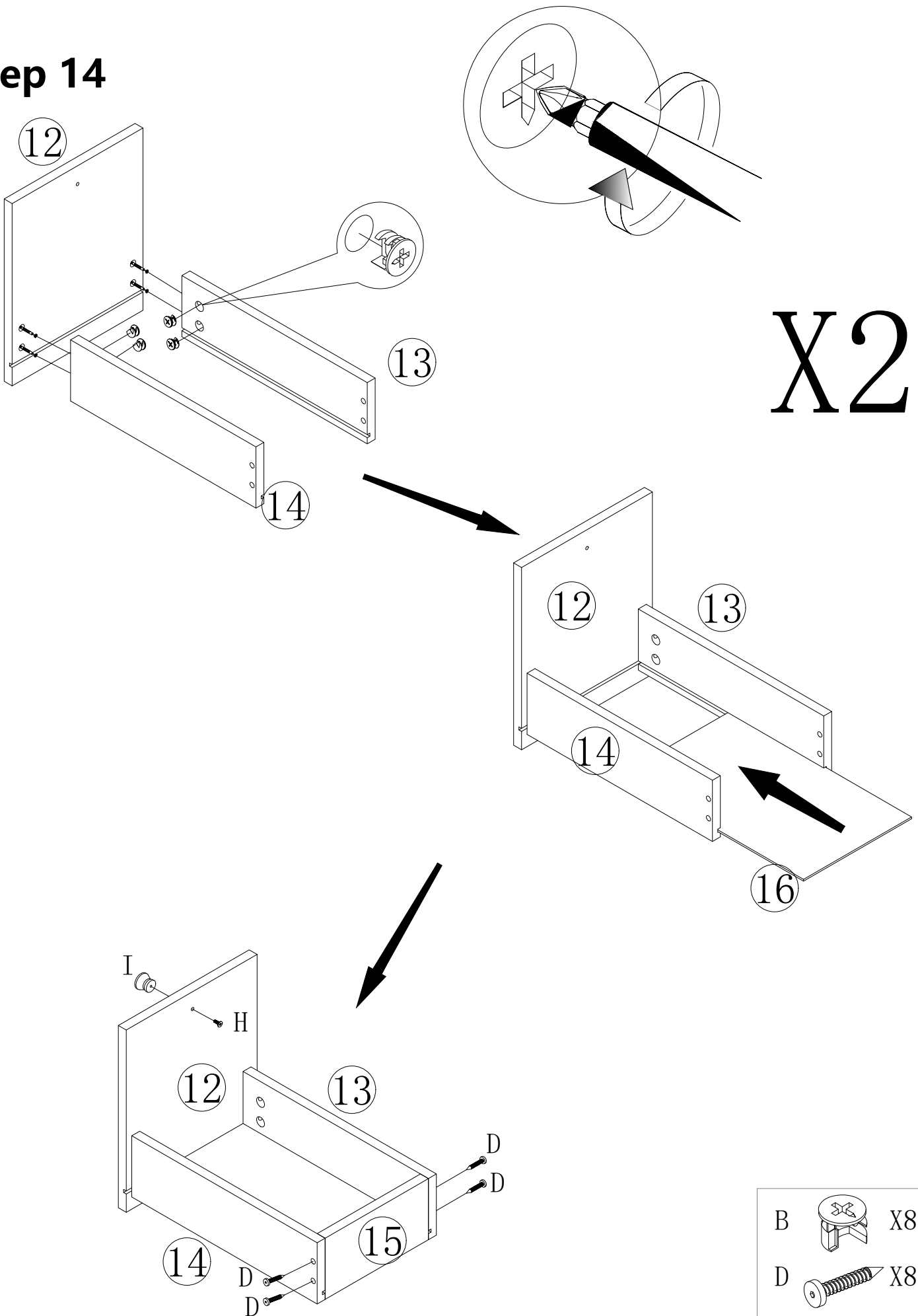

Step 14

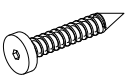

X2

B		X8
D		X8
H		X2
I		X2

Step 15

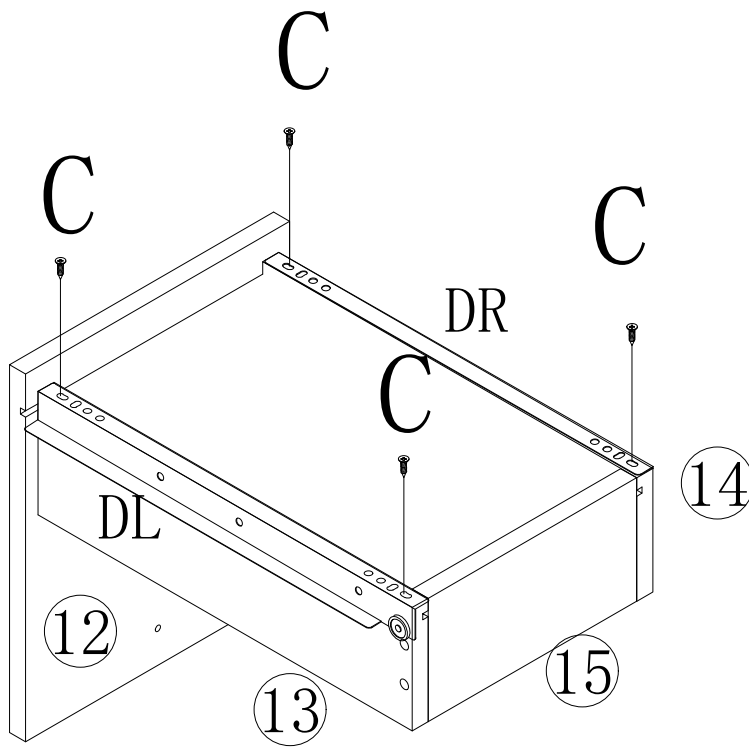

X2

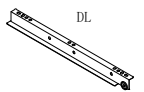
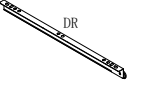
C		X8
DL		X2
DR		X2

Step 16

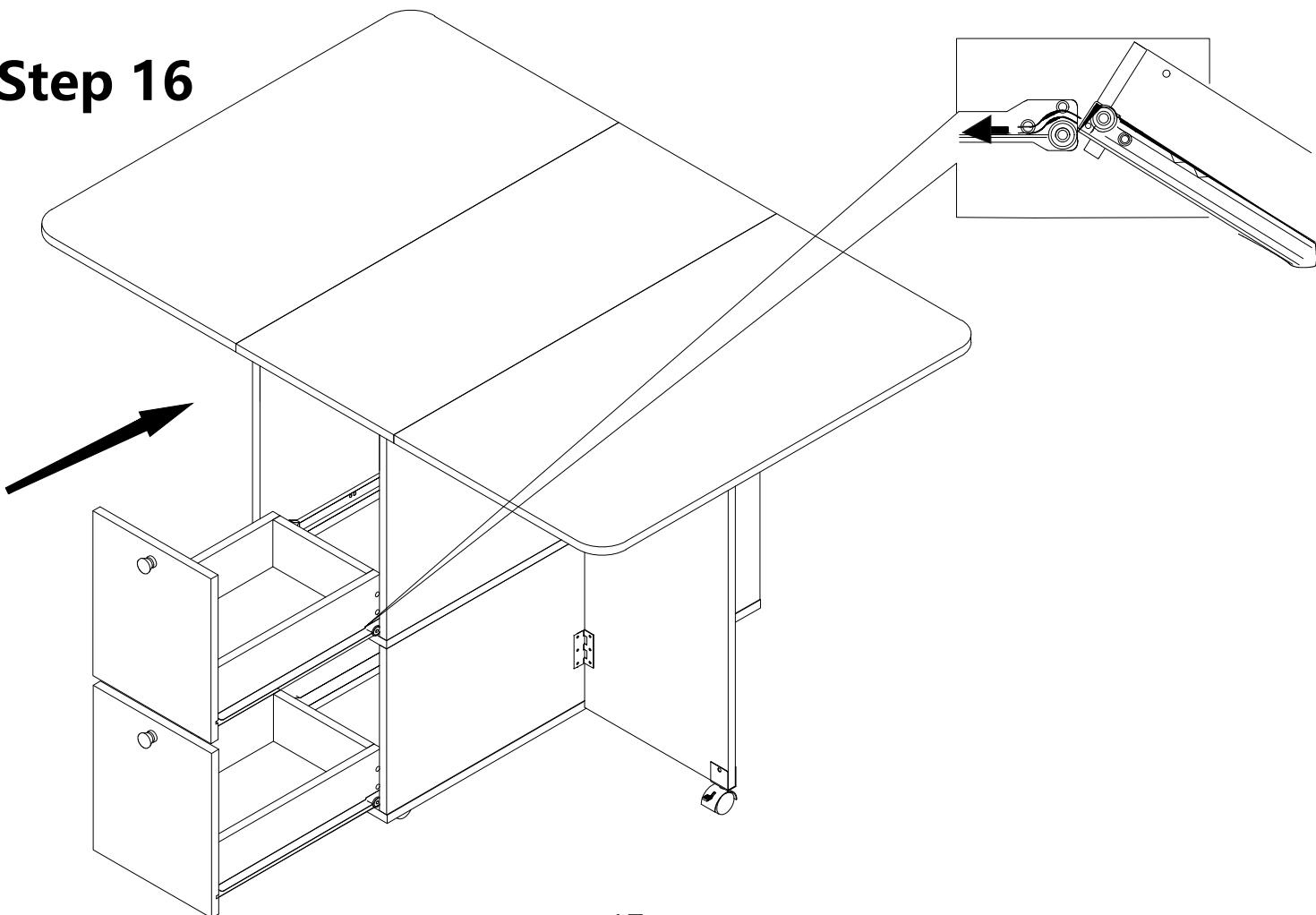

Step 17

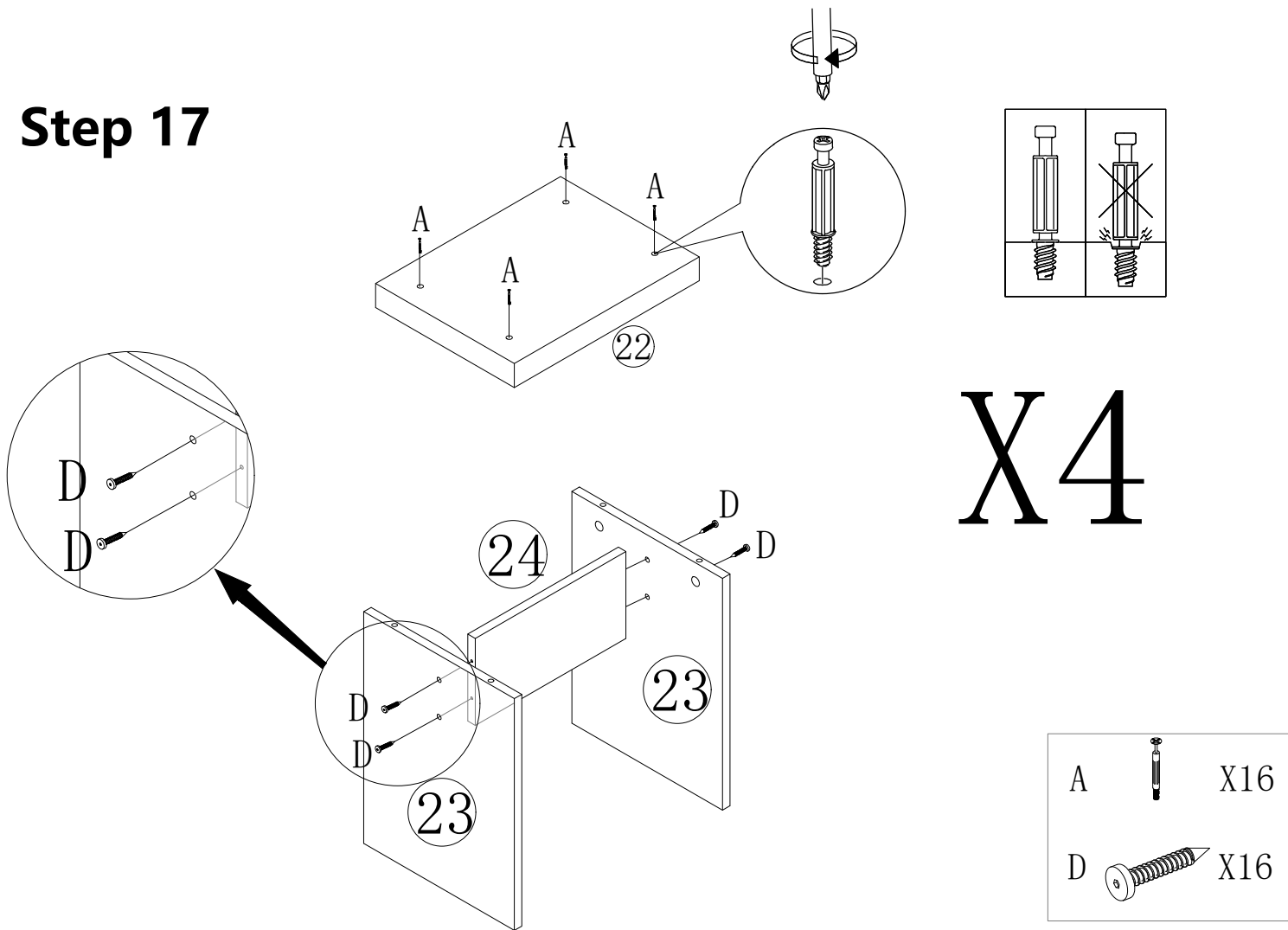

Step 18

