

Model: \_\_\_\_\_

Lot No: \_\_\_\_\_

Date of Purchase: \_\_\_\_\_

## FULL / QUEEN HEADBOARD

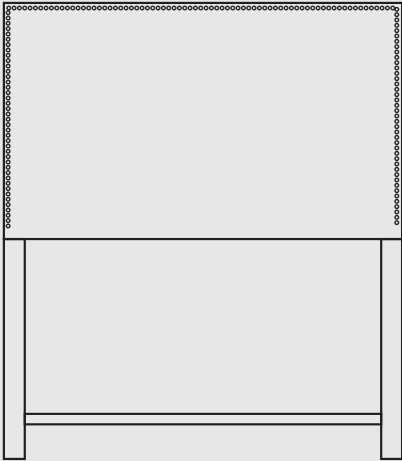

### ADULT ASSEMBLY REQUIRED

If you are missing any parts or have any questions regarding assembly, do not return this item to the retailer's store. Please call our toll-free customer service number and have this assembly manual open to the parts list ready to provide the model name, and part name or number.

Customer Service



### PARTS AND HARDWARE

Avoid using sharp objects such as a knife to cut open packing as you may accidentally damage the upholstery.



A. 1-3/4" Bolt  
20x

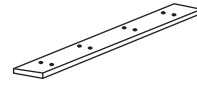

B. Connector  
2x

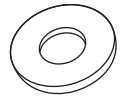

C. Shim  
24x



D. Spring  
24x



E. Wrench  
1x

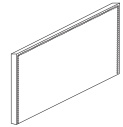

F. Headboard  
1x

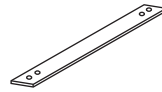

G. Foot Connector  
1x



H. 1" Bolt  
4x

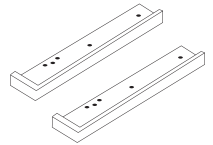

I. Foot  
2x

**WARNING:** This product may contain small components, please ensure they are kept away from small children.

### ASSEMBLY INSTRUCTIONS

1

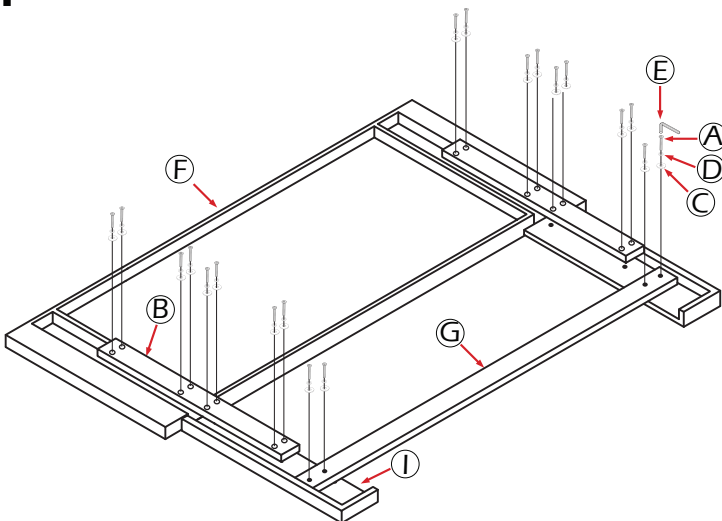

2

