

ASSEMBLY INSTRUCTIONS

Queen Size Bed Frame with Rattan Headboard

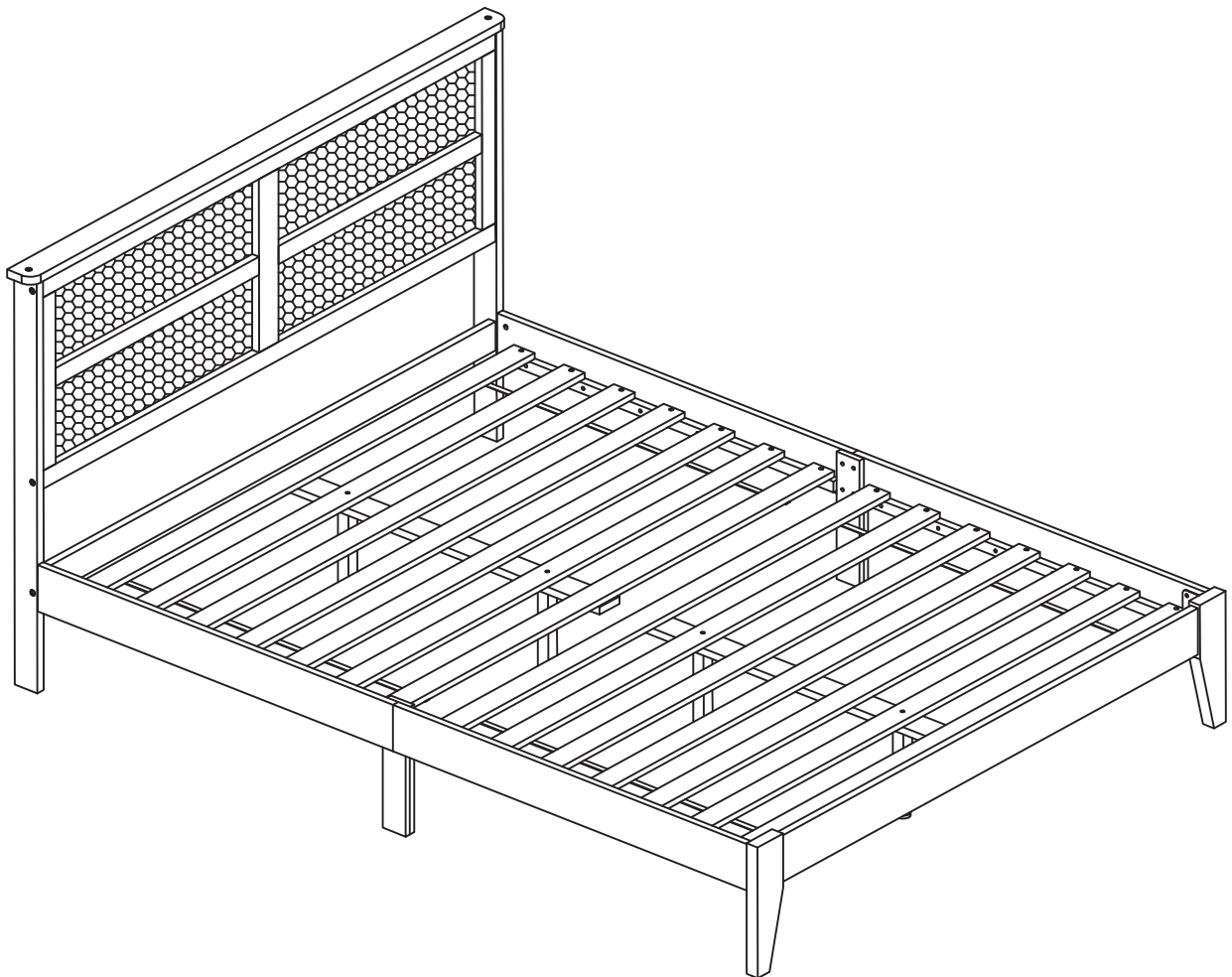





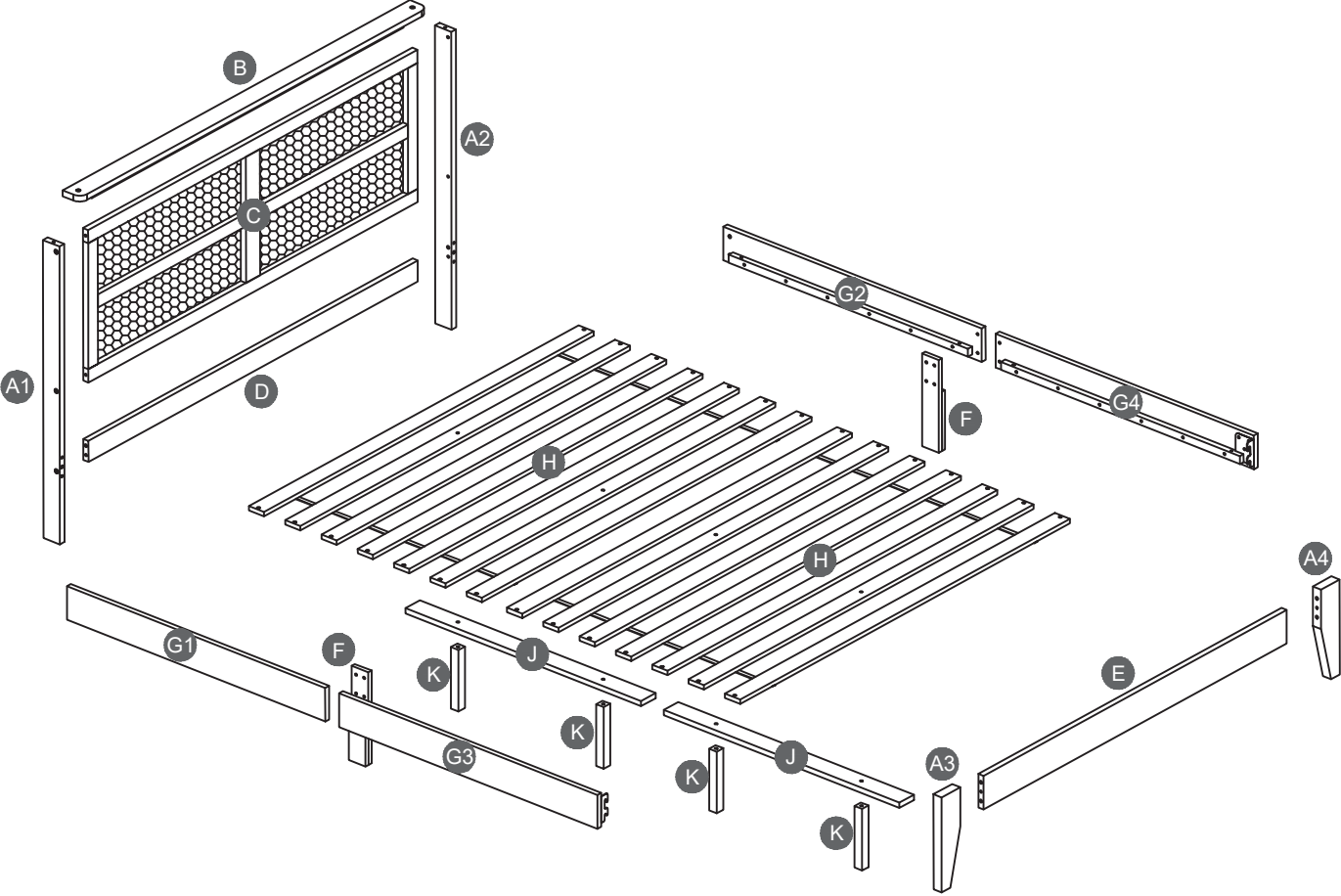







504LQQBD0910-NL



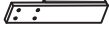

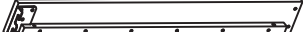
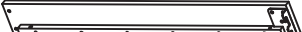

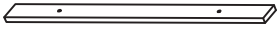
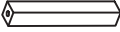



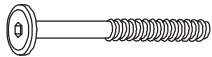

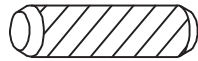
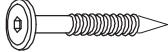
Detail View

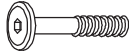

Part List

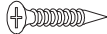
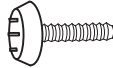
A1  Leg (Headboard Left) - 1pc	A2  Leg (Headboard Right) - 1pc	A3  Leg (Footboard Left) - 1pc
A4  Leg (Footboard Right) - 1pc	B  Top Panel (Headboard) - 1pc	C  Middle Panel (Headboard) - 1pc
D  Bottom Panel (Headboard) - 1pc	E  Panel (Footboard) - 1pc	F  Side Rail Support (Left & Right) - 2pcs
G1  Side Rail Left (Headboard) - 1pc	G2  Side Rail Right (Headboard) - 1pc	G3  Side Rail Left (Footboard) - 1pc
G4  Side Rail Right (Footboard) - 1pc	H  Bed Slats - 2Sets	J  Center Rail - 2pcs
K  Support Leg - 4pcs		

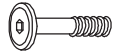
Hardware List

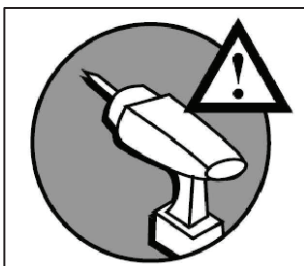
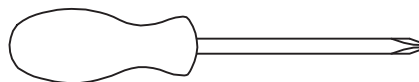

1  M6 x 60mm JCBC (12cs)	2  M6 x 15mm Barrel Nut (10pcs)	3  M10 x 30mm Wood Dowel (8pcs)
4  M6 x 40mm JCBC-W (2pcs)	5  M4 x 32mm CSK Screw (3pcs)	6  M6 Half Moon Nut (2pcs)
7  Flat Washer (2pcs)	8  Split Lock Washer (2pcs)	9  M6 x 25mm JCBC (8pcs)
10  M6 x 30mm JCBC-W (8pcs)	11  M4 x 25mm CSK Screw (20pcs)	12  Adjustable Screw (4pcs)
13  Flat Washer (8pcs)	14  M6 x 110mm JCBC (4pcs)	15  M8 x 20mm JCBB (4pcs)
16  M4 Allen Key (1pc)	17  M5 Allen Key (1pc)	

ASSEMBLY TOOLS REQUIRED (NOT INCLUDED)



PLEASE BE CAREFUL DO NOT DAMAGE THE HOLE POSITION WHEN YOU USE POWER TOOLS !

STEP 1:

1		2		3	
6PCS		6PCS		2PCS	

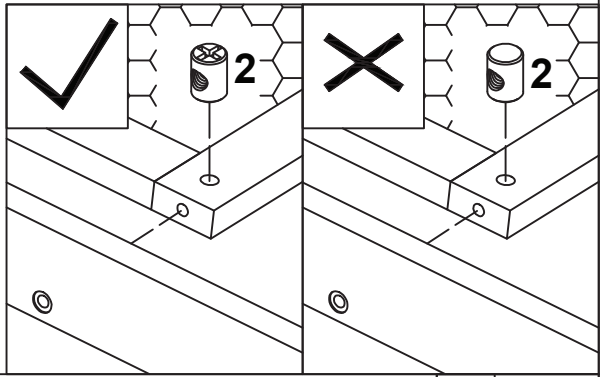
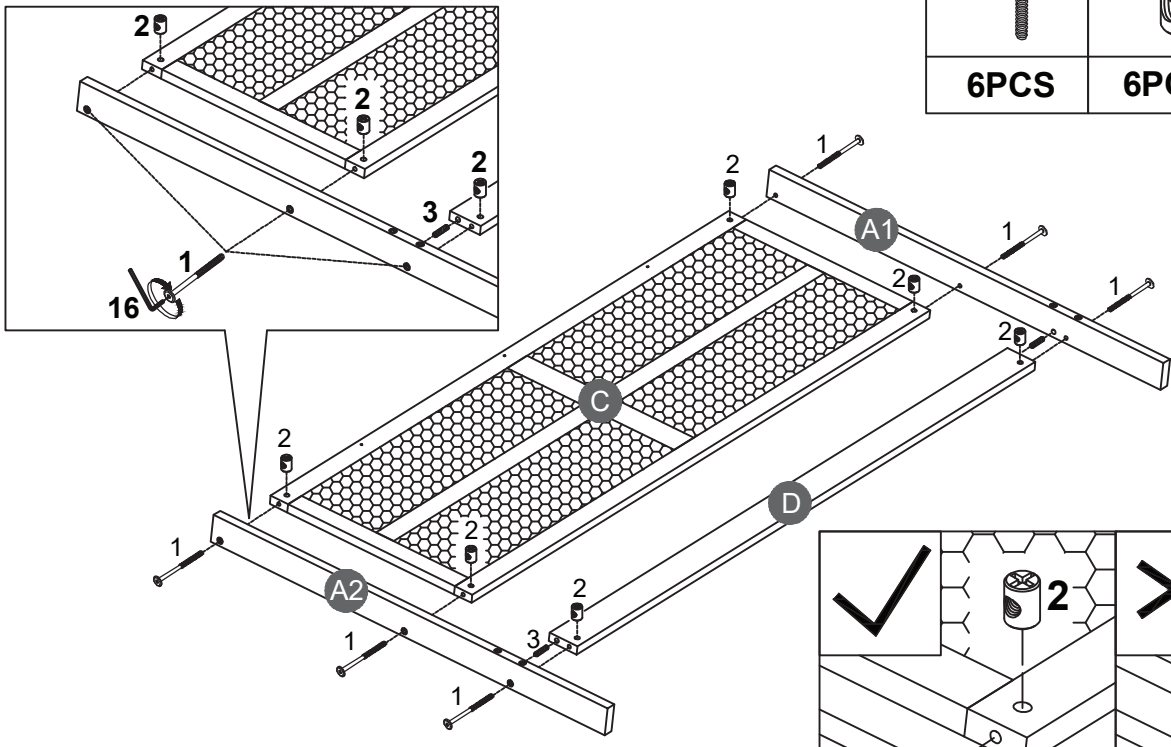

Note: Part 2 will face up with the "x" mark on it, otherwise it cannot be tightened

STEP 2:

4	
2PCS	

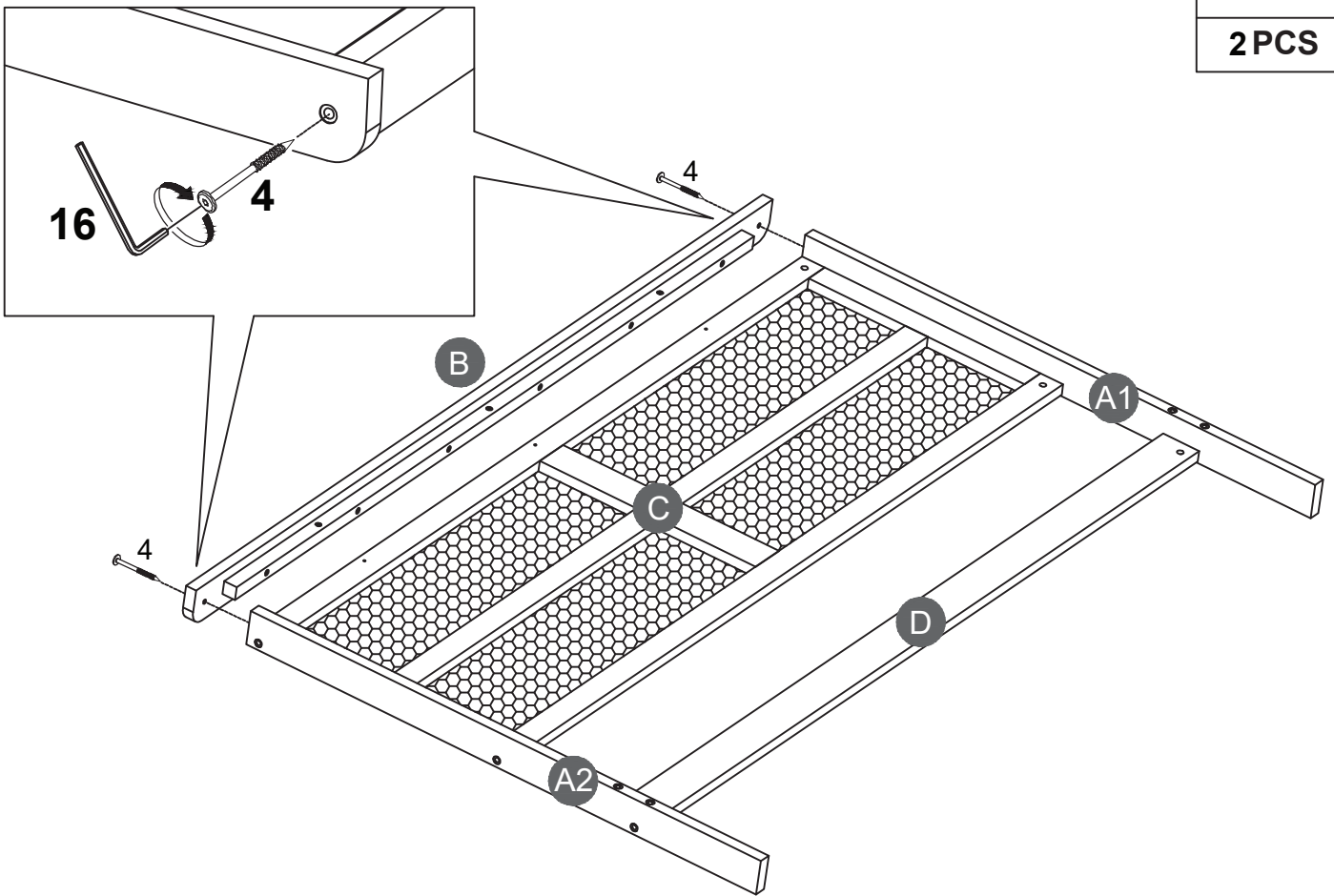

STEP 3:

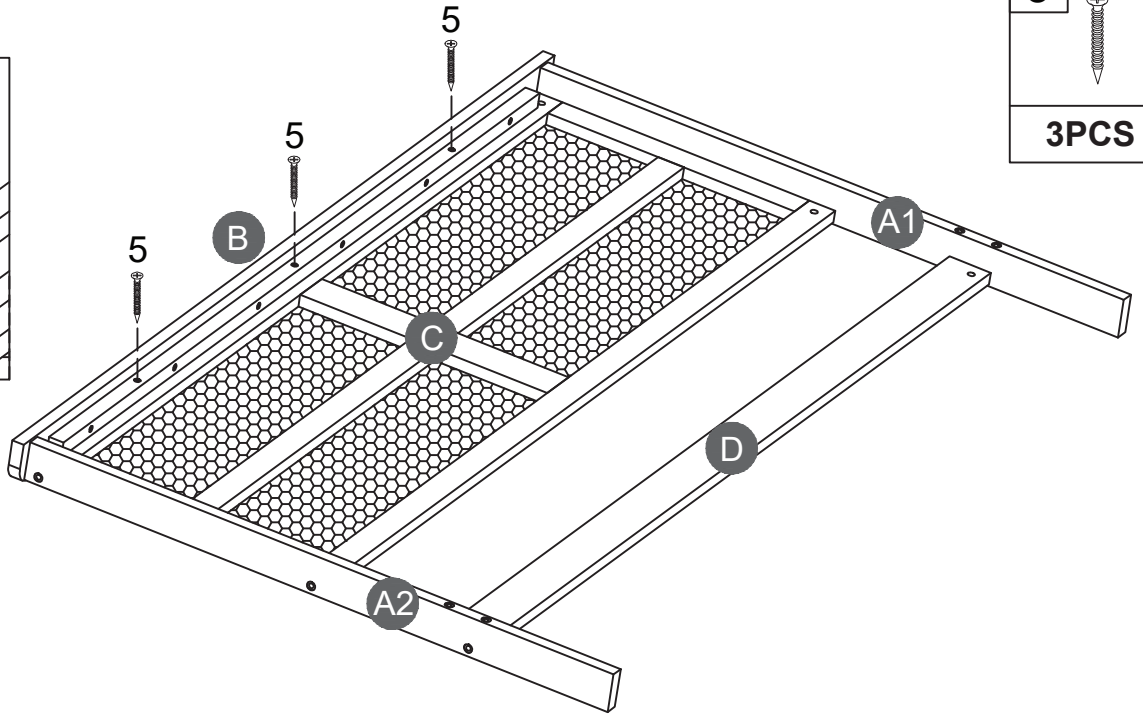
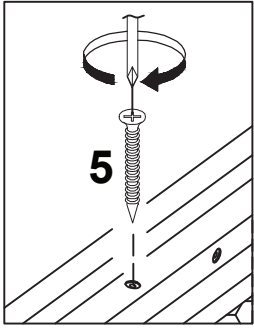

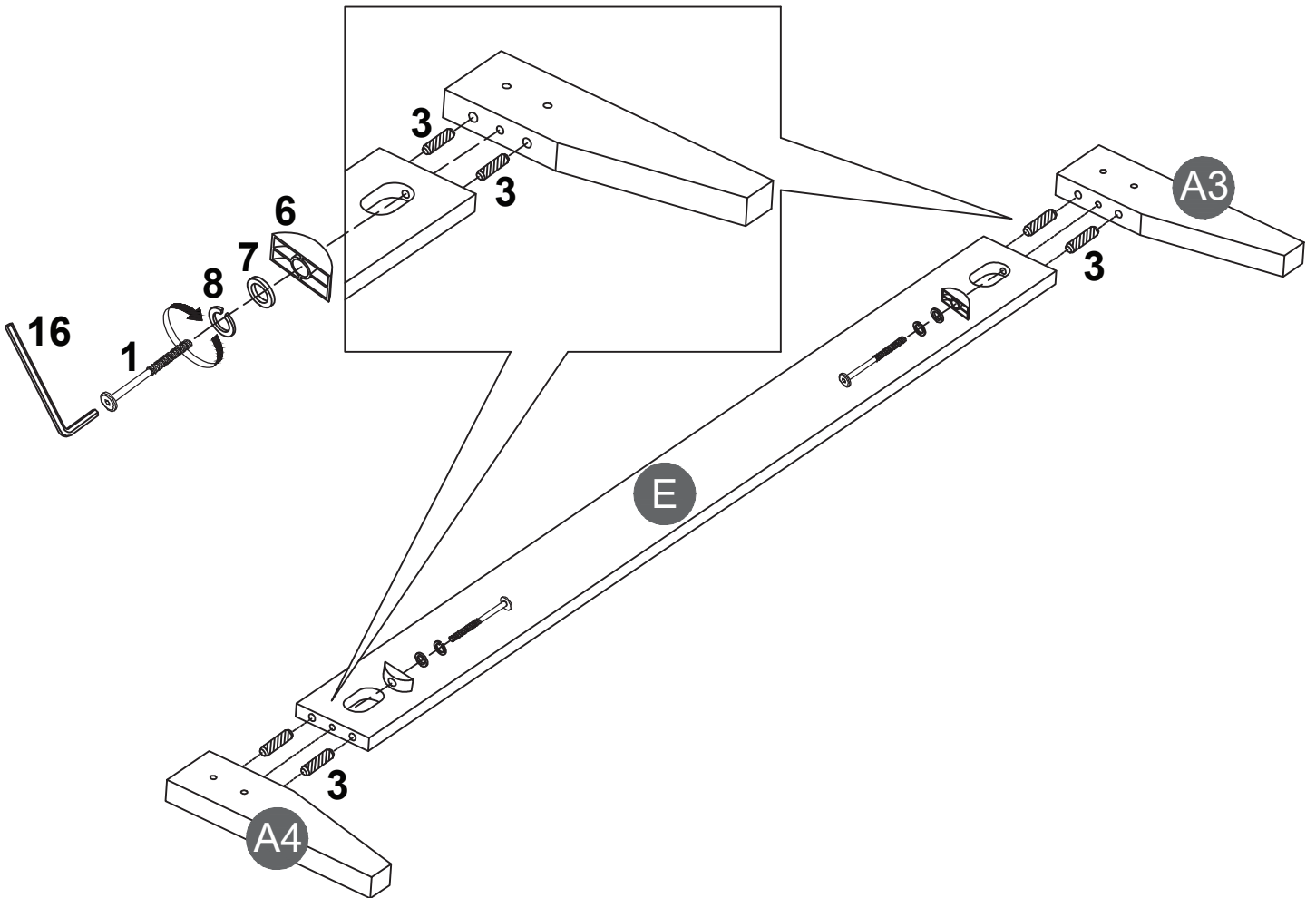

STEP 4:

1		3		6		7		8	
	2PCS		4PCS		2PCS		2PCS		2PCS





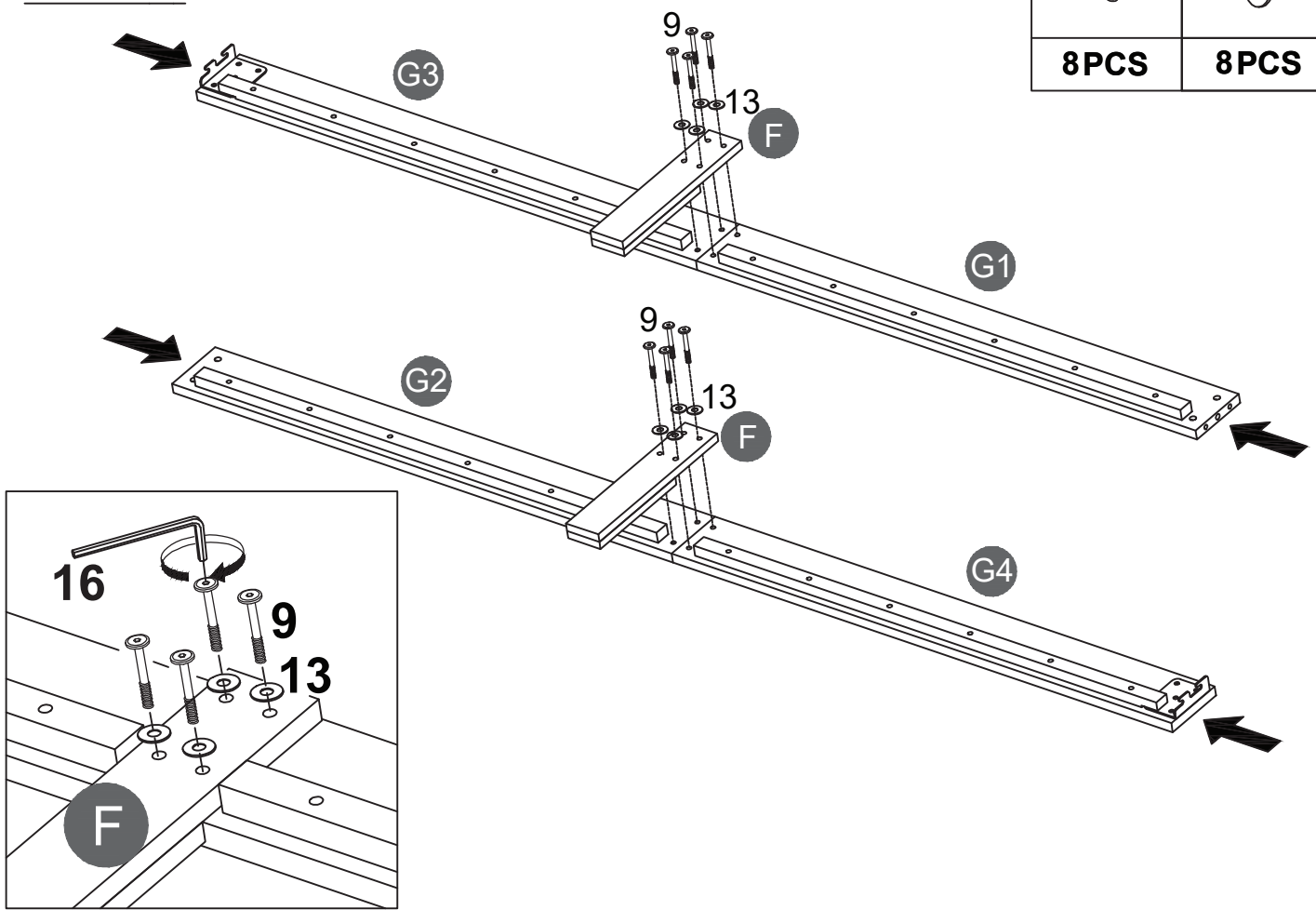

STEP 5:

9		13	
8PCS		8PCS	



STEP 6:



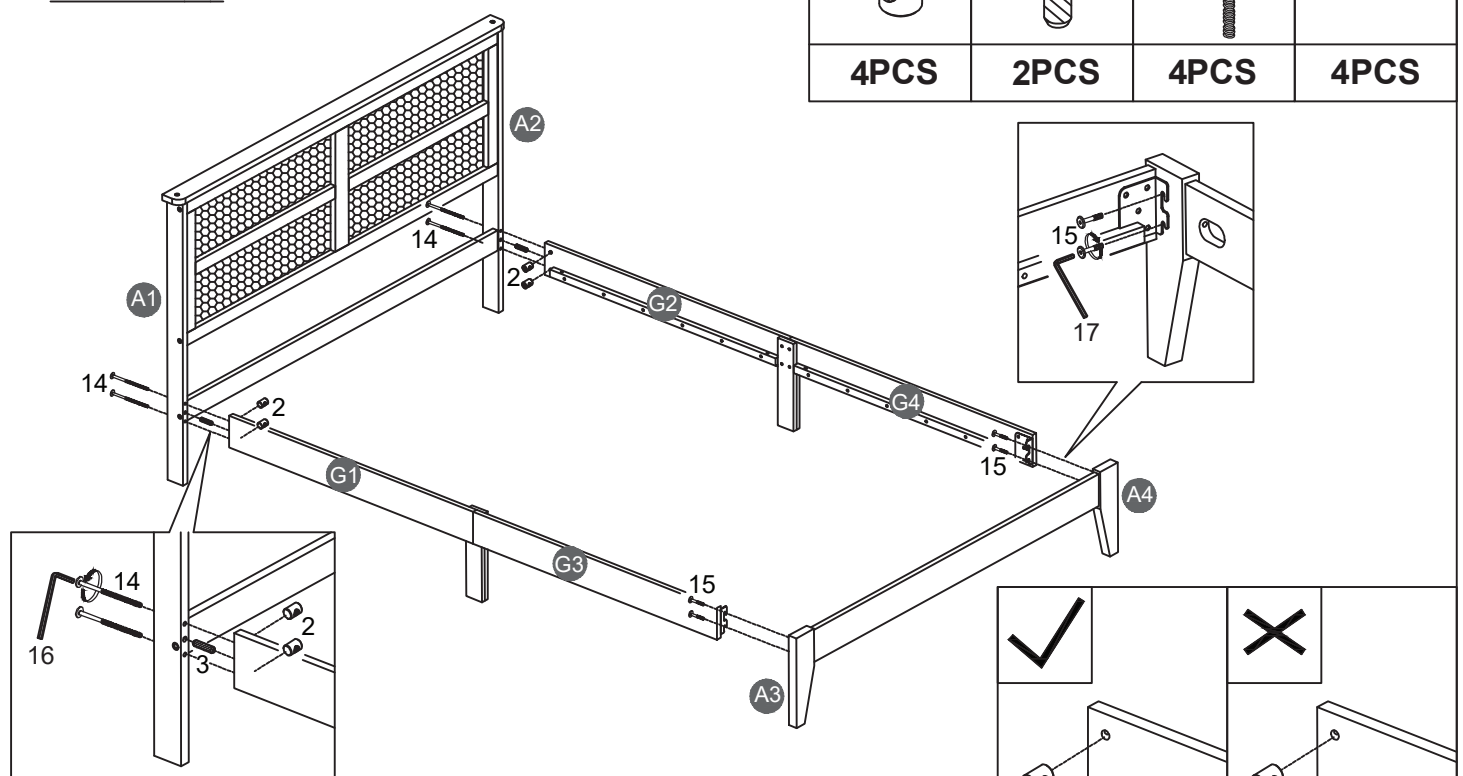

2		3		14		15	
4PCS		2PCS		4PCS		4PCS	

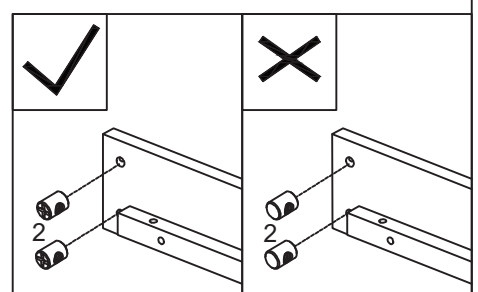

Note: Part 2 will face up with the "x" mark on it, otherwise it cannot be tightened



STEP 7:

1		10		11		12	
4PCS		8PCS		20PCS		4PCS	

