



| ▲ AVERTISSEMENT  | ▲ WARNING   |  |
|--|---|---|
| <p><b>Des enfants sont morts à cause du renversement de meubles. Pour réduire le risque de renversement des meubles:</b></p> <ul style="list-style-type: none"> <li>• Installez TOUJOURS le dispositif anti- basculement fourni.</li> <li>• NE JAMAIS placer un téléviseur sur ce produit.</li> <li>• NE JAMAIS laisser un enfant se tenir debout sur les tiroirs, les portes ou les tablettes, y grimper ou s'y suspendre.</li> <li>• N'ouvrez JAMAIS ouvrir plus d'un tiroir à la fois.</li> <li>• Mettre les objets les plus lourds dans les tiroirs du bas.</li> </ul> | <p><b>Children have died from furniture tipover. To reduce the risk of furniture tipover:</b></p> <ul style="list-style-type: none"> <li>• ALWAYS install anti-tip device provided.</li> <li>• NEVER put a TV on this product.</li> <li>• NEVER allow children to stand, climb, or hang on any drawers, doors or shelves.</li> <li>• NEVER open more than one drawer at a time.</li> <li>• Place heaviest items in the lowest drawers.</li> </ul> |  |
| <p><i>Cette étiquette est permanent<br/>Ne pas la retirer !</i></p>  | <p><i>This is a permanent label.<br/>Do not remove !</i></p>  |   |



(A)

x1 Chest  
x1 Commode  
x1 Cómoda

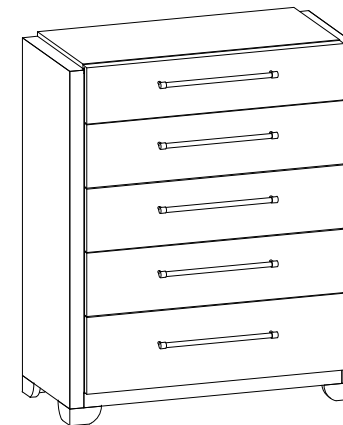
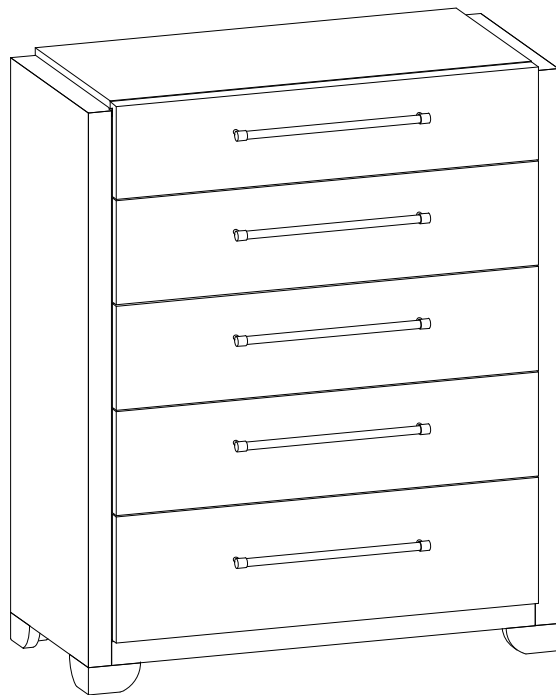
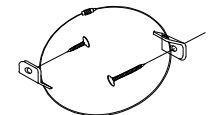

(B)

x1 Anti-tipping Restraint \*  
x1 Systeme antibasculement  
x1 Control para evitar vulcos

\* Replaceable Part

| ▲ AVERTISSEMENT  | ▲ WARNING  |   |
|--|--|---|
| <p><b>Des enfants sont morts à cause du renversement de meubles. Pour réduire le risque de renversement des meubles:</b></p> <ul style="list-style-type: none"> <li>• Installez TOUJOURS le dispositif anti- basculement fourni.</li> <li>• NE JAMAIS placer un téléviseur sur ce produit.</li> <li>• NE JAMAIS laisser un enfant se tenir debout sur les tiroirs, les portes ou les tablettes, y grimper ou s'y suspendre.</li> <li>• N'ouvrez JAMAIS ouvrir plus d'un tiroir à la fois.</li> <li>• Mettre les objets les plus lourds dans les tiroirs du bas.</li> </ul> <p><i>Cette étiquette est permanent<br/>Ne pas la retirer !</i></p> | <p><b>Children have died from furniture tipover. To reduce the risk of furniture tipover:</b></p> <ul style="list-style-type: none"> <li>• ALWAYS install anti-tip device provided.</li> <li>• NEVER put a TV on this product.</li> <li>• NEVER allow children to stand, climb, or hang on any drawers, doors or shelves.</li> <li>• NEVER open more than one drawer at a time.</li> <li>• Place heaviest items in the lowest drawers.</li> </ul> <p><i>This is a permanent label.<br/>Do not remove !</i></p> |  |

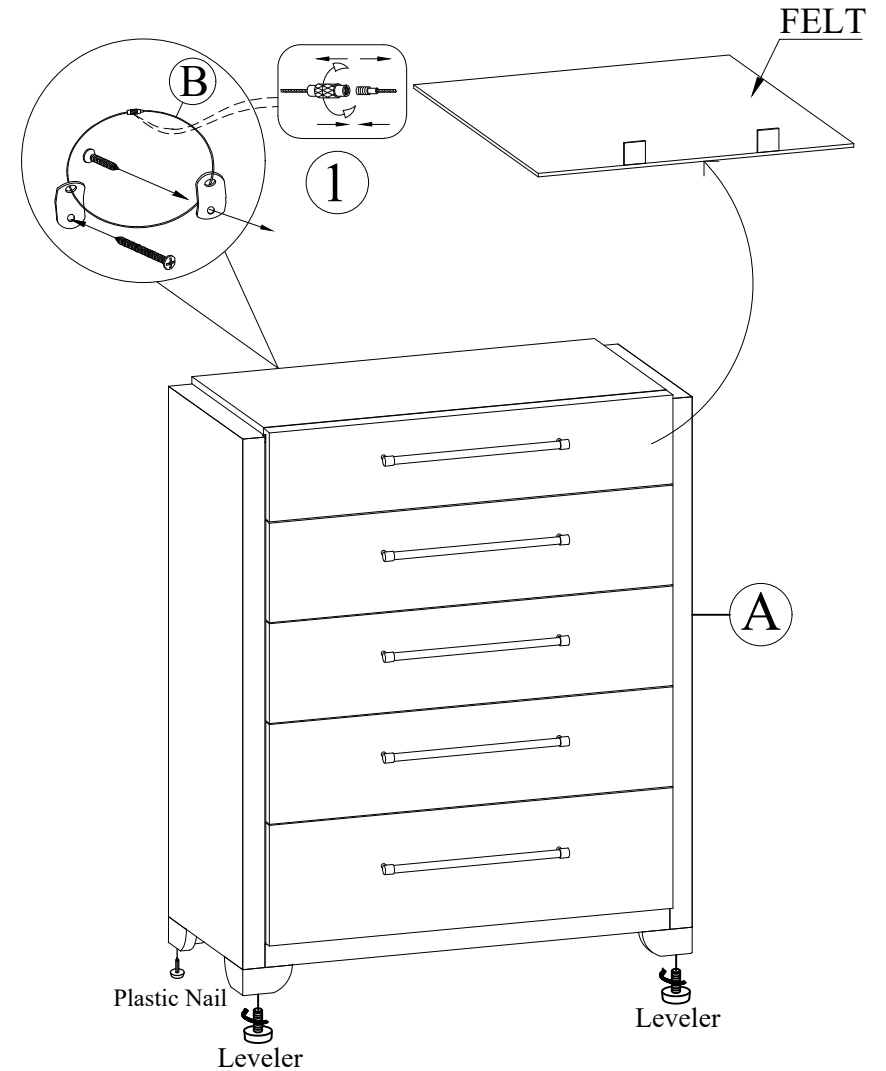
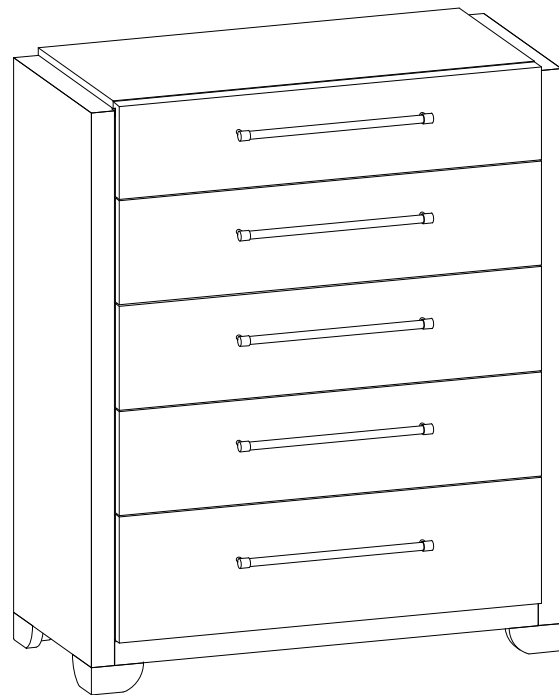

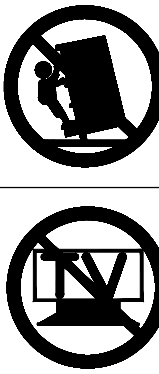
| ▲ AVERTISSEMENT  | ▲ WARNING  |   |
|--|--|---|
| <p><b>Des enfants sont morts à cause du renversement de meubles. Pour réduire le risque de renversement des meubles:</b></p> <ul style="list-style-type: none"> <li>• Installez TOUJOURS le dispositif anti- basculement fourni.</li> <li>• NE JAMAIS placer un téléviseur sur ce produit.</li> <li>• NE JAMAIS laisser un enfant se tenir debout sur les tiroirs, les portes ou les tablettes, y grimper ou s'y suspendre.</li> <li>• N'ouvrez JAMAIS ouvrir plus d'un tiroir à la fois.</li> <li>• Mettre les objets les plus lourds dans les tiroirs du bas.</li> </ul> <p><i>Cette étiquette est permanent<br/>Ne pas la retirer !</i></p> | <p><b>Children have died from furniture tipover. To reduce the risk of furniture tipover:</b></p> <ul style="list-style-type: none"> <li>• ALWAYS install anti-tip device provided.</li> <li>• NEVER put a TV on this product.</li> <li>• NEVER allow children to stand, climb, or hang on any drawers, doors or shelves.</li> <li>• NEVER open more than one drawer at a time.</li> <li>• Place heaviest items in the lowest drawers.</li> </ul> <p><i>This is a permanent label.<br/>Do not remove !</i></p> |  |

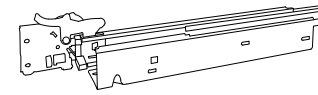
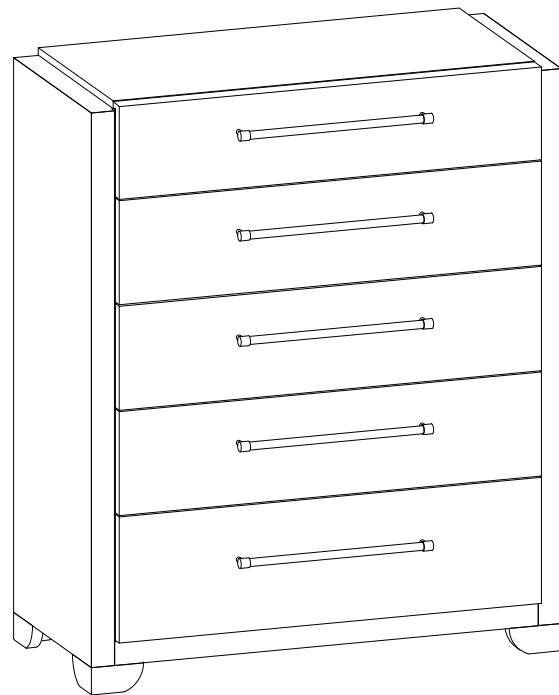

x5 RP402100-GLIDE \*  
Undermount Soft Close  
Fermeture douce sous-montée  
Cierre suave con montaje inferior

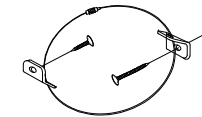

x1 RC-ANTI-TIP-M \*  
Anti-tipping Restraint \*  
Système antibasculement  
Control para evitar vulcos



x5 RCP402-LHANDLE \*  
Long Handle With Screw  
Poignée Longue Avec Vis  
Manija Larga Con Tornillo

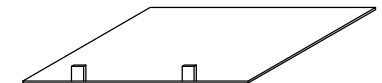

x1 RP402124-FELT \*  
Removable Felt \*  
Feltre  
Fieltro



x2 RC-LEVE-White \*  
White Leveler \*  
Patin réglable  
Nivelador



x2 RC-WH-NAIL \*  
White Plastic Nail \*  
Clou en plastique  
Clavo de plástico

\* Replaceable Part