

Big and Tall Office Chair Installation Manual

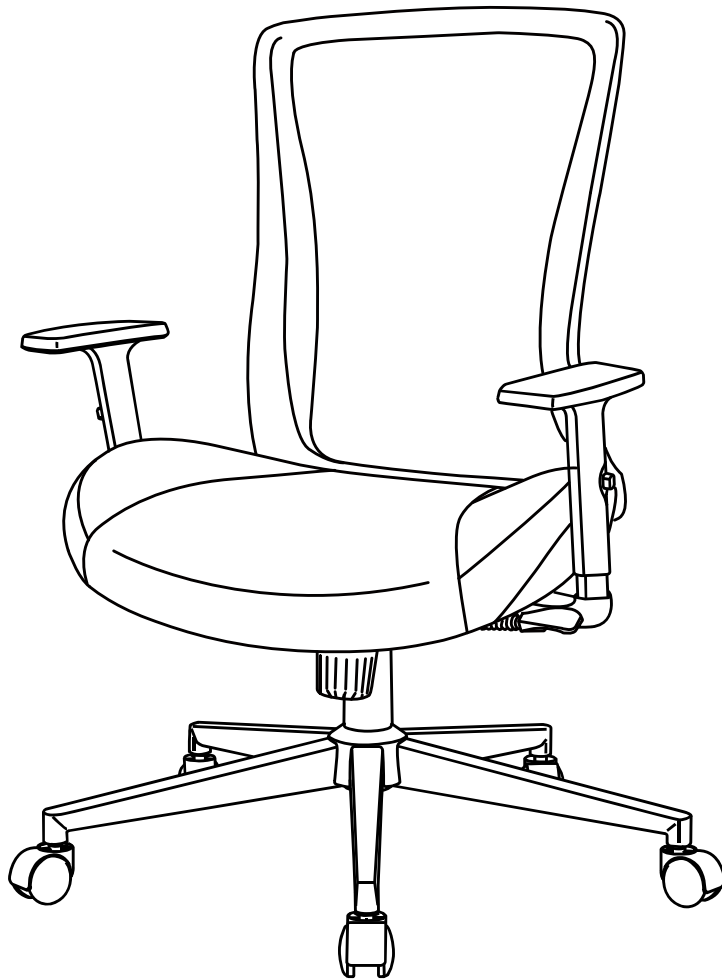

Instruction Manual

Contents

Make sure that the package contains the following parts:

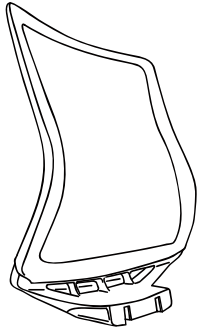

① Back Cushion(1)

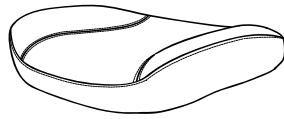

② Seat Cushion(1)

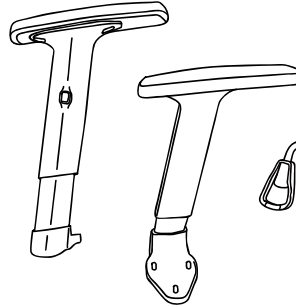

③ Arms(2)

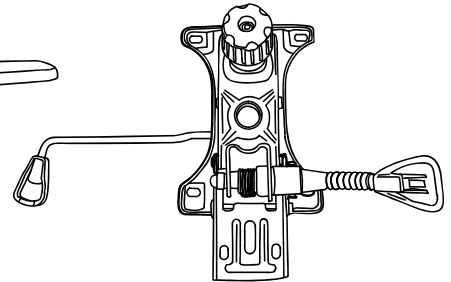

④ Seat Plate(1)



⑤ Gas Lift(1)

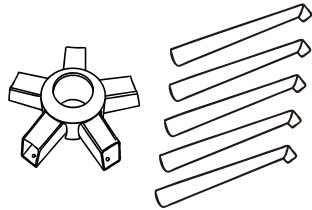

⑥ Star Base(1)

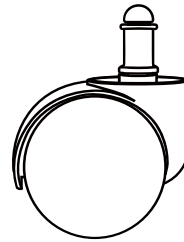

⑦ Casters(5)

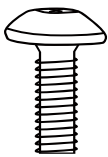

Bolts M6*14mm(5)

(A)

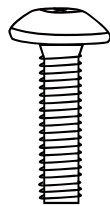

Bolts M6*25mm(2)

(B)

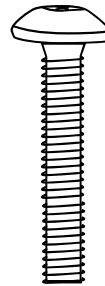

Base Bolts M6*35mm(8)

(C)

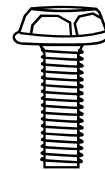

Bolts 5/16" *7/8"(3)

(D)

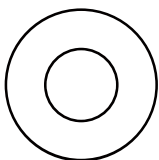

Washers M8*18mm(7)

(E)

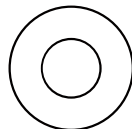

Washers M6*15mm(6)

(F)

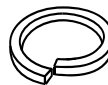

Split Washers M8(9)

(G)

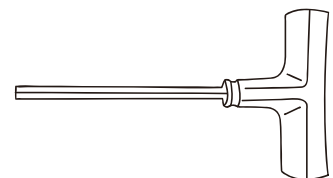

Wrench(1)

(H)

Attention

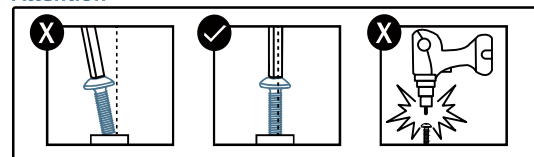

Step 1: Attach The Bottom

1. Turn the star base upside down, insert the detachable feet in turn to the star base, secure the feet with five (A) bolts with the wrench (H).
2. Press the casters into the holes at the end of each base leg.
3. Insert the gas lift into the center hole of the star base.

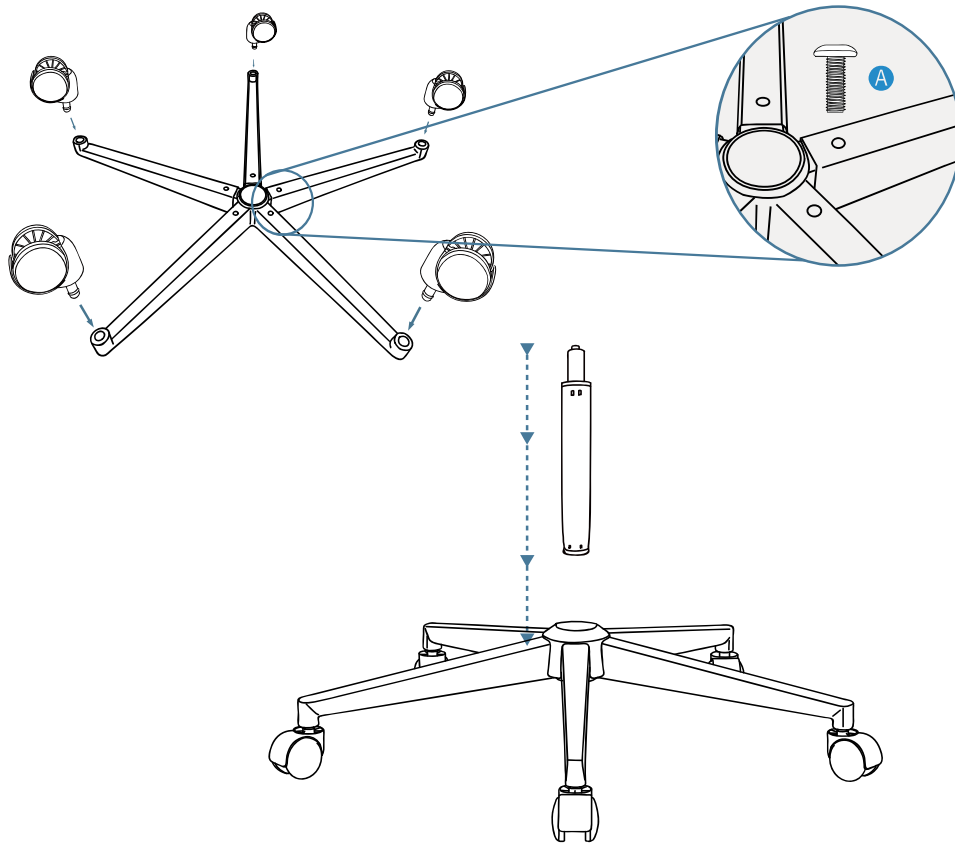

Step 2: Attach the Armrests, Back Cushion & Seat Plate

1. Fix the Arms^③ on the Seat Cushion^② with Six Bolts(C) Six Split Washers(G) and Six Washers (F).

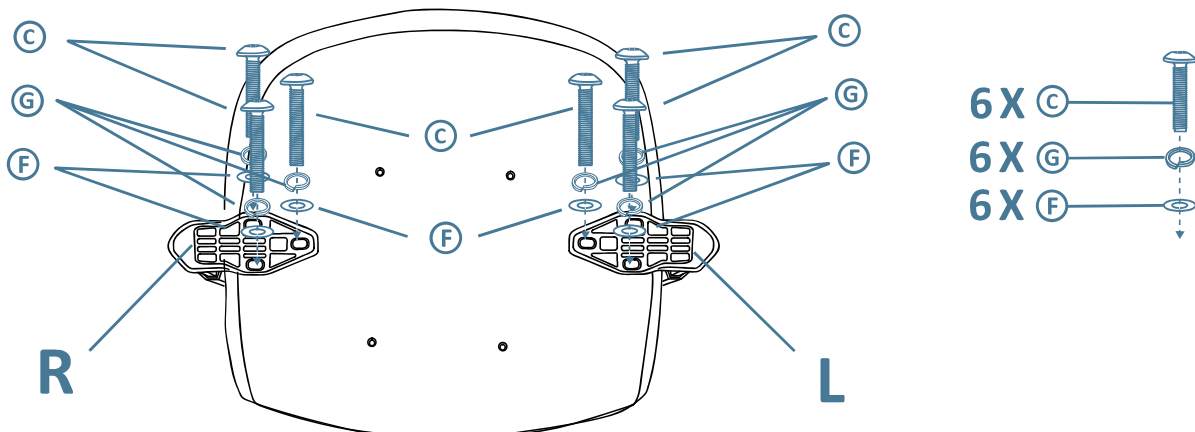

2. Attach the Seat Plate④ to the seat using Two Bolts(C), Two Bolts(B) and Four Washers(E).

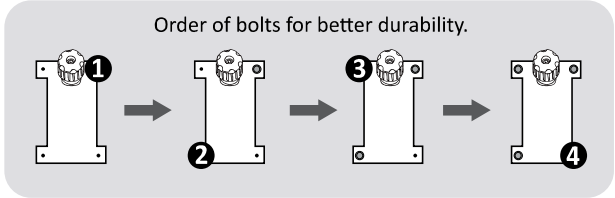
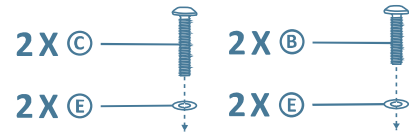
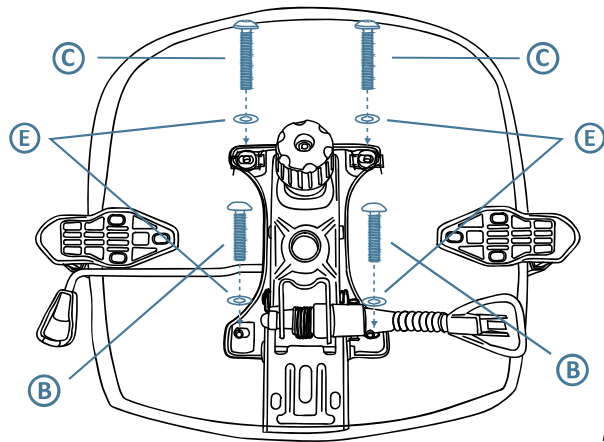

Note: Being careful not to miss thread the bolts or damaged the seat.

3. Attach the Back Cushion① to the seat using Three Bolts(D), Three Split Washers(G) and Three Washers(E).

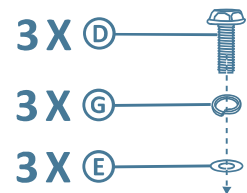
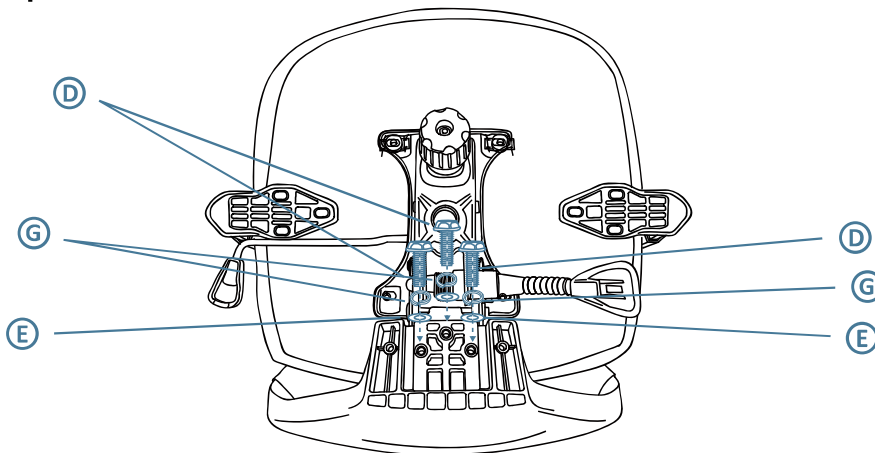

Step 3: Push the Seat Cushion Down onto the Lift

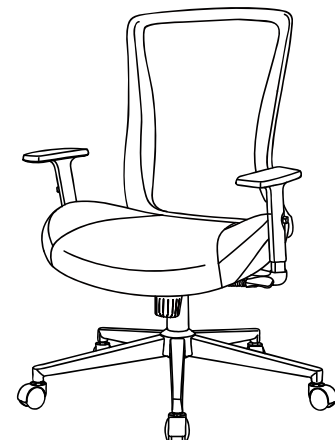
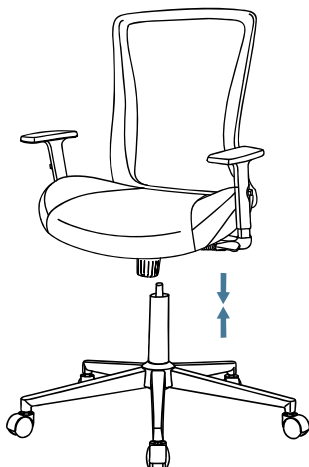

Make sure all bolts and screws are fully tightened before using chair.

Instruction Manual

1. Seat Height Adjustable

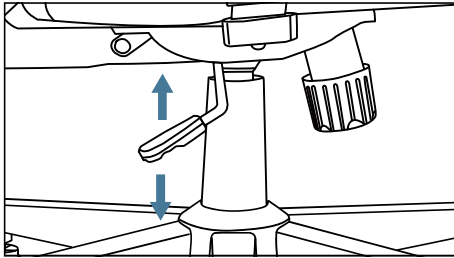

To raise:

While taking your weight off chair, lift lever up.



To lower:

While seated, lift lever up.

2. Rocking Pressure Adjustor

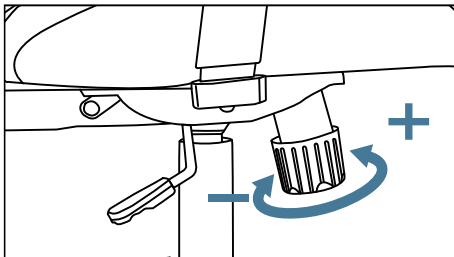

To increase tension:

Turn the tilt knob counter-clockwise.



To decrease tension:

Turn the tilt knob clock wise.

3. Rocking Function

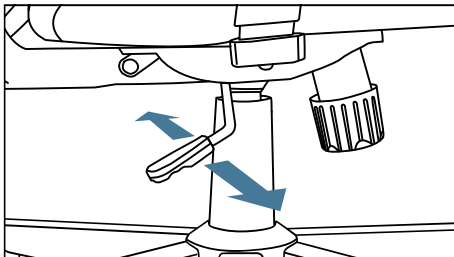

To let your chair rocking, pull the lever out.

4. Lock Function

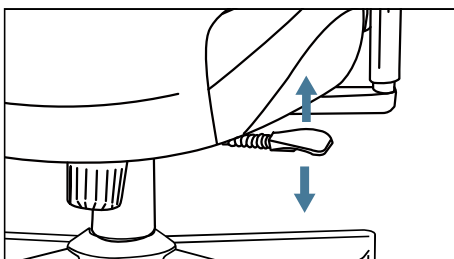

To lock the back to different angles, pull the lever down.

5. Adjustable Armrests

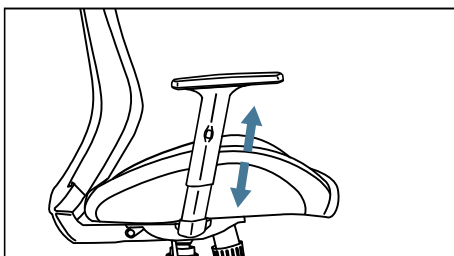

Gently press the button on the armrest, the armrest can be adjusted up and down.