

Installation Instructions



Chandelier Installation and Safety Standards

The installation of a chandelier is a crucial step in ensuring its safety. Chandelier safety standards dictate the process of installation, including the tools and equipment that can be used, the methods of securing the chandelier, and the location of the chandelier.

Securing the chandelier is a crucial step in the installation process. Chandelier safety standards dictate that the chandelier must be securely attached to a suitable support, such as a ceiling joist, to prevent it from falling. This includes ensuring that the support is strong enough to bear the weight of the chandelier, and that the chandelier is properly balanced to prevent it from tipping or swaying.

Furthermore, the chandelier must be secured using suitable hardware, such as screws or bolts, that are strong enough to bear its weight. The hardware must be properly installed and tightened to ensure that the chandelier is securely attached. Regular inspections of the hardware are also necessary to detect and repair any damage or wear promptly.

Package

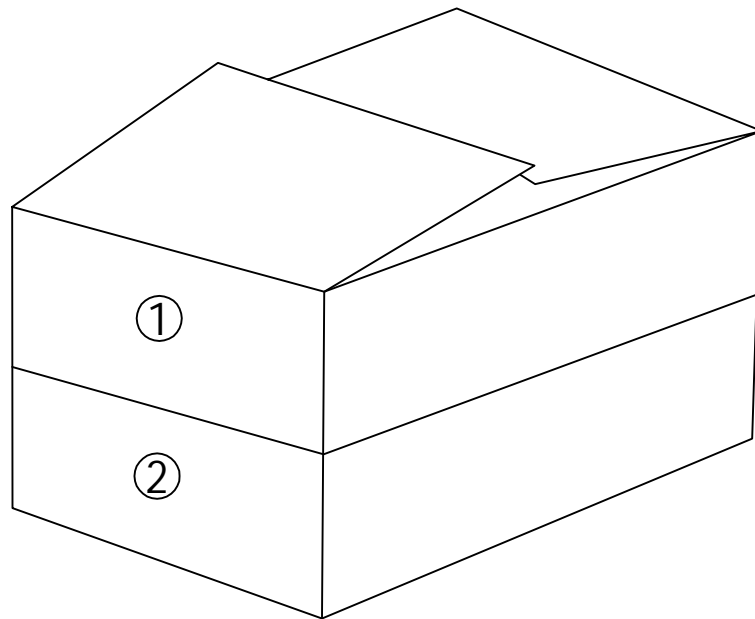

①

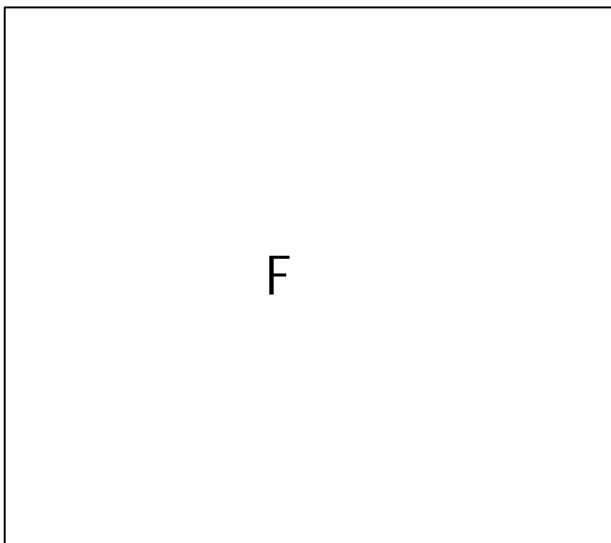

②

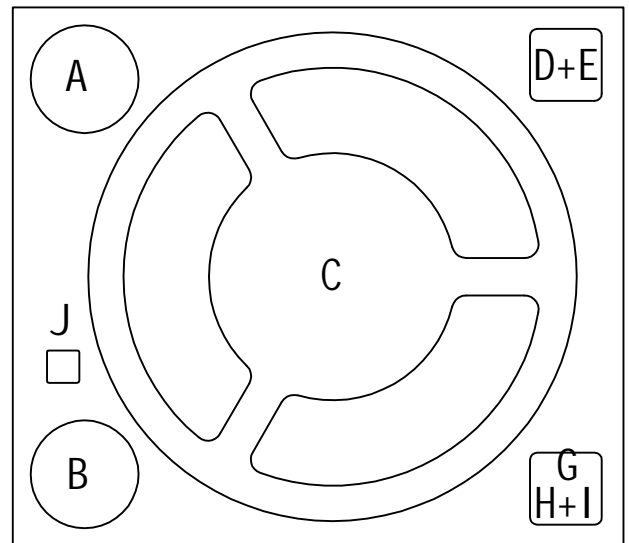

Internal packing list:

1. The first layer contains the lamp body
2. The second layer contain lamp body + crystal + lamp body accessories

Before assembly:

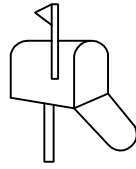

- ★ Please read all the instructions carefully
- ★ Keep the instruction manual for future reference.
- ★ Separate and inventory all parts and hardware
- ★ Read each step carefully and follow the correct installation sequence
- ★ To avoid losing any parts during assembly, we recommend not moving the lamp before completing the assembly. Always place the product on a flat, firm, and stable surface
- ★ Keep all small parts and packaging materials of this product away from babies and children, as they may cause serious injury

Accessory list

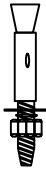

4pcs



2+2pcs



8pcs



A. Ceiling mount-1pc

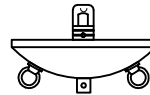

B. Main light base - 1pc

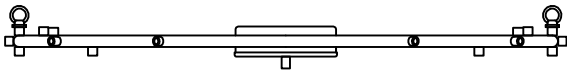

C. Main light body - 1pc

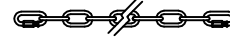

D. Hanging chain-1+1+1pcs

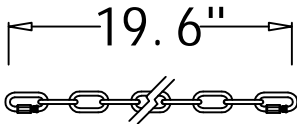

E. Hanging chain-3pcs

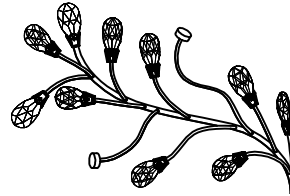

F. Main light body-21pcs

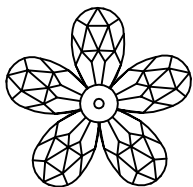

G. Crystal Flower-42+4pcs



H. Decorative pieces- 84+8 pieces



I. Bald nuts - 42+4pcs



J. Crystal Ball-1pc

① Fixture Assembly:

- (1). Locate the lamp body from the sorting list.
- (2). Connect the main lamp frame C to the main lamp frame B using the hanging chain E as shown.
- (3). Pass the power cord through the main lamp frame B and then through the hanging chain D.
- (4). Use the hanging chain D to connect the main lamp frame B to the ceiling clock A, and plug the power cord into the ceiling clock A.
- (5). Install the crystal ball J on the main lamp frame C.
- (6). Install the items H, G, and I in sequence on the main lamp frame F as shown.

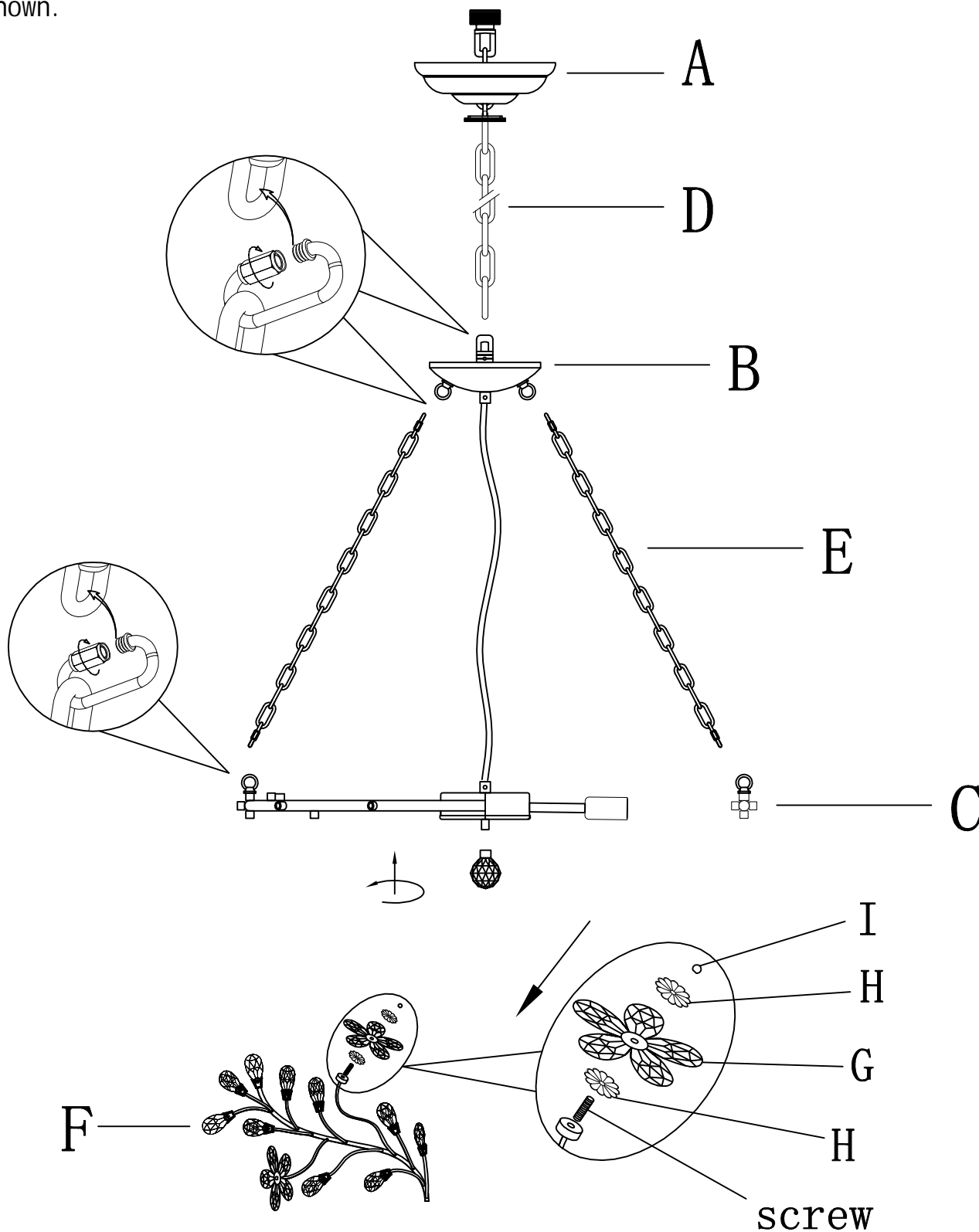

② Light Source and Lampshade Assembly:

- (1). Remove the mounting plate and connect it to the wall.
- (2). Connect the power cord to the main cable of the lamp body and secure the ceiling mount.
- (3). Screw six E12 bulbs into the lamp holder.
- (4). Install the assembled F main light bracket onto the C main light bracket and tighten with screws.
- (5). Installation is complete.



WARNING: E12 The light bulb,
MAX25W TYPE B BULB* 6PCS.

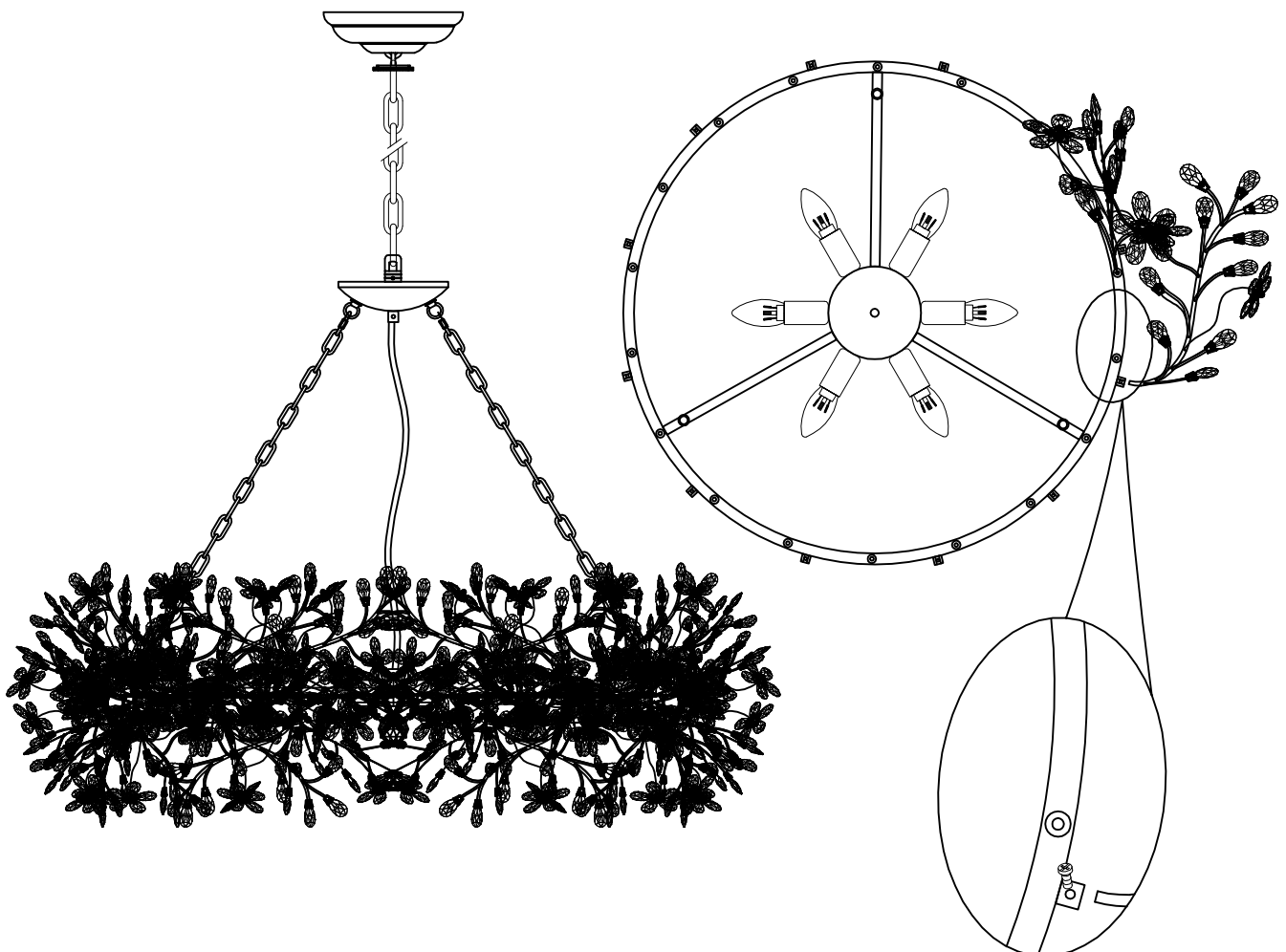
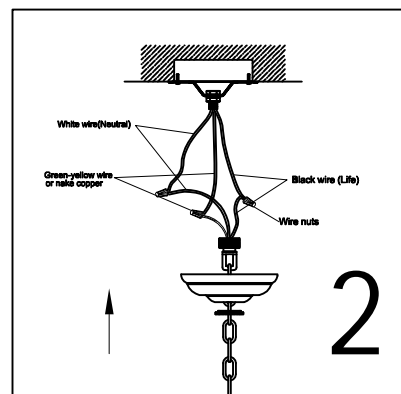
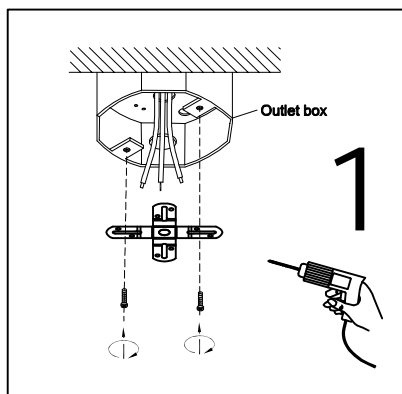

★ If your product has any issues upon receipt, please:

1. Provide your order number.

2. Attach a photo or video of the issue.

3. Contact us through the platform's customer service.