

Assembly Instructions

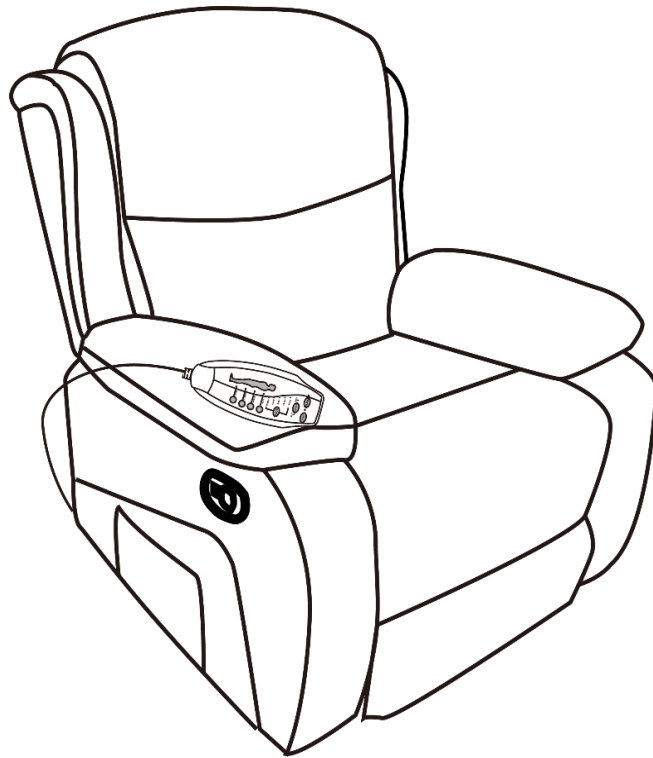

Caution : You must read this before you proceed

Massage Chair

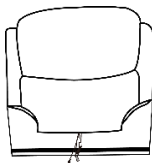
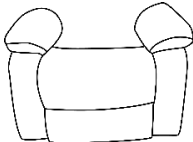

Parts List

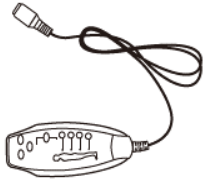
Label	Picture	Description	QTY
A		Chair Backrest	1
B		Chair Base with Footrest	1

C		Massage Remote	1
D		Plug	1

Assembly Preparation

Before Beginning Assembly:

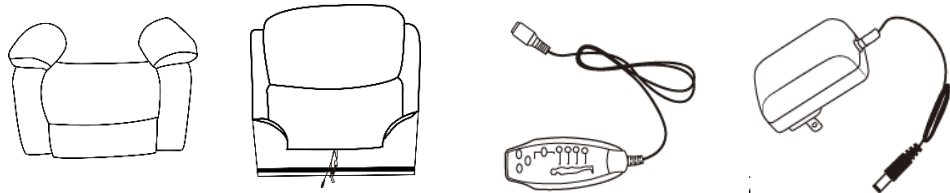

- Read instructions, cover to cover-



- Have 2 adults on hand for assembly-



- Do not assemble on flooring or carpet-



- Assemble on a clean non-marring surface (packing foam)-



- Save all packaging until finished-

Assembly Steps

Parts Introduction

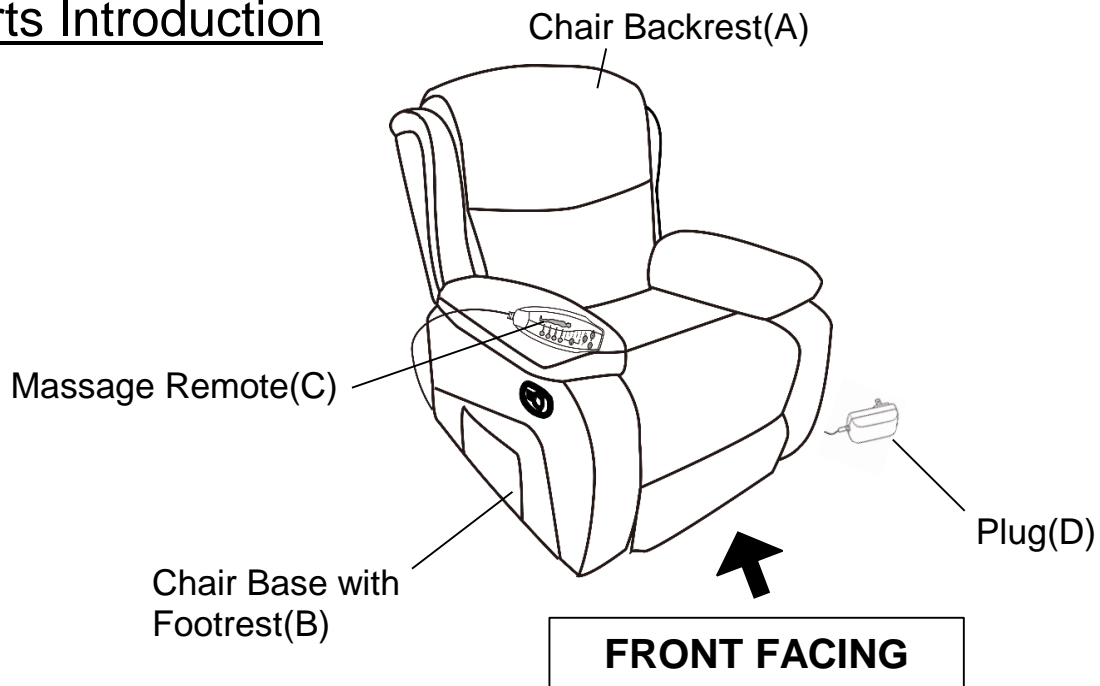

This Massage Chair has multiple parts and may require up to 30 minutes to assemble. To give you an overview of the Massage Chair parts, the above picture is to help you put the various parts into perspective. Please read through the instructions below to familiarise yourself with the parts and steps before assembly.

Step 1

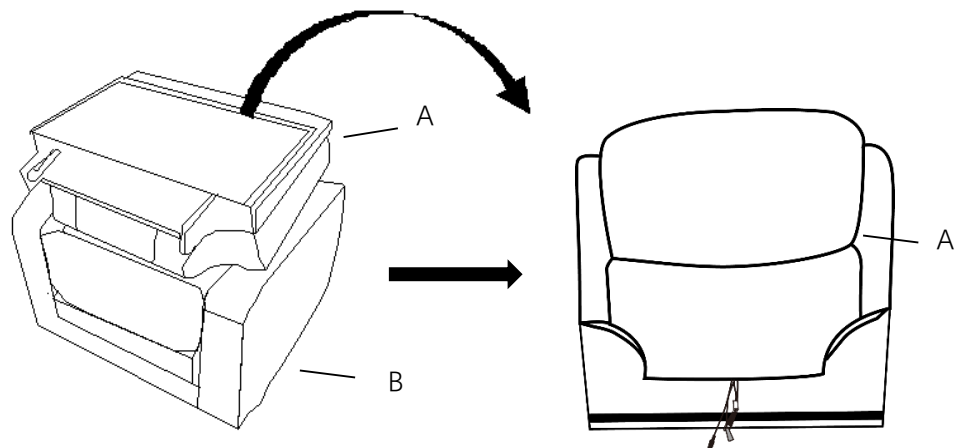

Take out the Chair Backrest(A) from Chair Base with Footrest(B).

Step 2

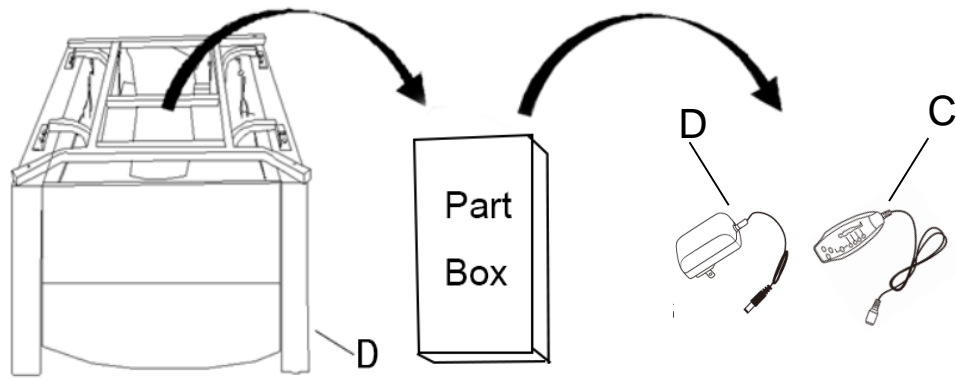

Take out the accessories box from the bottom of the mechanism. Then take out the Massage Remote(C) and Plug(D) from the accessories package.

Step 3

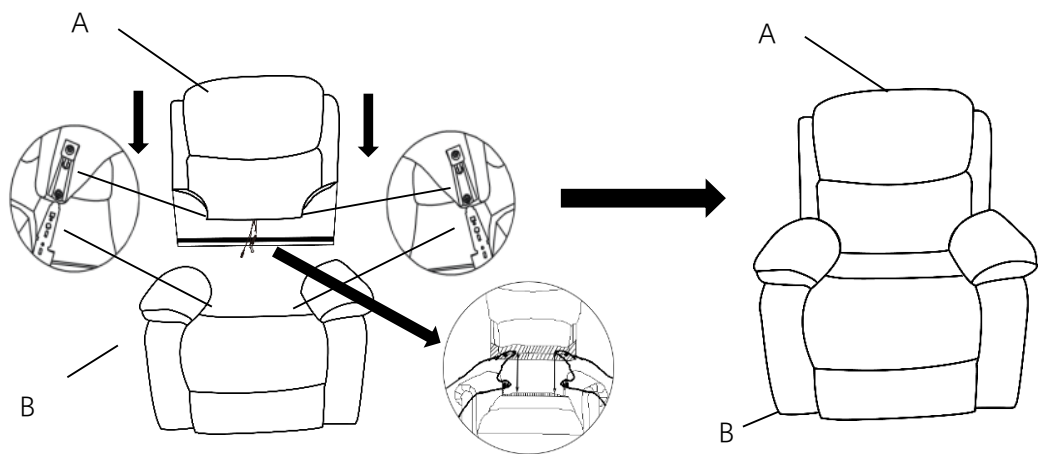

With assistance from your adult partner, hold up the fully assembled Chair Backrest(A), stand behind the chair. Insert the small metal arms on the sides of the Chair Backrest(A) into the prefabricated slide lock gadget on the Chair Base with Footrest(B) as shown above. Firmly but gently, push the Chair Backrest(A) downwards until the Backrest is fully slotted and locked into position. Stick the Velcro of the back on the seat.

Step 4

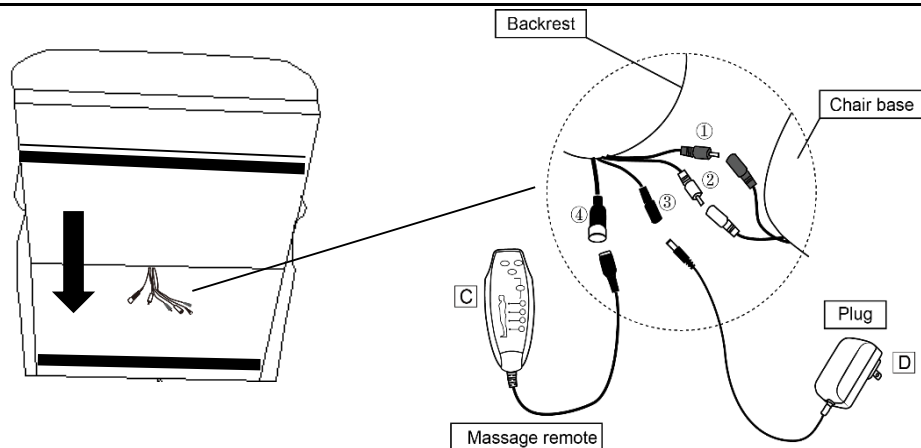

No.1 and No.2 wire connect with the Chair Backrest(A) and Chair Base(B).
 (Two same color wires connect)
 Connect the Massage Plug(D) to No.3 wire at the back of the Chair.
 Then connect the Massage Remote(C) to the No.4 wire at the back of the Chair.
 Smooth down the fabric flap on the Chair Backrest(A).
 Run your hands down both sides of the flap, from top to bottom, allowing the velcro tape to adhere to the flap under the seat of the chair.

Step5



Your Massage Chair is ready for use.
This Massage Chair can only be used on a flat, level surfaces.

User Instructions.

Massage Chair

Please read the Instruction Manual below carefully before use.

Supervise children, when they are using this Massage Chair.

To get into a reclined posture - To Recline backrest

Sit into the seat.
 Pull the trigger on the side to recline.

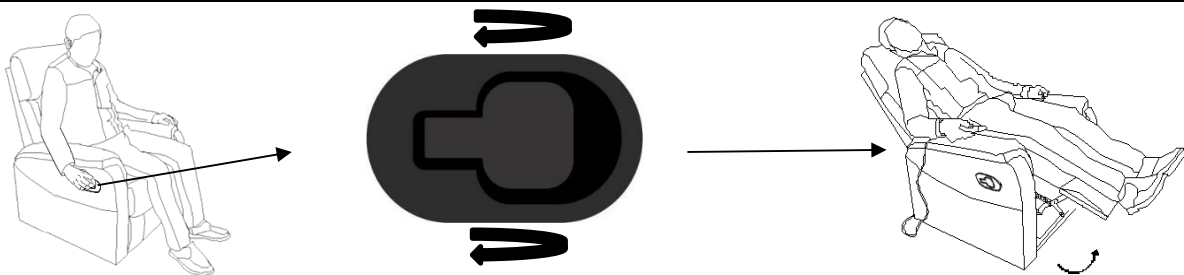

To get out of chair - Press the bottom of footrest with some strength (with feet) .

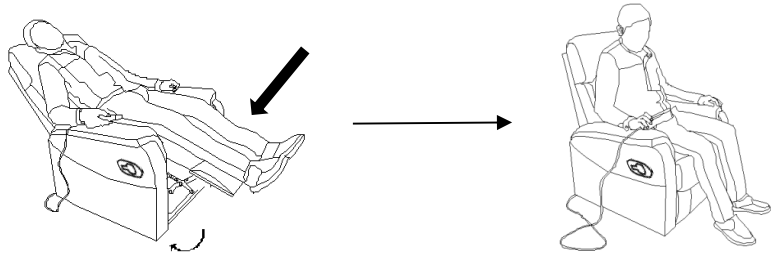

Use the button on the remote to activate the massage and heating function.

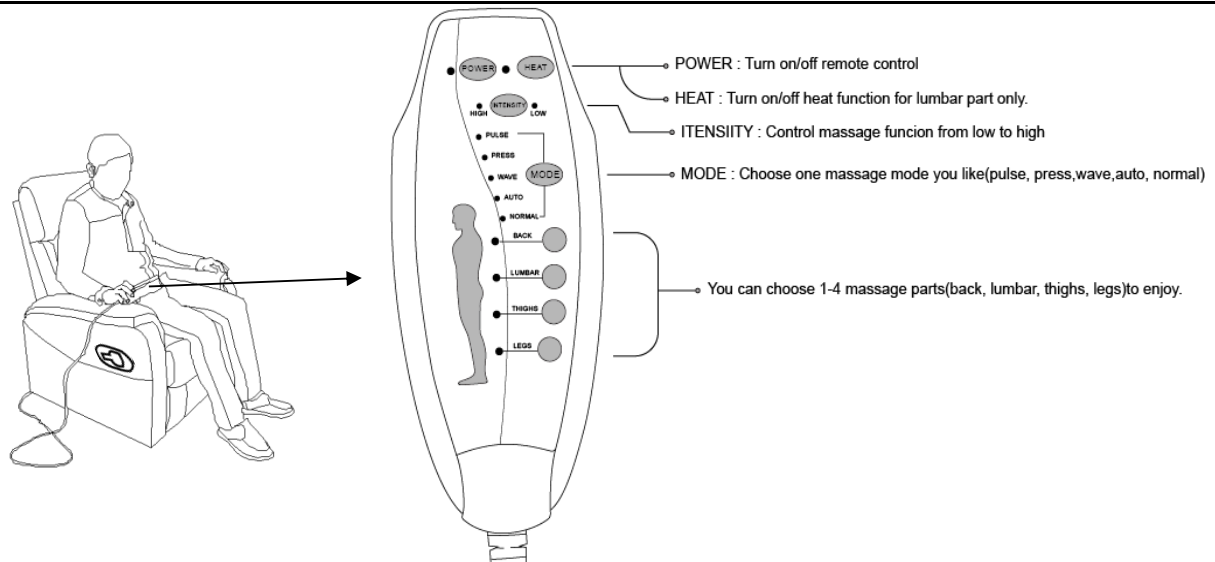

To Dissassemble your Massage Chair

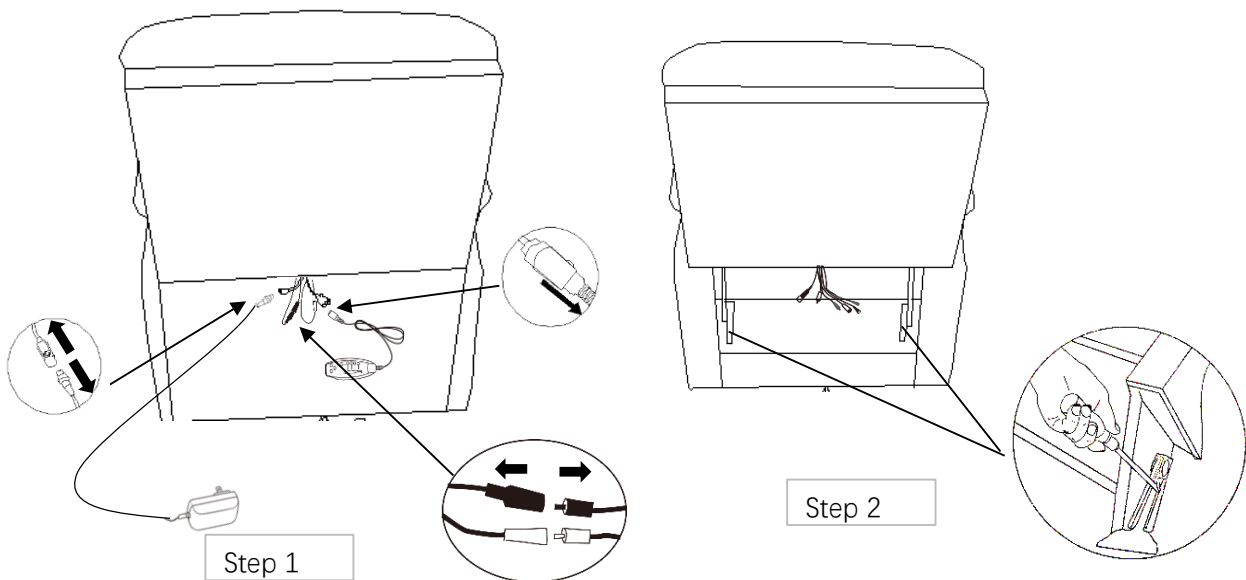

Step 1) Remove the same color wires from each other and the plug of the Massage Remote(C) and Plug(D).

Step 2) Release the locking mechanism from the prefabricated slide lock gadget with a Screwdriver, first on the right side, and repeat the process with the left side.

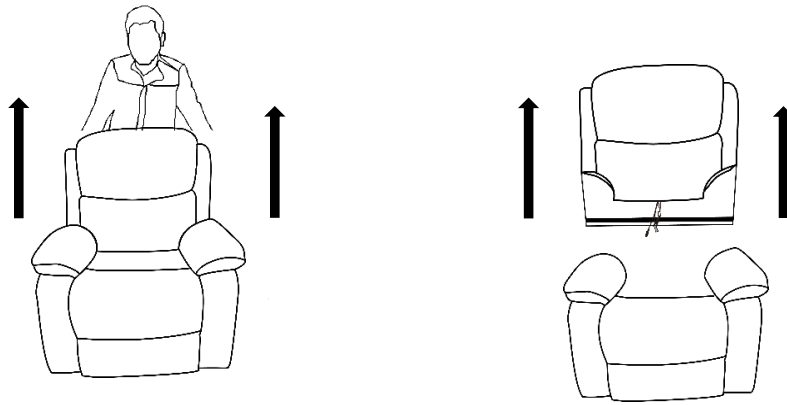

To Remove the Chair Backrest(A):

Open the back flap on the right side. Pull up the right side of Chair Backrest(A). Then repeat the process to pull up the left side of Chair Backrest(A).

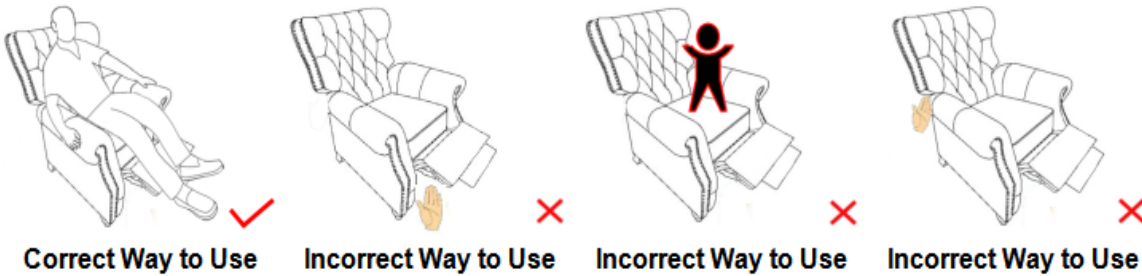

Do not allow children to play on the chair.
 Always leave the chair in an upright and closed position after use!
 Keep hands and feet clear of the footrest mechanism and ANY gaps.
 Only the occupant should operate the chair.

Care & Maintenance



- Furniture may scratch floors. We recommend using furniture pads to protect your floors.



- Do not put hot items directly on furniture surface.



- Do not clean furniture with harsh cleansers or polish.



- Do not place furniture under direct sunlight.



- Do not place furniture near heating or cooling vents.



- Do not write on furniture without a padded barrier to protect the surface.



- Do not place furniture outside . For indoor use only.



- Not for commercial use. For residential use only.



- Stains may be removed with mild soap solution and damp cloth.



- Children should not climb or jump on the furniture.



- Dust and pick-up spills using a clean, non-colored, lint-free cloth.

Questions & Answers about Proposition 65

• What is Proposition 65?

Proposition 65 requires businesses to provide warnings to Californians about significant exposures to chemicals that cause cancer, birth defects or other reproductive harm. These chemicals can be in the products that Californians purchase, in their homes or workplaces, or that are released into the environment. By requiring that this information be provided, Proposition 65 enables Californians to make informed decisions about their exposures to these chemicals.

Proposition 65 also prohibits California businesses from knowingly discharging significant amounts of listed chemicals into sources of drinking water.

Proposition 65 requires California to publish a list of chemicals known to cause cancer, birth defects or other reproductive harm. This list, which must be updated at least once a year, has grown to include approximately 900 chemicals since it was first published in 1987.

• What types of chemicals are on the Proposition 65 list?

The list contains a wide range of naturally occurring and synthetic chemicals that include additives or ingredients in pesticides, common household products, food, drugs, dyes, or solvents. Listed chemicals may also be used in manufacturing and construction, or they may be byproducts of chemical processes, such as motor vehicle exhaust.

• What does a warning mean?

If a warning is placed on a product label or posted or distributed at a workplace, a business, or in rental housing, the business issuing the warning is aware or believes that it is exposing individuals to one or more listed chemicals.

By law, a warning must be given for listed chemicals unless the exposure is low enough to pose no significant risk of cancer or is significantly below levels observed to cause birth defects or other reproductive harm.

• Where can I get more information on Proposition 65?

If you have specific questions on the administration or implementation of Proposition 65, you can contact OEHHA's Proposition 65 program at P65.Questions@oehha.ca.gov, or by phone at (916) 445-6900.