

# Installation & Assembly

## DIMENSIONS

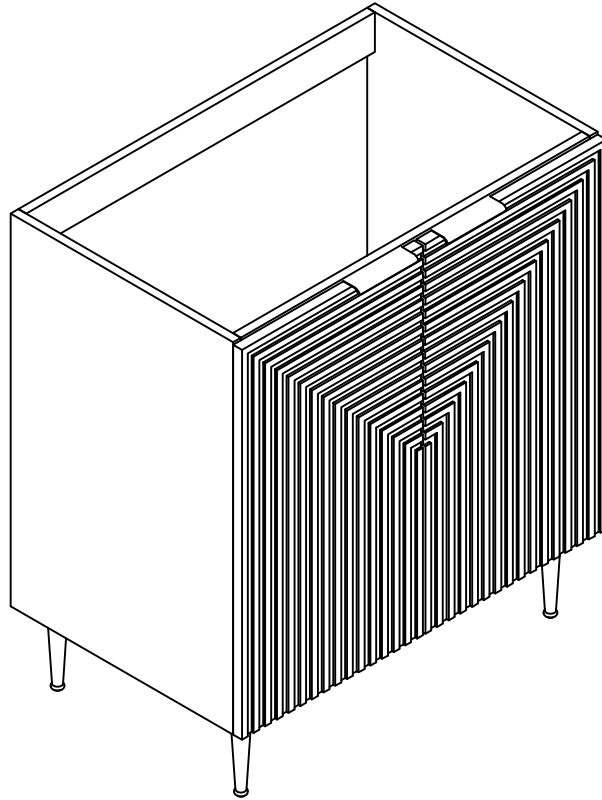

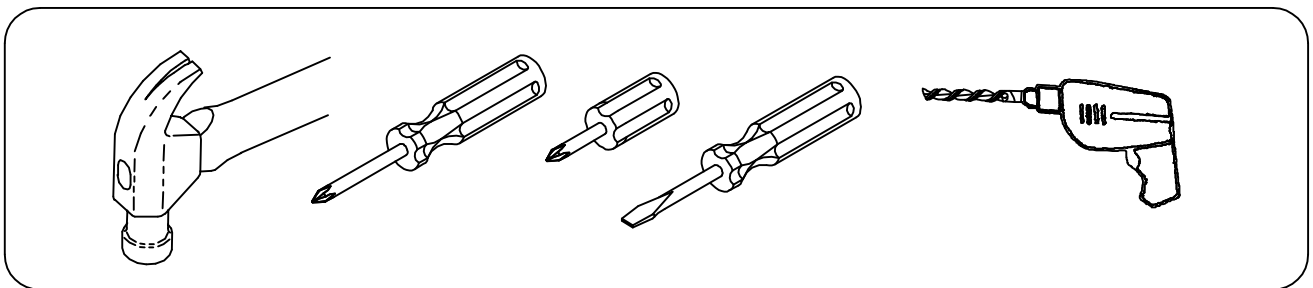





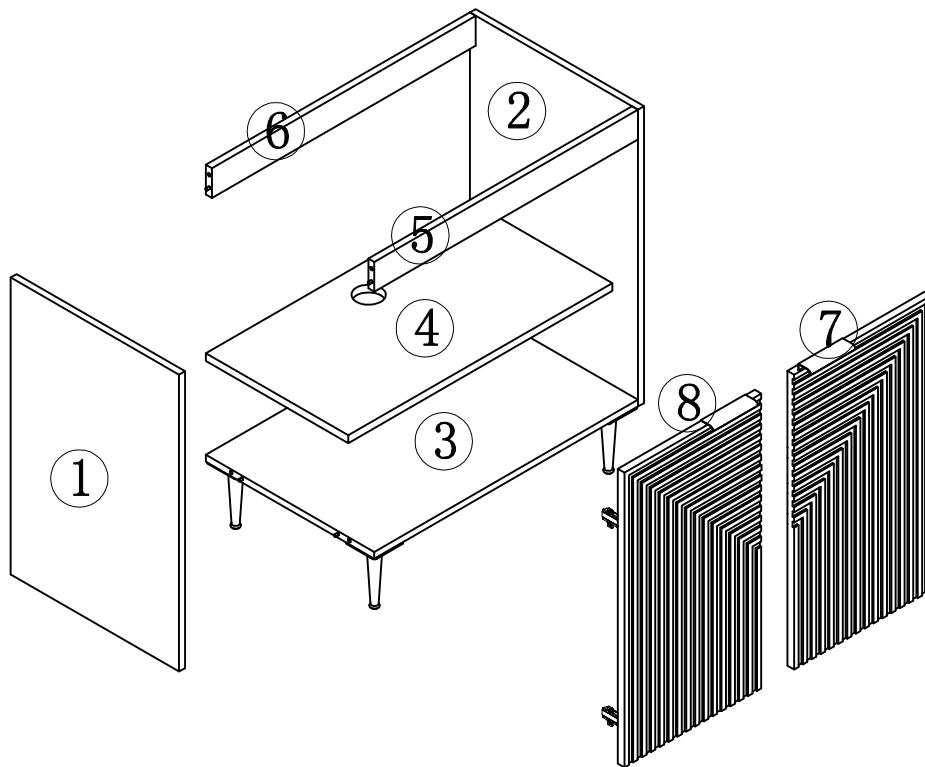





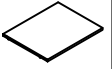







## YOU MAY NEED (NOT SUPPLY)





# ASSEMBLY DIAGRAM



PARTS LIST					
PARTS LIST					
NO	DESCRIPTION	QTY	NO	DESCRIPTION	QTY
①	Left side panel 	1	⑥	Rear baffle 	1
②	Right side panel 	1	⑦	Right door panel 	1
③	Bottom panel 	1	⑧	Left door panel 	1
④	Clapboard 	1			
⑤	Front drawbar 	1			

PARTS LIST					
HARDWARE LIST					
NO	DESCRIPTION	QTY	NO	DESCRIPTION	QTY
A	Three-in-one eccentric wheel 	8	G	4*16mm screw 	40
B	Three-in-one connecting rod 	8	H	4*12mm screw 	4
C	Three-in-one sticker 	8	I	Door handle 	2
D	8*40mm wood dowel pins 	8	J	Aluminum alloy leg 	4
E	Two-in-one lock handle 	4	K	Pipe Plug 	1
F	Two-in-one screws 	4	L	Door hinges 	4
CAUTION: Please confirm the parts list before installation					

# STEP 1

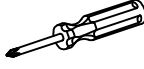
HARDWARE LIST		
Three-in-one connecting rod B  8PCS	Two-in-one screws F  4PCS	

1. Put the three-in-one connecting rod in the 10mm hole of the following panels and tighten them with a cross screwdriver or an electric tool.

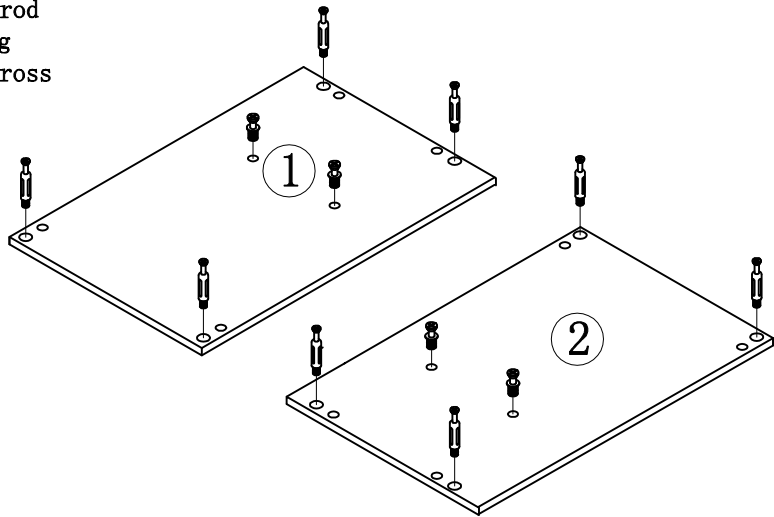
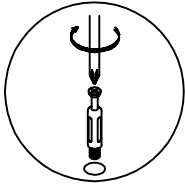

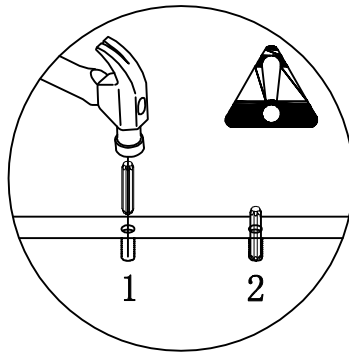

# STEP 2

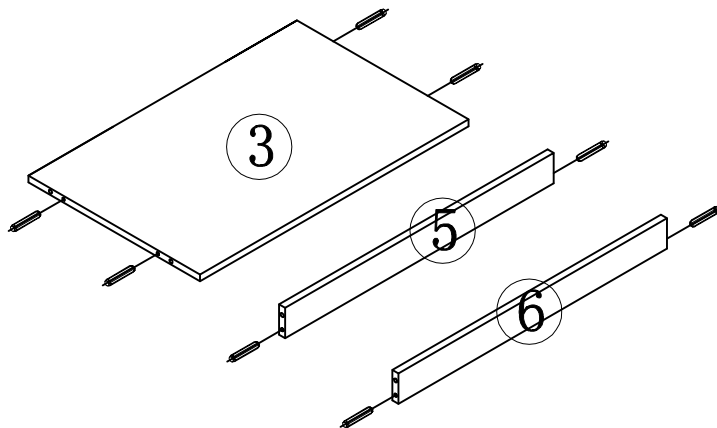

1. Strike the 08\*40mm wood dowel pin into the 8m hole of the above panels with an iron hammer. Please note that the hole of the three-in-one connecting rod should also be 8mm. The hole of the three-in-one connecting rod connects to the hole of 15mm three-in-one eccentric wheel.



HARDWARE LIST	
8*40mm wood dowel pins D  8PCS	

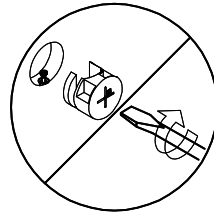
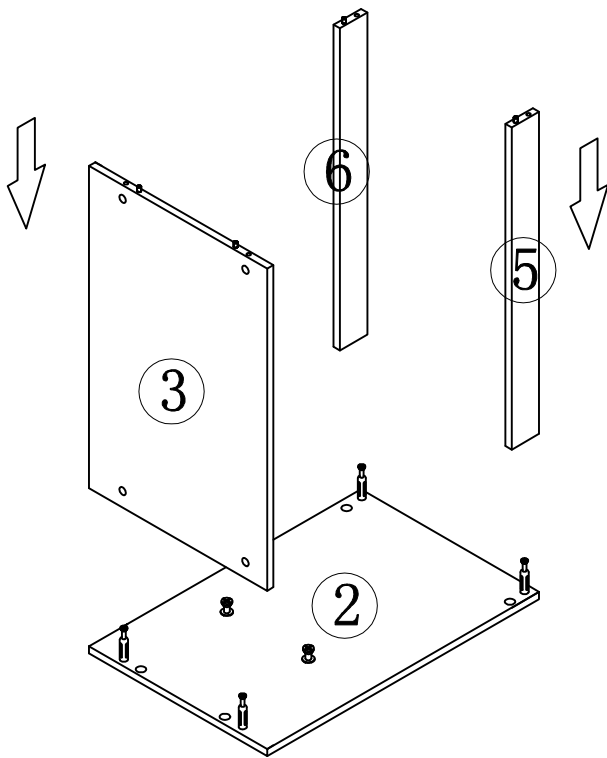

# STEP 3

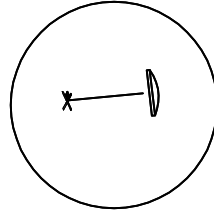

1. Connect No. 3-5-6 panel to No. 2 panel tightly with the three-in-one eccentric wheel.



2. Cover the mounting hole of the eccentric wheel with a three-in-one sticker.

HARDWARE LIST		
Three-in-one eccentric wheel A  4PCS	Three-in-one sticker C  4PCS	

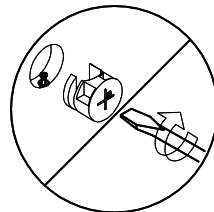
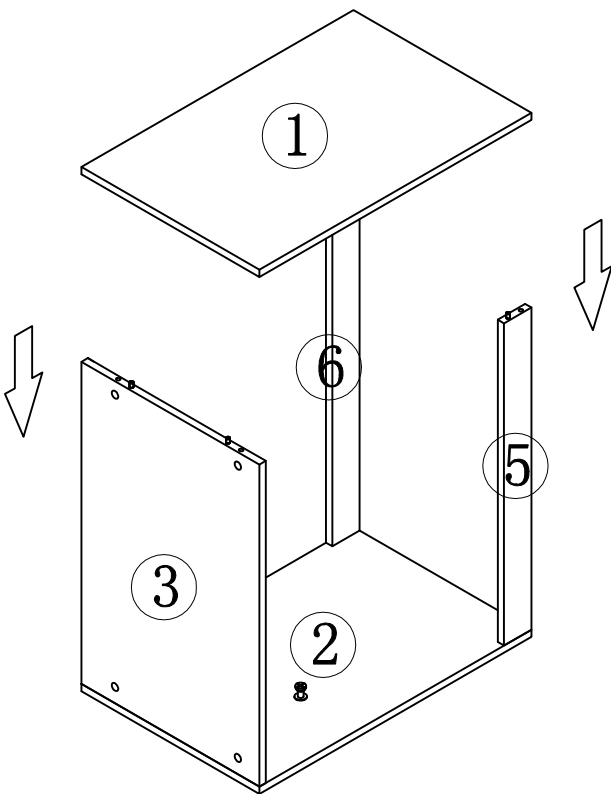

# STEP 4

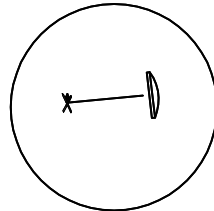

1. Connect No. 1 panel to No. 3-5-6 panel tightly with the three-in-one eccentric wheel.





2. Cover the mounting hole of the eccentric wheel with a three-in-one sticker.

HARDWARE LIST		
Three-in-one eccentric wheel A  4PCS	Three-in-one sticker C  4PCS	

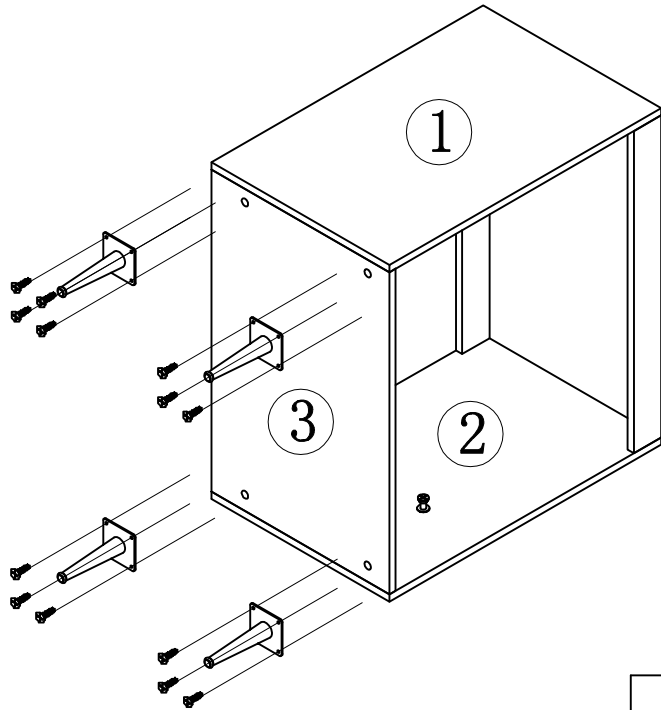
# STEP 5





Use 4\*16 screws to fix the aluminum alloy feet

HARDWARE LIST		
4*16mm screw	Aluminum alloy leg	
G  16PCS	J  4PCS	

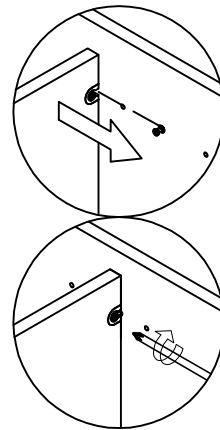
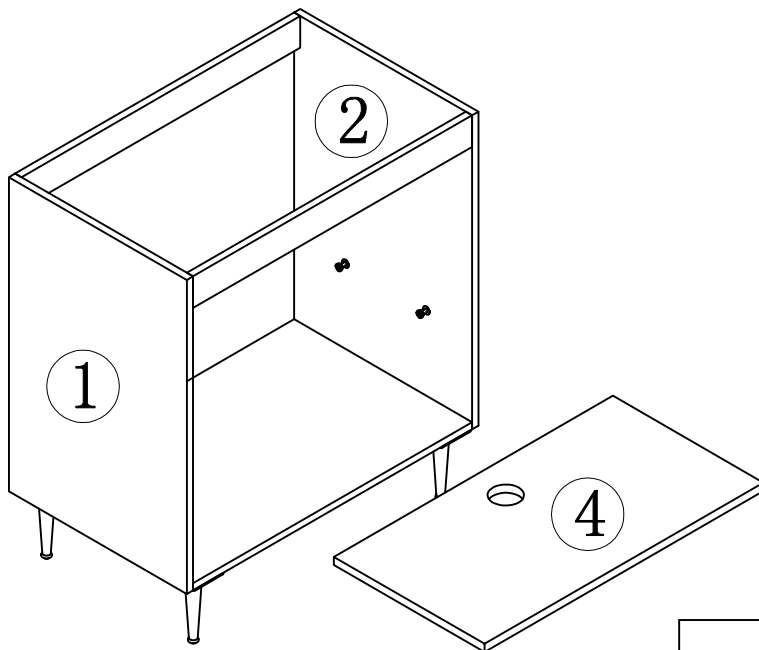
# STEP 6



Fix the two-in-one lock handle on No.4 plate and put it in the cabinet. Put the pipe plug on No. 4 plate

HARDWARE LIST		
Two-in-one lock handle	Pipe Plug	
E  4PCS	K  1PCS	

# STEP 7

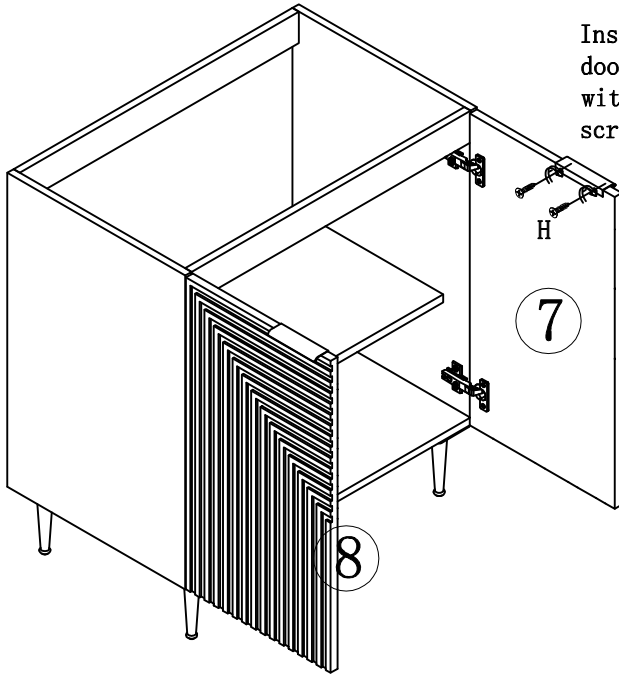

Install the door handle with 4\*12mm screws.

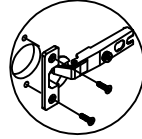

1. Install the hinge cup to the door panel with 4\*16mm screws.

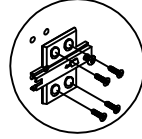

2. Install the hinge to the side panel with 4\*16mm screws.

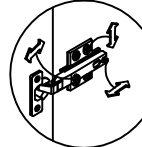

4. Adjust the door panel clearance.

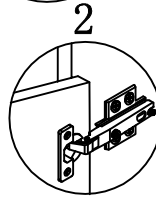
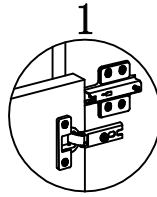

3. Install the hinge cup on the door panel to the hinge of the side panel.

HARDWARE LIST				
4*16mm screw	Door hinge	Door handle	4*12mm screw	
G  24PCS	L  4PCS	I  2PCS	H  4PCS	

## Hinge/Door Adjustment and Realignment

If adjustment or realignment is needed, follow the instructions provided in the following chart.

Vertical adjustment

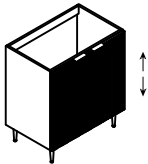

1. Loosen screws

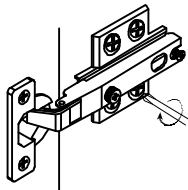

2. Adjust hinge

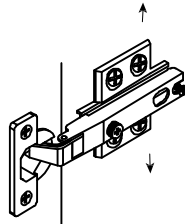

3. Tighten screws

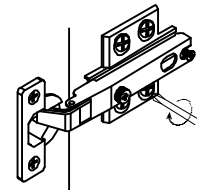

Horizontal adjustment

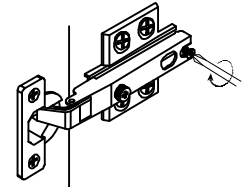
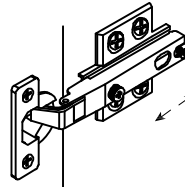
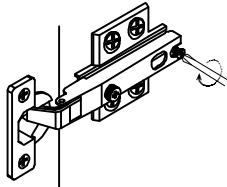
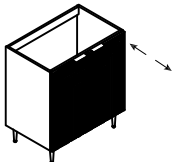

Door gap adjustment

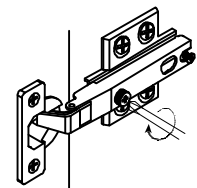
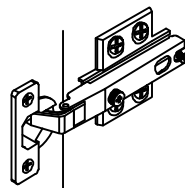
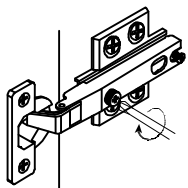
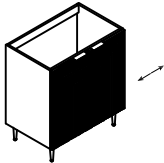



**Choking hazard-Small Parts :** This unit contains small parts, not for children under 3 years.

**Tip-over hazard :** Secure finished unit to wall stud using L-Bracket and wall screw (#10\*1.5"W/out provided). If a wall stud is not neccessible , Consault your local hardware store for appropriate mounting hardware . Failure to properly install will result in product collapse or tip-over. Serious injury can occur .