

# Bed Frame

---

Dimension: UK: 196\*145.5\*115.5cm

FR: 196\*149\*115cm

# Assembly Guide

## Tip!

Do check for all the components and screws listed in this guide before putting things together. If any part is missing, contact us for the missing part.

## Return Policy

Your satisfaction is our top priority. If our product fails to satisfy you, please let us know how we can make things right for you. Our trained customer care team can handle most concerns and assist you with any questions you may have. Simply shoot them a message with your order number and question. To be eligible for a full-refund return, the item must be in pristine condition, in the original packaging, with all of the shipped components intact and not yet assembled, and with the item's unique proof of purchase.

## Trouble shooting:

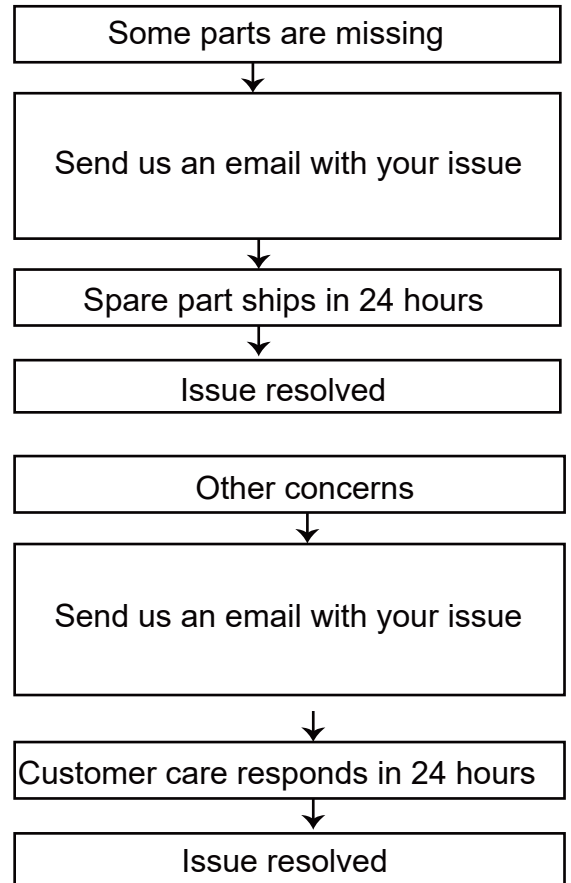

We run our own manufacturer, so rest assured about the quality consistency.

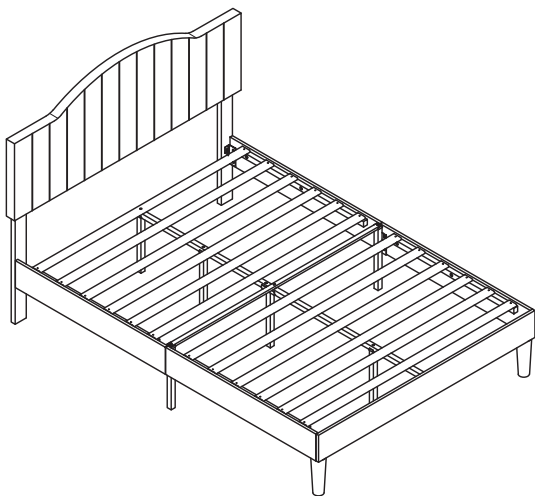

Item Description: Bed Frame

# Montageanleitung

## Tipp!

ÜBERPRÜFEN Sie alle in dieser Anleitung aufgeführten Komponenten und Schrauben, bevor Sie die Bauteile zusammenbauen. Sollte ein Bauteil fehlen, kontaktieren Sie uns, um Ersatz zu erhalten.

## Rückgaberrichtlinie

Ihre Zufriedenheit ist unsere oberste Priorität. Wenn Sie mit unserem Produkt nicht zufrieden sind, lassen Sie uns bitte wissen, wie wir das Problem für Sie lösen können. Unser geschultes Kundenbetreuungsteam kann die meisten Anliegen klären und Ihnen bei all Ihren Fragen weiterhelfen. Senden Sie uns einfach eine Nachricht mit Ihrer Bestellnummer und Ihrer Anfrage. Um eine vollständige Rückerstattung zu erhalten, muss der Artikel in einwandfreiem Zustand sein und sich in der Originalverpackung mit allen gelieferten und noch nicht zusammengebauten Komponenten befinden. Zudem ist ein eindeutiger Kaufnachweis erforderlich.

## Problemlösung:

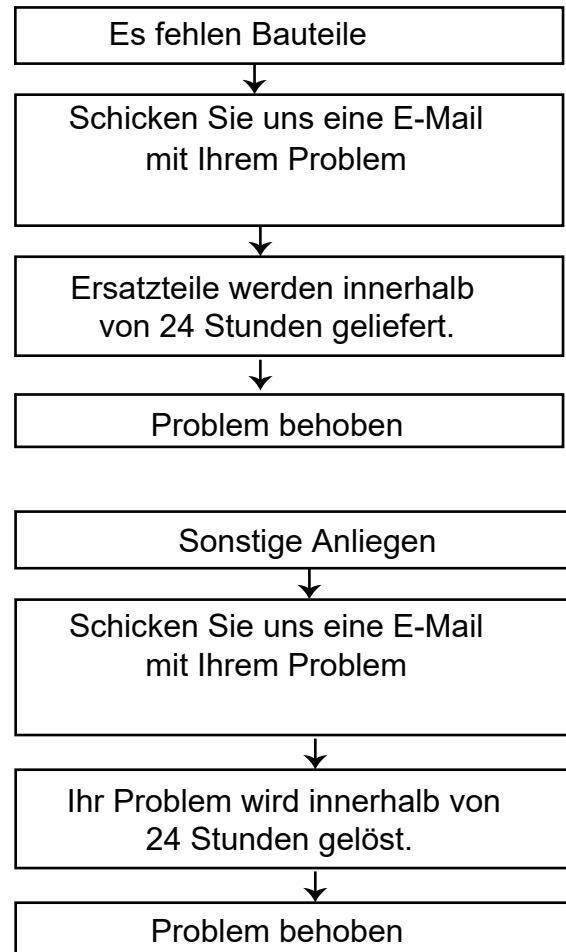

Wir stellen unsere Artikel selbst her, sodass Sie sich auf gleichbleibende Qualität verlassen können.

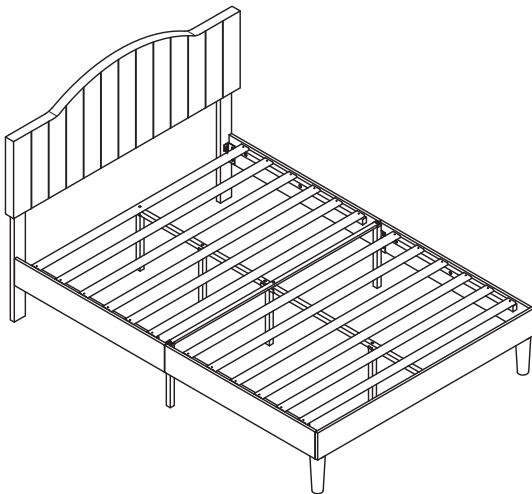

Item Description: Bettrahmen

# Guide de montage

## Attention !

Vérifiez la présence de l'ensemble des éléments et vis énumérés dans ce guide avant de procéder au montage. Si une pièce venait à manquer, envoyez-nous un e-mail pour nous en informer.

## Politique de retour

Votre satisfaction est notre priorité absolue. Si notre produit ne vous donne pas entière satisfaction, n'hésitez pas à nous faire savoir ce que nous pouvons faire pour améliorer la situation. Notre équipe d'assistance à la clientèle qualifiée est en mesure de résoudre la plupart de vos problèmes et de répondre à toutes vos questions. Il vous suffit de leur envoyer un message en indiquant votre nu numéro de commande et votre question. Pour pouvoir bénéficier d'un remboursement intégral, l'article doit être en parfait état, dans son emballage d'origine, avec tous les composants expédiés intacts et non encore assemblés, et avec la preuve d'achat de l'article

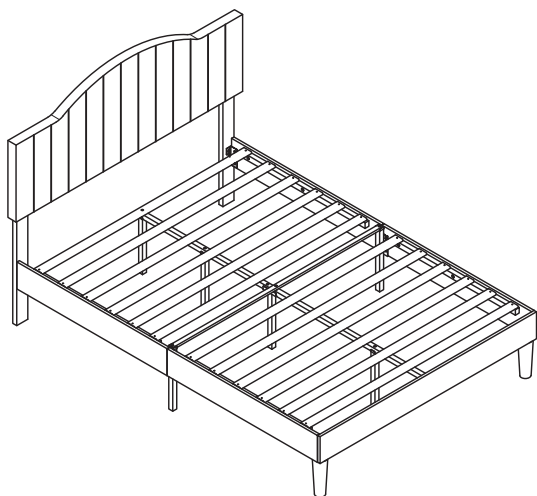

Item Description:           Cadre de lit          

## Dépannage :

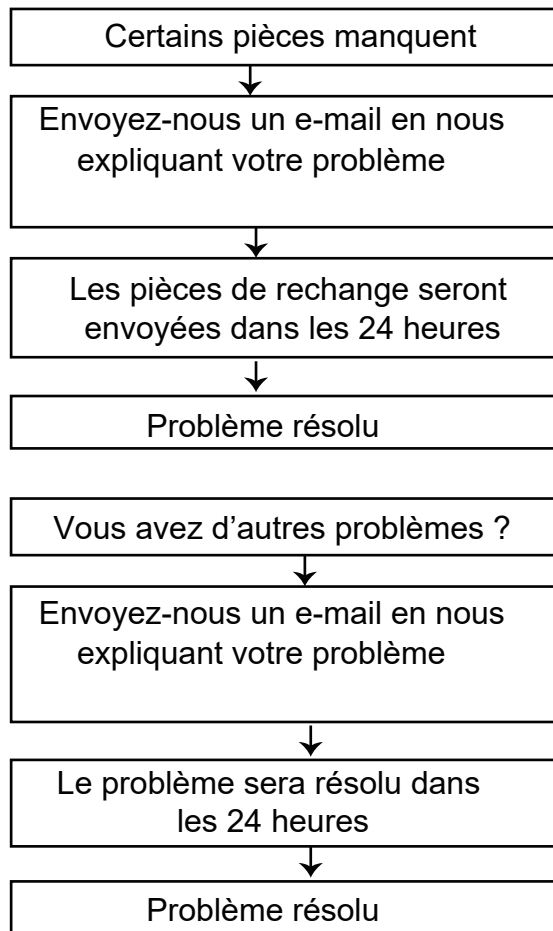

Nous assurons notre propre fabrication donc soyez assuré de bénéficier d'une qualité constante.

# Guida all'assemblaggio

## Suggerimento!

Controllare tutti i componenti e le viti elencati in questa guida prima di assemblare il tutto. Se manca qualche parte, contattaci per le parti mancanti.

## Politica di reso

La vostra soddisfazione è la nostra massima priorità. Se il nostro prodotto non ti soddisfa, faccelo sapere e ti aiuteremo a risolvere il problema. Il nostro team di assistenza clienti qualificato può gestire la maggior parte delle preoccupazioni e assisterti per qualsiasi domanda tu possa avere. Inviaci semplicemente un messaggio con il tuo numero d'ordine e la tua richiesta. Per essere idoneo a un reso con rimborso completo, l'articolo deve essere in ottime condizioni, nella confezione originale, con tutti i componenti intatti e non ancora assemblati, e con una prova d'acquisto valida.

## Risoluzione dei problemi:

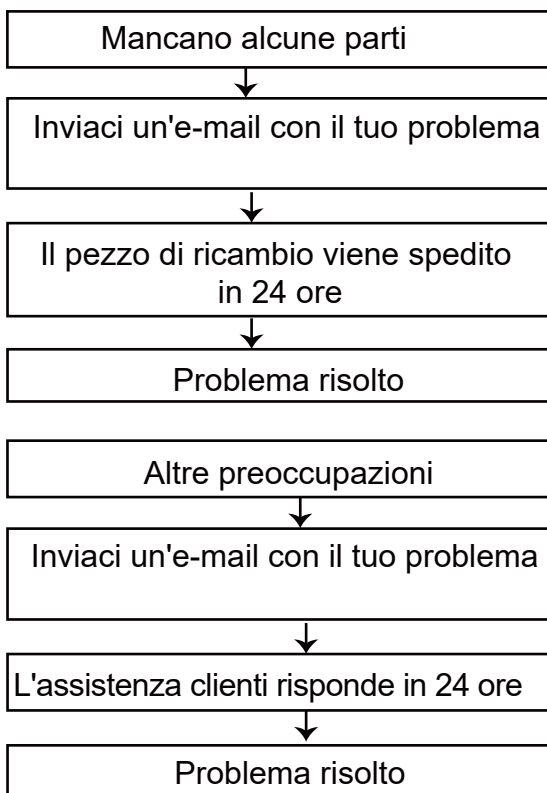

Gestiamo direttamente il nostro produttore, quindi puoi essere sicuro della qualità costante.

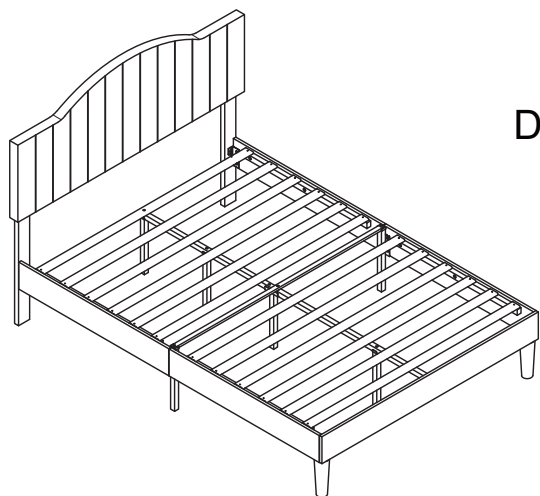

Descrizione dell'articolo: Telaio del letto

# Guía de montaje

## Consejo!

Verifique todos los componentes y tornillos enumerados en esta guía antes de ensamblar todo. Si falta alguna pieza, contáctanos para las piezas faltantes.

## Política de devoluciones

Su satisfacción es nuestra máxima prioridad. Si nuestro producto no le satisface, háganoslo saber y le ayudaremos a resolver el problema. Nuestro equipo de atención al cliente capacitado puede manejar la mayoría de las inquietudes y ayudarle con cualquier pregunta que pueda tener. Simplemente envíenos un mensaje con su número de pedido y su consulta. Para ser elegible para una devolución con reembolso completo, el artículo debe estar en impecable estado, en su embalaje original, con todos los componentes intactos, no ensamblado y con un comprobante de compra válido.

## Solución de problemas:

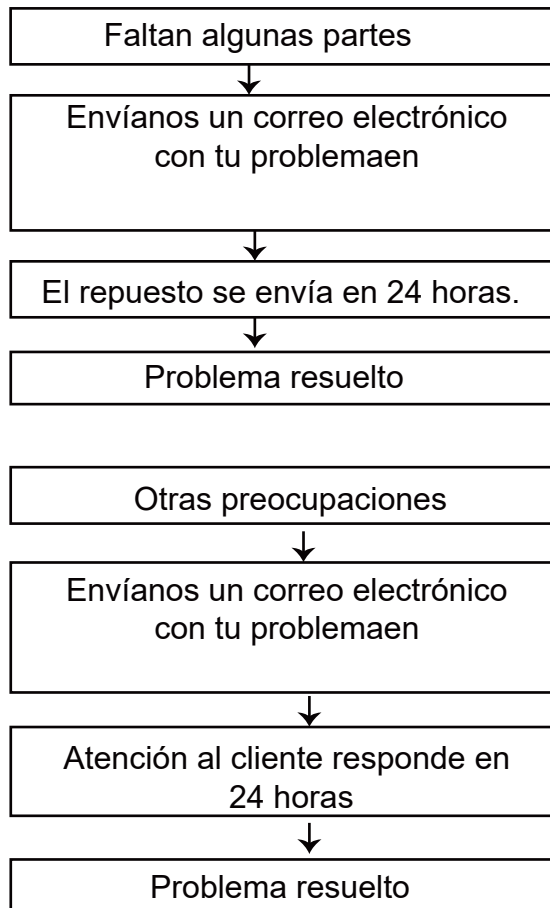

Gestionamos directamente con nuestro fabricante, así que puede estar seguro de la consistencia de la calidad.

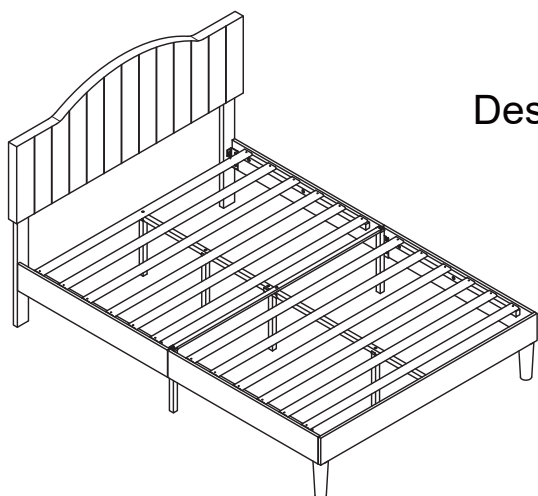

Descripción del artículo: Marco de la cama

# CAUTION!

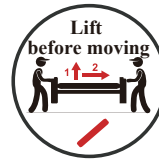
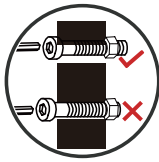

# ACHTUNG!

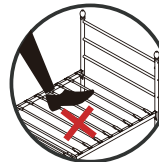
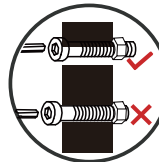

# ATTENTION !

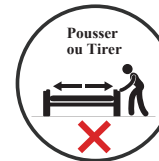
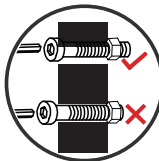

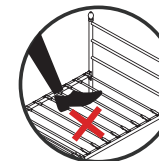
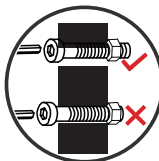

# CAUTELA!



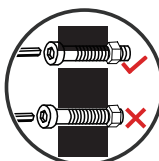

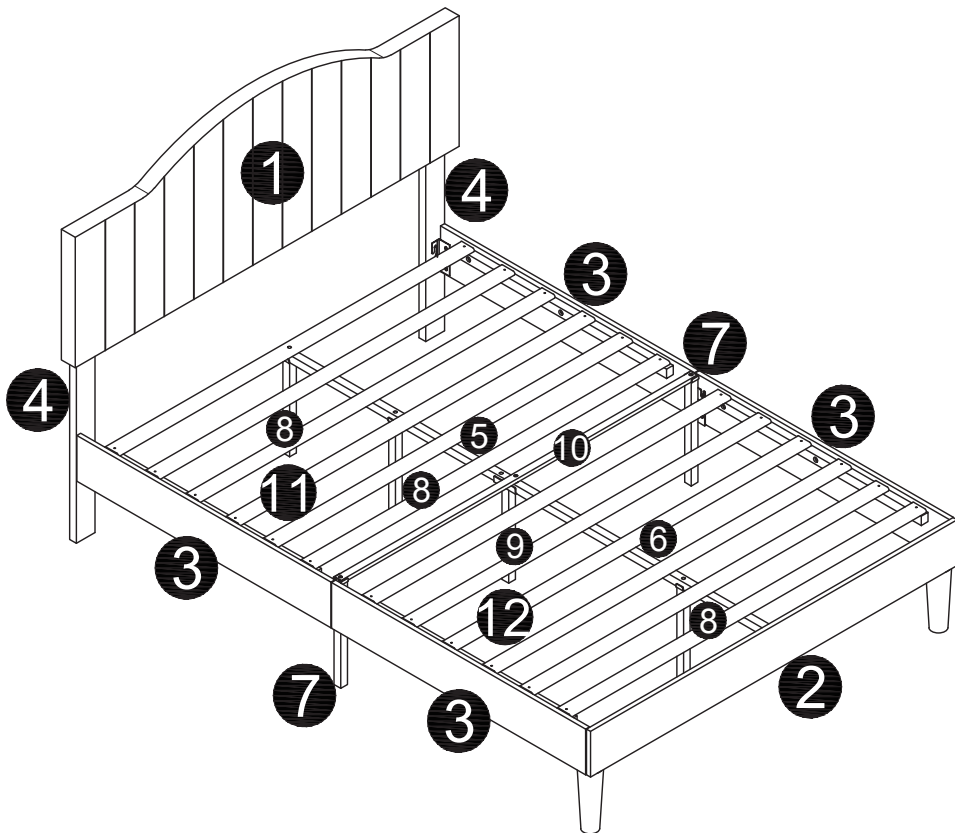
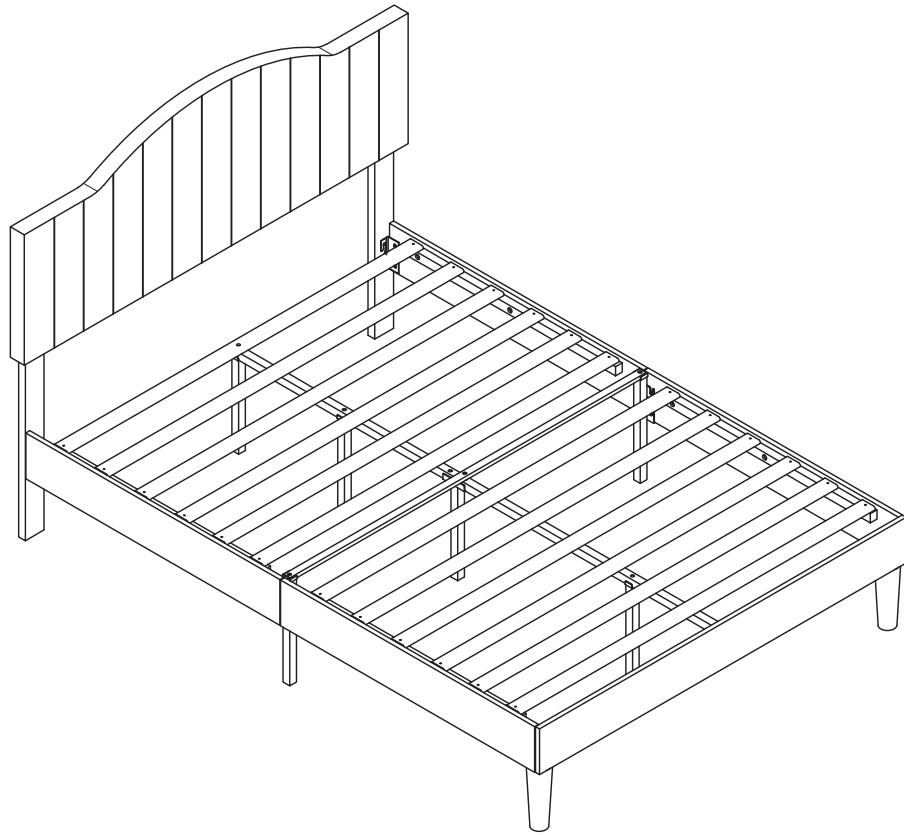

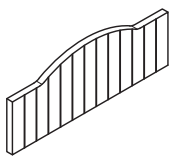
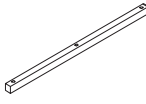
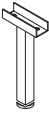
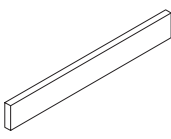
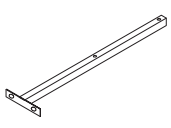
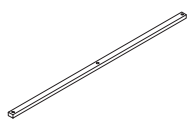
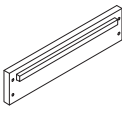
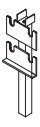
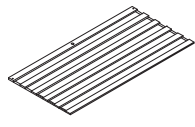

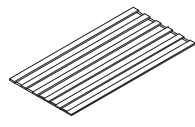

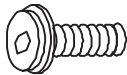
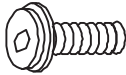
# PRECAUCIÓN !



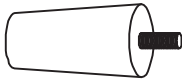

<p><b>1</b></p>		<p>1</p>	<p><b>5</b></p>		<p>1</p>	<p><b>9</b></p>		<p>1</p>
<p><b>2</b></p>		<p>1</p>	<p><b>6</b></p>		<p>1</p>	<p><b>10</b></p>		<p>1</p>
<p><b>3</b></p>		<p>4</p>	<p><b>7</b></p>		<p>2</p>	<p><b>11</b></p>		<p>1</p>
<p><b>4</b></p>		<p>2</p>	<p><b>8</b></p>		<p>3</p>	<p><b>12</b></p>		<p>1</p>

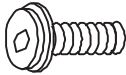
<p><b>A</b></p>	 <p>Bolt M8 x 25</p>	<p>2</p>	<p><b>A-1</b></p>	 <p>Preinstalled on components</p> <p>Bolt M8 x 25</p>	<p>4</p>
<p><b>B</b></p>	 <p>Bolt M8 x 45</p>	<p>4</p>	<p><b>C</b></p>	 <p>Bolt M8 x 45</p>	<p>5</p>
<p><b>D</b></p>	 <p>Spacer</p>	<p>4</p>	<p><b>E</b></p>	 <p>Angle iron</p>	<p>2</p>
<p><b>F</b></p>	 <p>Foot</p>	<p>2</p>	<p><b>G</b></p>	 <p>Angle iron</p>	<p>1</p>
<p><b>H</b></p>	 <p>Angle iron</p>	<p>1</p>	<p><b>I</b></p>	 <p>Allen Key M5</p>	<p>1</p>
<p><b>J</b></p>	 <p>Screw M4 x 25</p>	<p>2</p>	<p><b>L-1</b></p>	 <p>Preinstalled on components</p> <p>Bolt M8 x 18</p>	<p>22</p>

# Step 1

	Bx4		Dx4		Ix1
--	-----	--	-----	--	-----

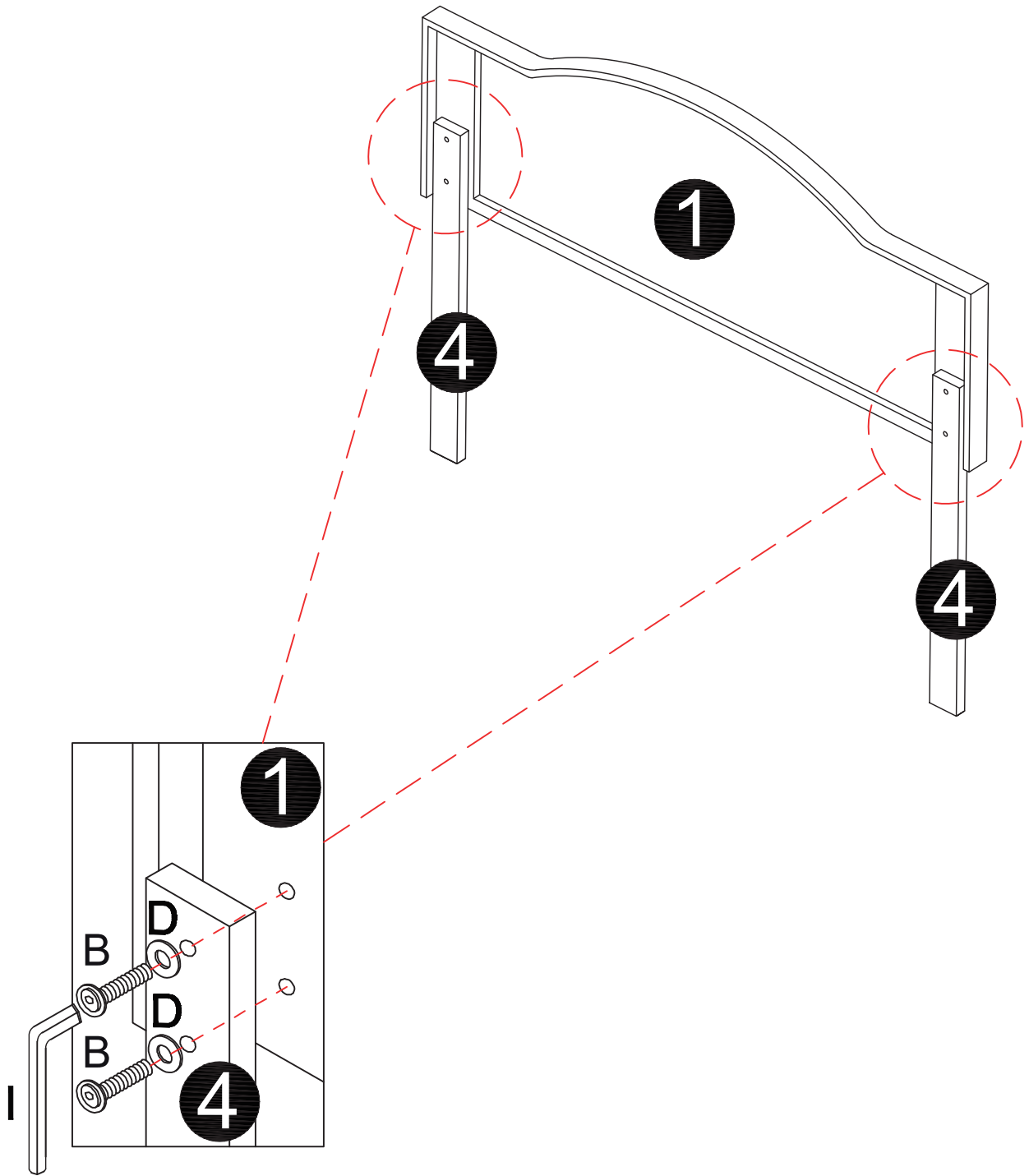

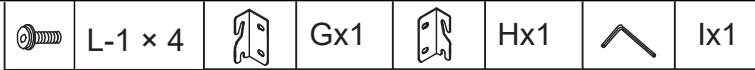

## Step 2

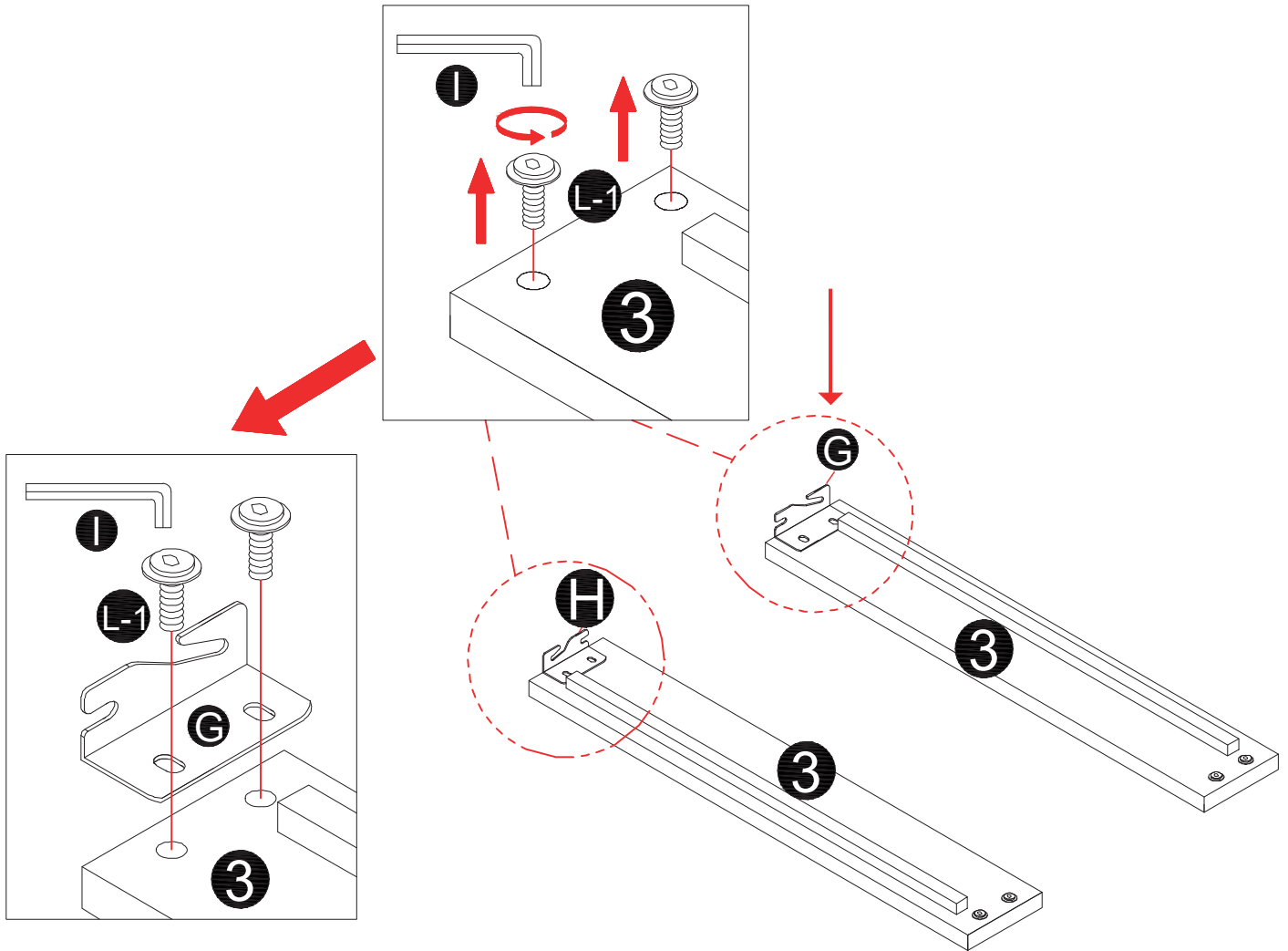

- Must Keep the Brackets Lay Toward the Ground.
- ★ Doit garder les supports posés vers le sol.
- ▲ Achten Sie auf die Richtung der Halterung.
- È necessario mantenere le staffe rivolte verso terra.
- ✱ Debe mantener los soportes hacia el suelo.



# Step 3

	L-1 x 8		7x2		1x1
--	---------	--	-----	--	-----

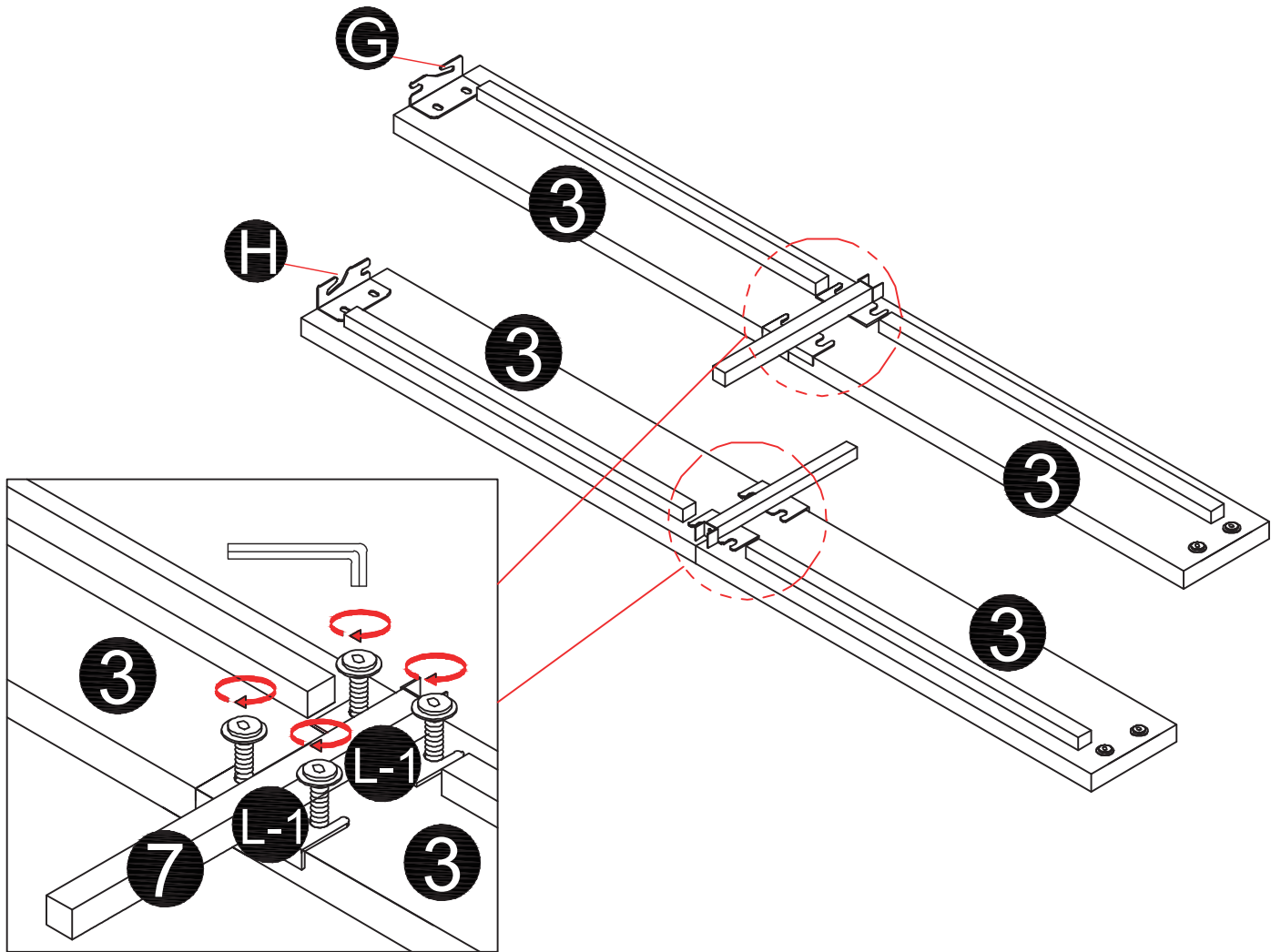

# Step 4

	A-1 × 4		1x1
--	---------	--	-----

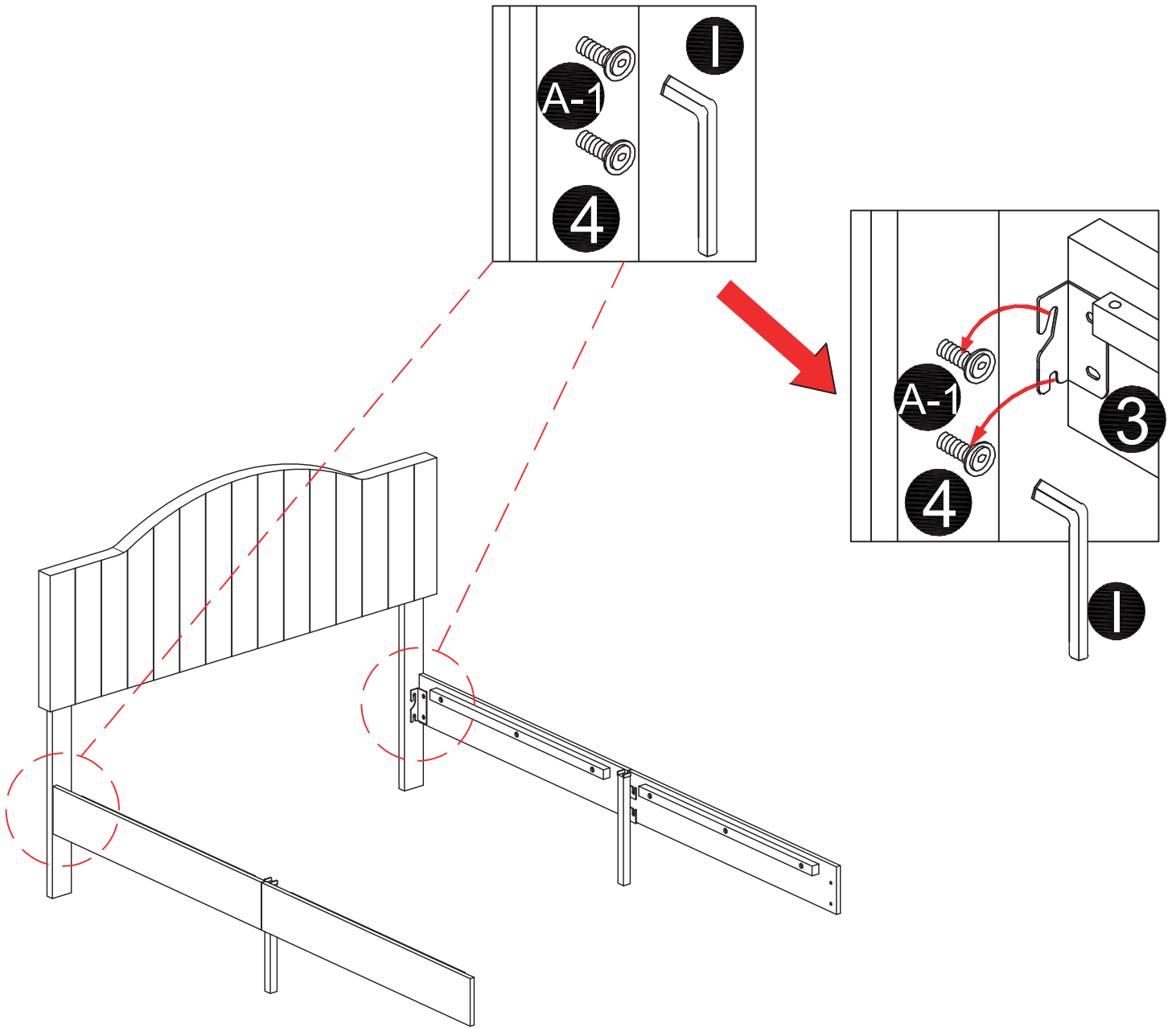

# Step 5



Ex2



Fx2

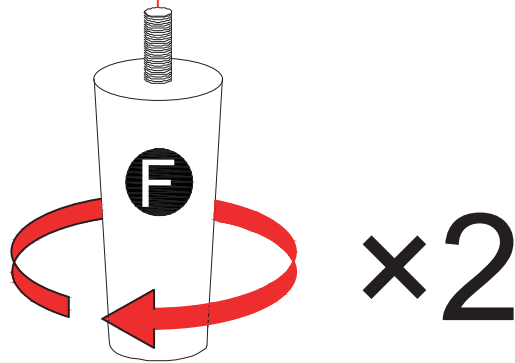
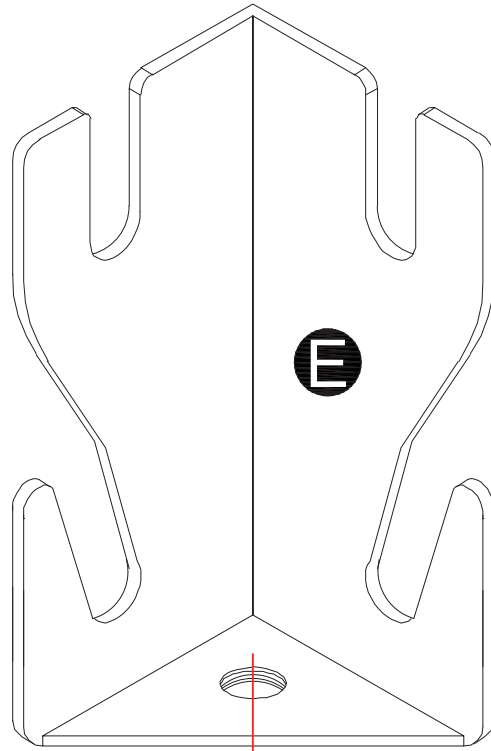

## Step 6





L-1 × 8

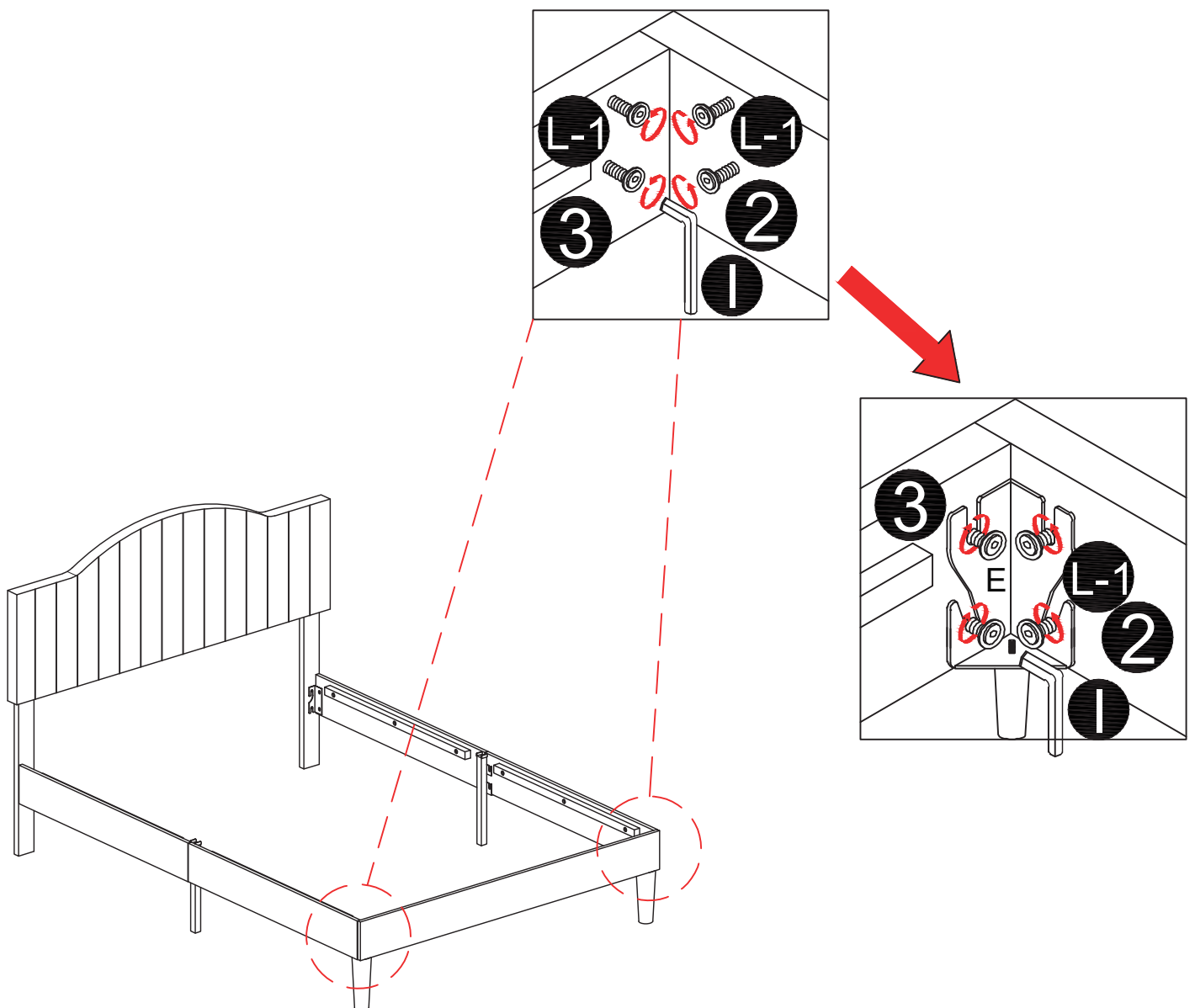

1 x 1

- Loose the Preinstalled 4 Screws for leg Installation, and Then Tighten Them Again
- ★ Desserrez les 4 vis préinstallées pour le pied Installation, puis resserrez-les.
- ▲ Lösen Sie die Originalschraube, installieren Sie das Bein, und ziehen Sie die Originalschraube.
- Allentare le 4 viti Preinstallate per l'installazione della gamba, quindi serrarle nuovamente.
- ✱ Afloje los tornillos Preinstalados para la instalación de las patas y luego apriételes nuevamente.



	Ax2		Cx2		Ix1
--	-----	---	-----	---	-----

# Step 7

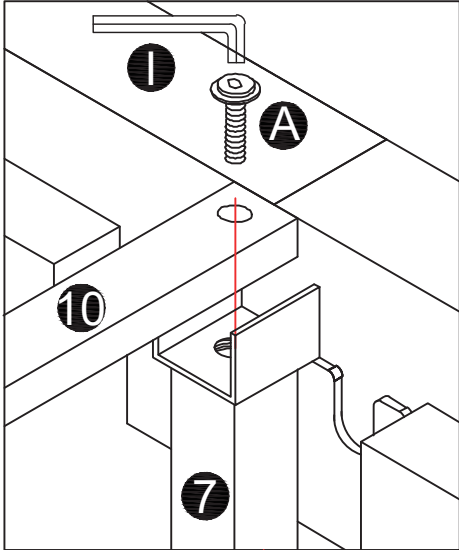

## 7-1

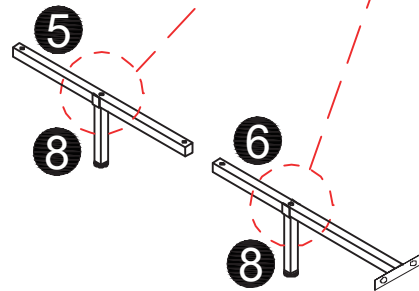
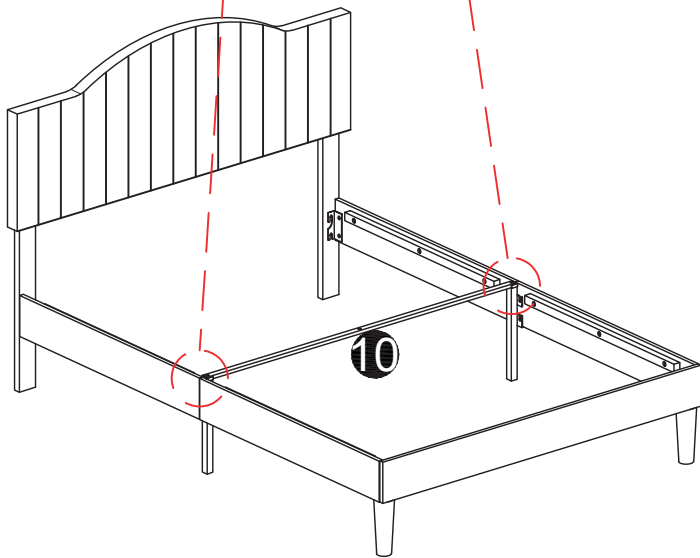
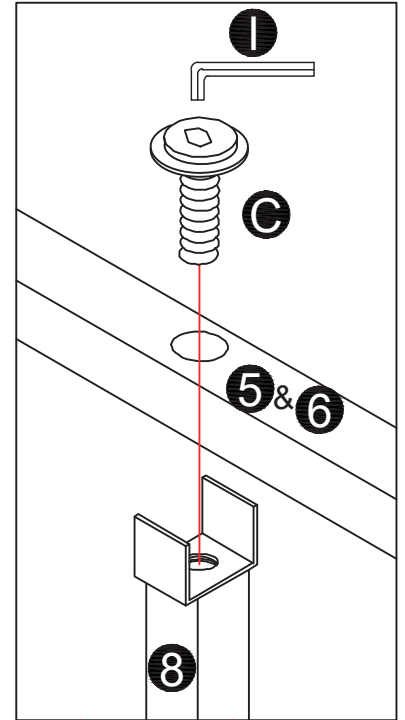

## 7-2



# Step 8

	L-1 x 2		Cx2		I x1
--	---------	--	-----	--	------

- Unscrew the original screw
- ★ Dévisser la vis d'origine
- ▲ Lösen Sie die Originalschraube
- Svitare la vite originale
- ✳ Desenrosque el tornillo original

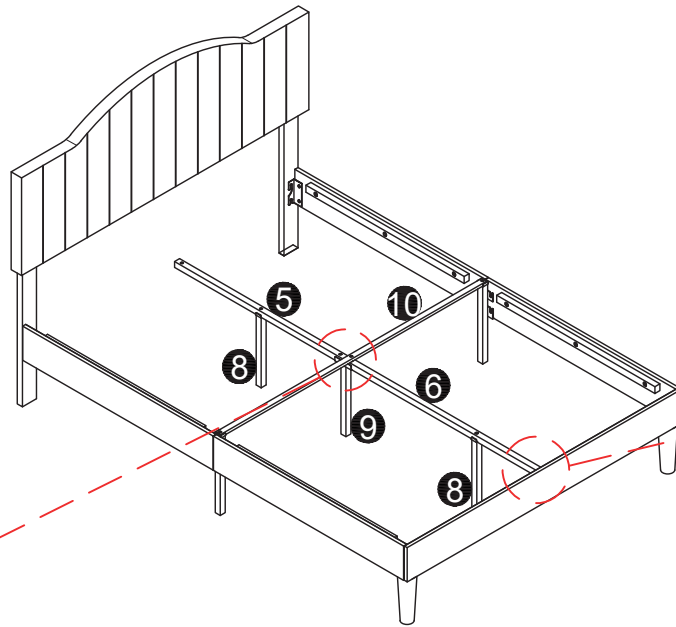

8-3

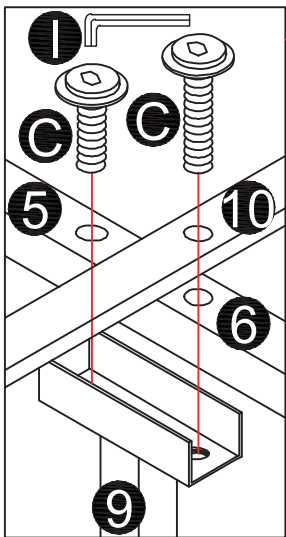

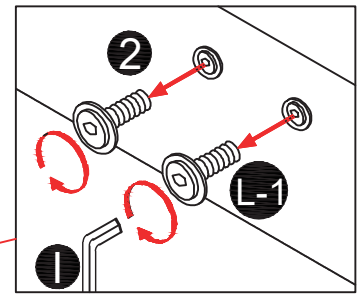

8-1

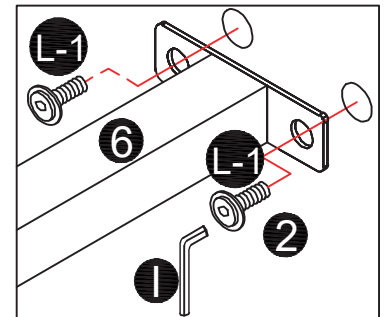

8-2 ↓



# Step 9

	Cx1		Jx2		lx1
--	-----	--	-----	--	-----

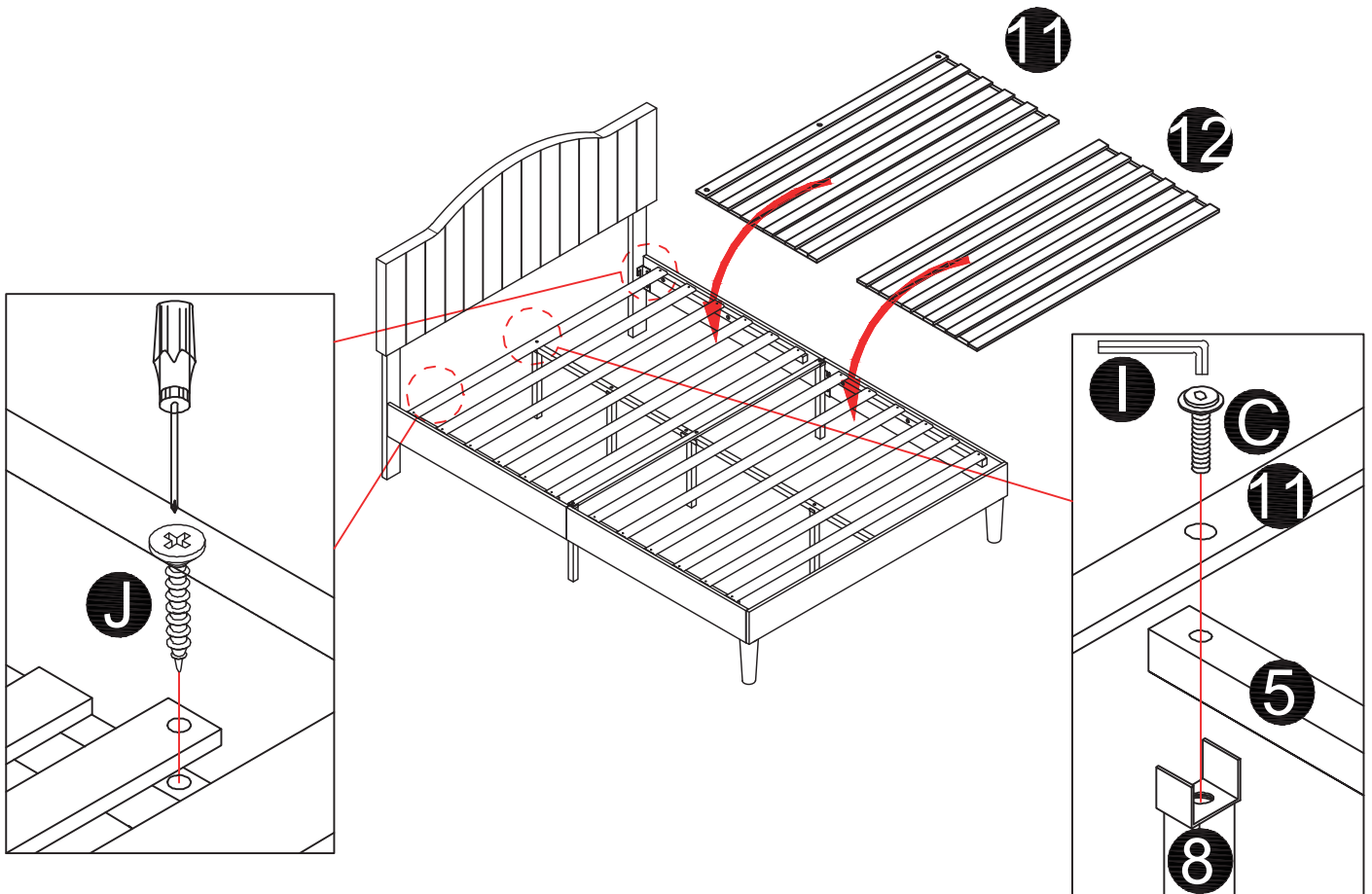

## Step 10

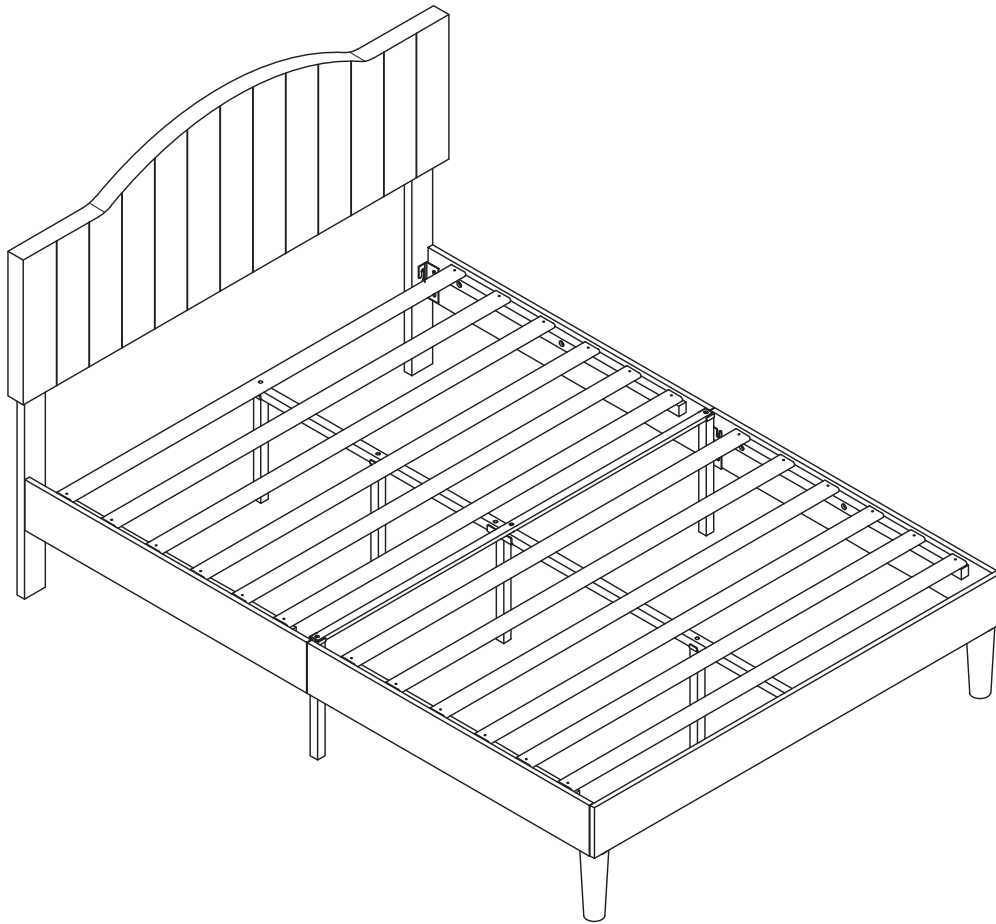

- Note: Now remember to double check all screws are properly fastened.
- ★ Hinweis: Vergessen Sie jetzt nicht, zu überprüfen, ob alle Schrauben richtig angezogen sind.
- ▲ Remarque : N'oubliez pas de vérifier que toutes les vis sont bien serrées.
- Nota: Ora ricordati di ricontrollare che tutte le viti siano correttamente fissate.
- ☀ Nota: Ahora recuerde volver a verificar que todos los tornillos estén correctamente apretados.