

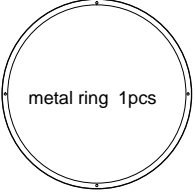

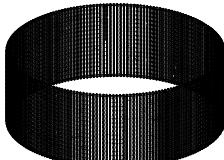







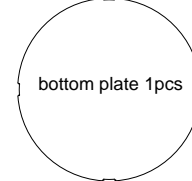

①		②	
③		⑥	
④		⑨	
⑤			
⑦		⑩	 X 1PCS
⑧		⑪	 X 1PCS
		⑫	 X 3PCS
		⑬	 X 3PCS
		⑭	 X 3PCS

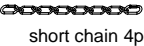

1. if the lines are uneven, can adjust them by hand
2. please adjust the profile left and right if it is not straight

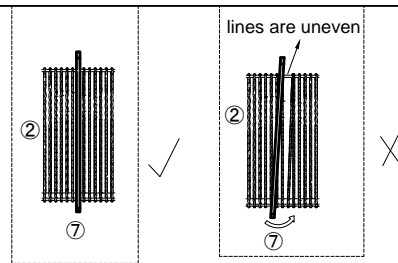
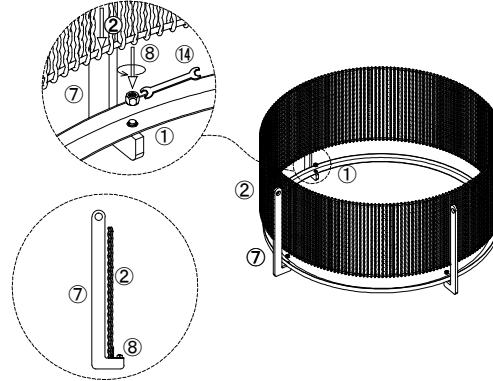

1. Use wrench ⑭ to install the metal profile ⑦ to the metal ring ① with lock nut ⑧, put the lampshade ② on the metal ring ①.
2. Adjust the lines of the lampshade to ensure an even distribution.(if the lines are uneven, can adjust them by hand)

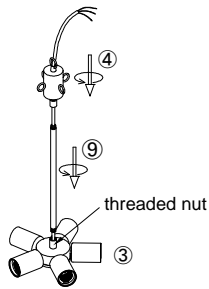

3. Let the wire of the fixture ③ go through the hanging tube ⑨ and metal part ④, rotate to install all parts together.

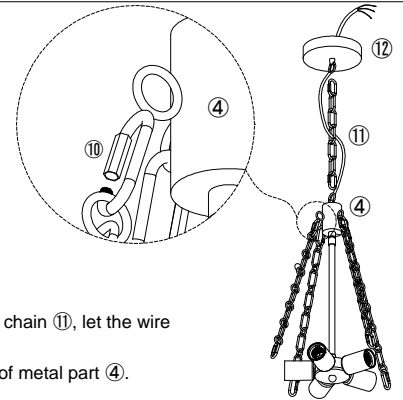

4. Hang the fixture to the canopy ⑫ with long chain ⑪, let the wire go through the chain ⑪ and canopy ⑫.
5. Install the shorts chain ⑩ to the small ring of metal part ④.

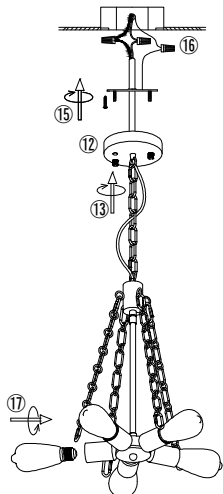

Loosen screw ⑤ to adjust tube ⑨ straight, after that rotate screw to make it fasten.

6. Install the bracket to the ceiling junction box with screw ⑮.
7. Connect the wire to the home line with cap connector ⑬.
8. Install the fixture to the bracket with cap nut ⑬.
9. Install the bulb ⑰.

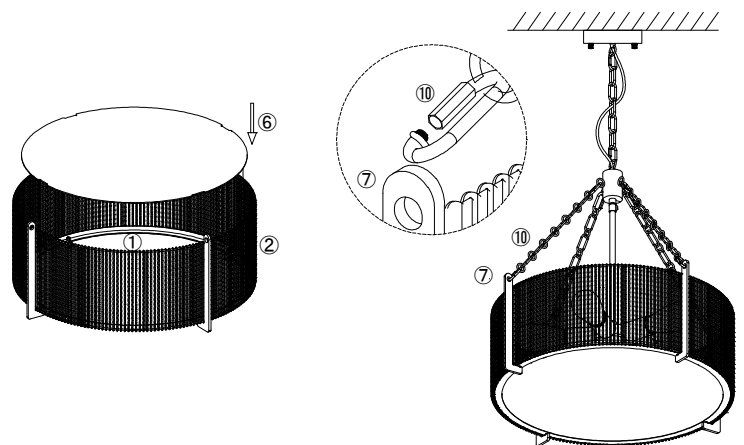

10. Put the bottom plate ⑥ into the lampshade ② and make it even.
11. Hang the lampshade ② to the fixture with small chain ⑩.

Please read carefully before installation!!!

Note : Please make sure that the electricity is powered off during installation !

Only a professional electrician should install this kind of product !