

**USER'S MANUAL**  
**Dual Wheel Wheelbarrow**

THIS INSTRUCTION BOOKLET CONTAINS **IMPORTANT** SAFETY INFORMATION. PLEASE READ AND KEEP FOR FUTURE REFERENCE.

--	--

## ! NOTICE

- Please do not exceed the weight limitations of this item.
- Use a hand or foot pump to inflate tires to a maximum of 25 PSI.
- Do not sit or ride in this wheelbarrow.
- Do not allow children to use this item unsupervised. This is not a toy.
- Always distribute the load evenly over the surface of the tray.
- Do not load weight on the edges of the tray.
- Do not operate in the vicinity of sharp or dangerous objects that could damage the tires.
- Do not stand on or use any part of this item as a step ladder.
- Firmly secure all bolts, screws and knobs before use.
- Reconfirm that all bolts, screws, and knobs are secure every 90 days.
- Be aware that some parts are heavy and have sharp edges.
- If any parts are missing, broken, damaged, or worn, stop using this product until repairs are made and/or factory replacement parts are installed.
- Do not use this item in a way inconsistent with the manufacturer's instructions as this could void the product warranty.

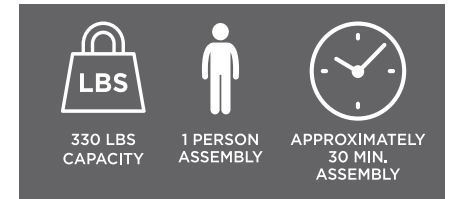

## TOOLS REQUIRED



NEEDLE NOSE  
PLIER



SMALL  
WRENCH



FLATEHEAD  
SCREWDRIVER



AIR PUMP

## HARDWARE

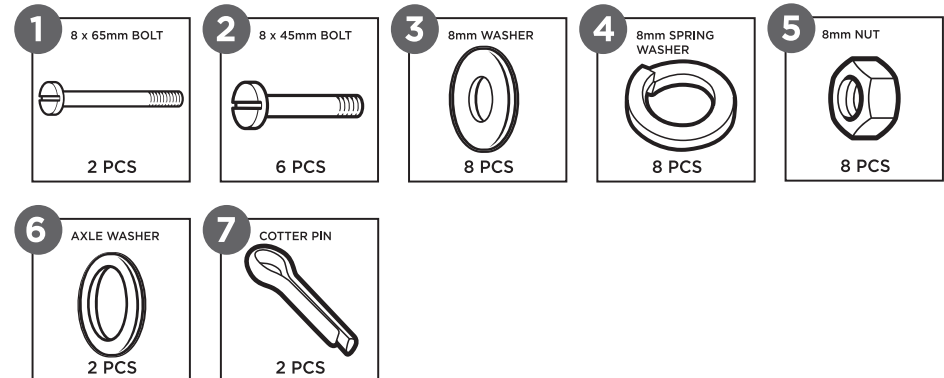

## PARTS

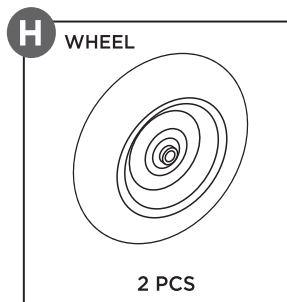
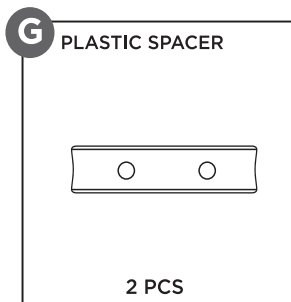
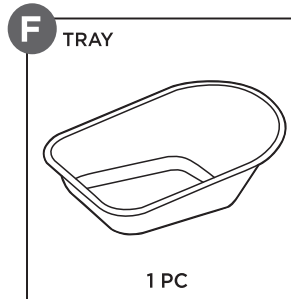
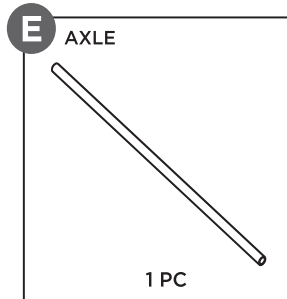
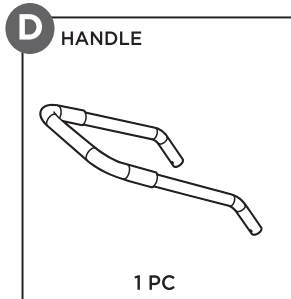
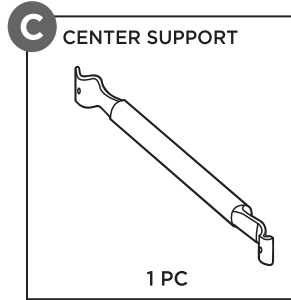
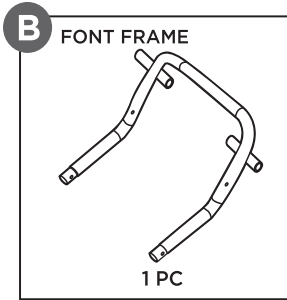
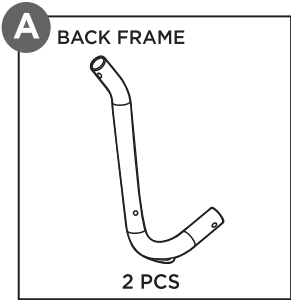

## PRODUCT ASSEMBLY

Please retain these instructions for future reference.

**1**

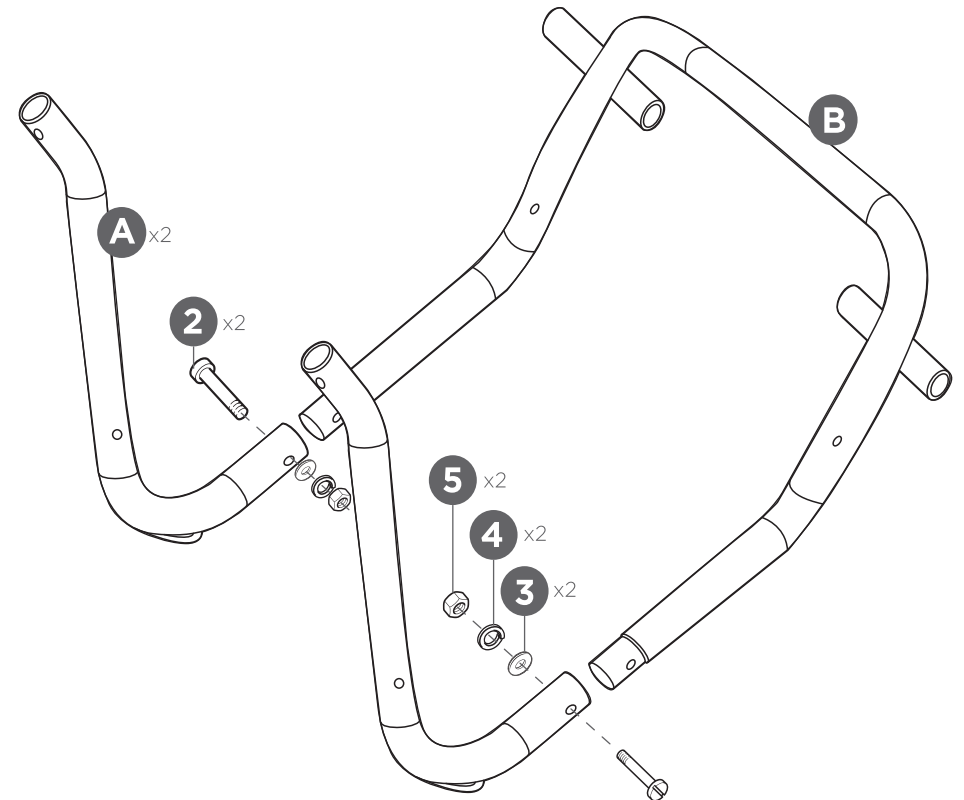

Attach the two part A back frames to the part B front frame with two part 2 bolts, two part 3 washers, two part 4 spring washers, and two part 5 nuts.

## PRODUCT ASSEMBLY

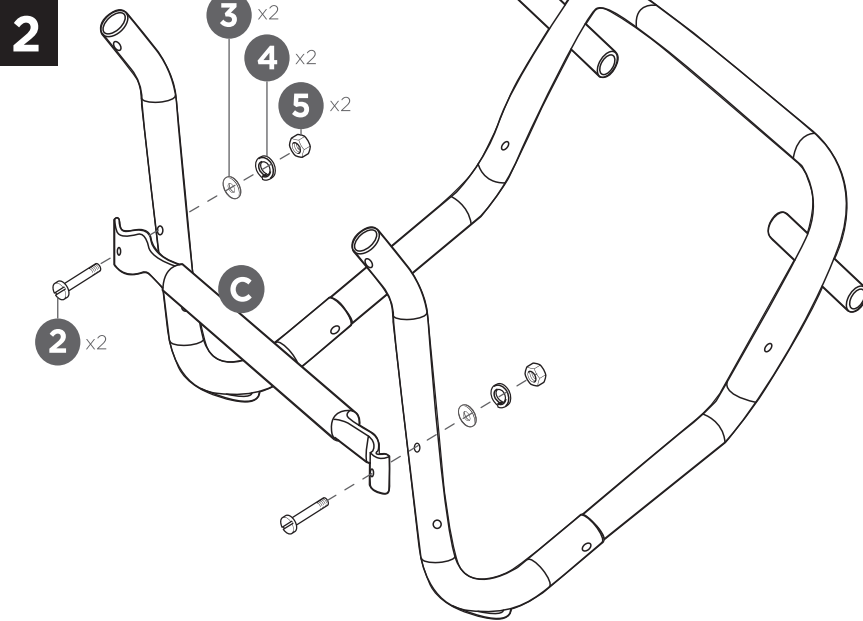

Attach part C center support with two part 2 bolts, two part 3 washers, two part 4 spring washers, and two part 5 nuts.

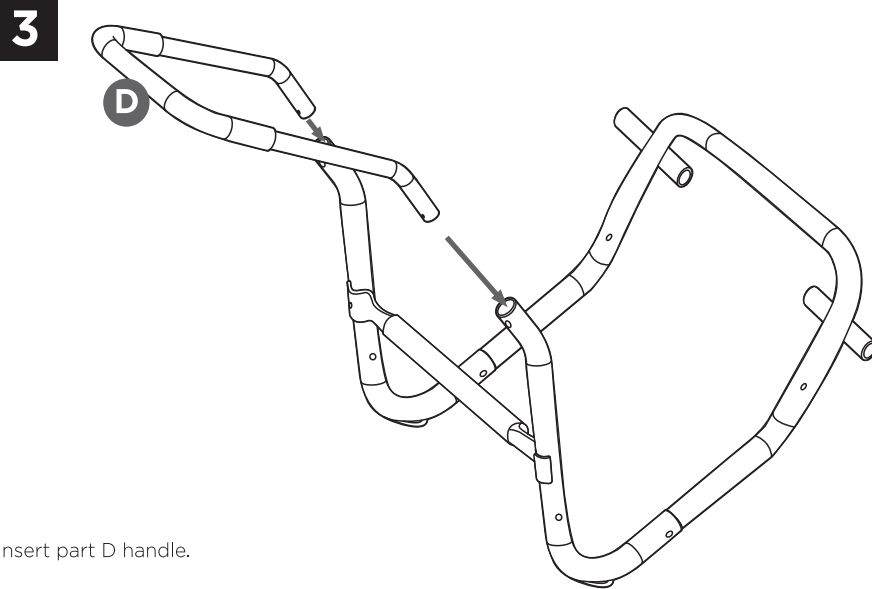

Insert part D handle.

6

## PRODUCT ASSEMBLY

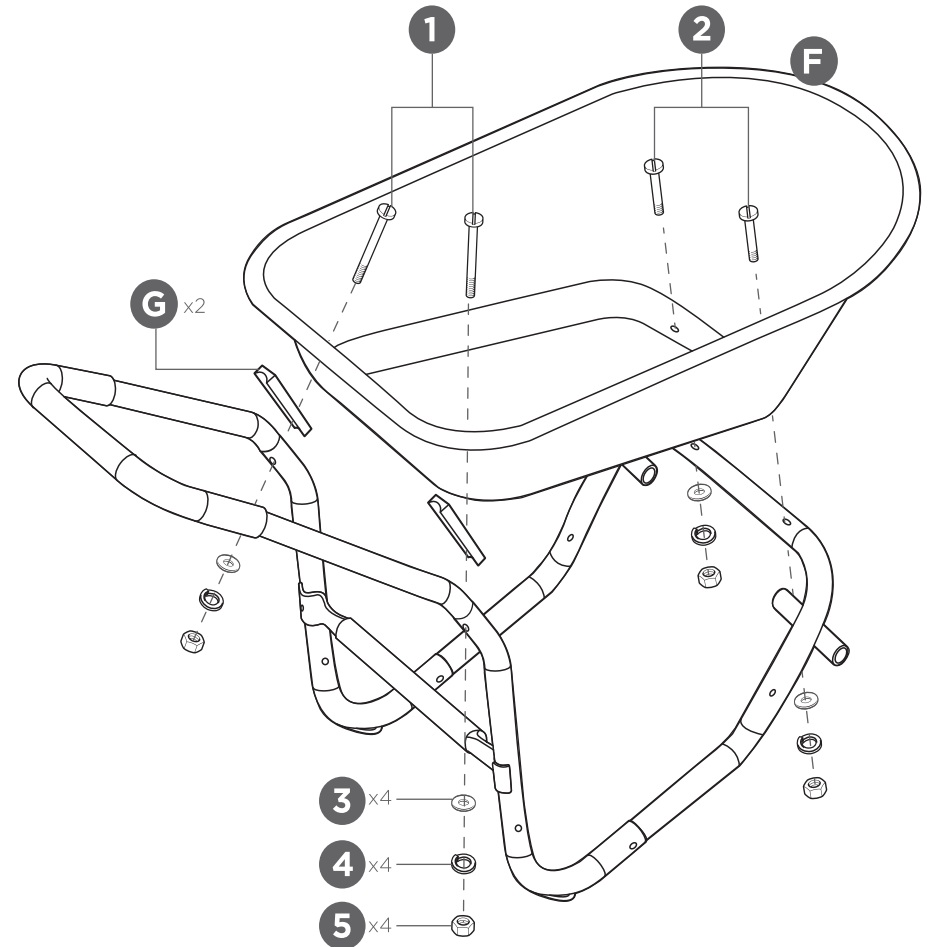

Attach the part F tray to the part B front frame with two part 2 bolts, two part 3 washers, two part 4 spring washers, and two part 5 nuts.

Place two part G plastic spacers between the tray and handle. Attach the tray to the handle with two part 1 bolts, two part 3 washers, two part 4 spring washers, and two part 5 nuts.

7

---

## PRODUCT ASSEMBLY

# 5

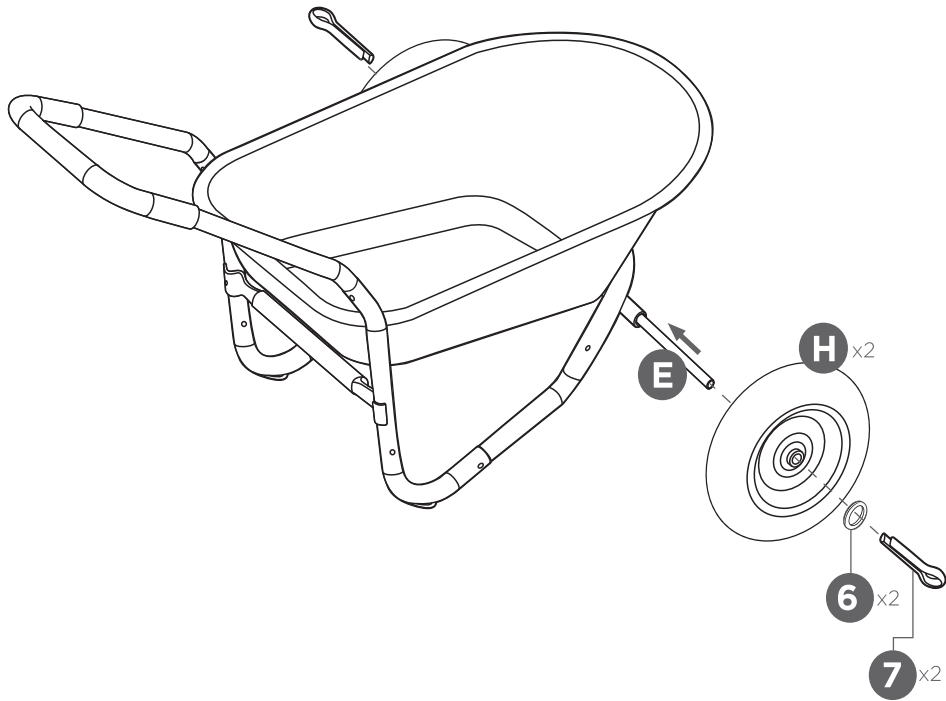

Use pliers to bend the pin and lock the wheel in place.

Slide the part E axle through the front frame.

Slide a part H wheel onto the axle and secure it with a part 6 axle washer and part 7 cotter pin. Repeat to attach the other wheel.

Use the air pump to inflate the wheels to a maximum of 25 PSI.